

# BreathSpec®



## User Manual



**G.A.S. Gesellschaft für  
analytische Sensorsysteme mbH**

# **BreathSpec® – User Manual**

**Version 4.81, April 2026**

**Valid from BreathSpec® Firmware Version 4.80**

All data, texts, designs, images and other elements used in this user manual are protected by copyright law. Any infringement may be subject to legal action.

Passing it on to third parties and producing copies of any kind or form – on the whole or in parts - is not permitted without written agreement of G.A.S. Any infringement may be subject to legal action.

G.A.S. reserves the right to realize technical changes to the product without explicitly mentioning them.

BreathSpec® is a registered trademark. Any infringement may be subject to legal actions.

**The BreathSpec® does not have a medical approval.**

CE-Marking according to:

**International Standard EN ISO 17050-1:2004**

**European Union Low Voltage Directive 2006/95/EC**

**European Union Electromagnetic Compatibility Directive 2004/108/EC**

**© Copyright 2026**

**G.A.S. Gesellschaft für analytische Sensorsysteme mbH  
44227 Dortmund - Germany**

**All Rights Reserved.**

**G.A.S. Gesellschaft für analytische Sensorsysteme mbH  
Otto-Hahn-Str. 15  
D-44227 Dortmund  
Germany**

**Phone: (+49) 231/9742-6550  
Fax.: (+49) 231/9742-6555  
E-Mail: support@gas-dortmund.de  
Internet: www.gas-dortmund.de**

## Table of Content

<b>1</b>	<b>General Information .....</b>	<b>6</b>
1.1	Information about the Manual.....	6
1.2	Explanation of Symbols .....	6
1.3	Notation for dialogs, elements and references .....	7
1.4	Scope of Supply BreathSpec® with Circular Gas Flow Unit.....	8
1.5	Scope of Supply BreathSpec® with Airsense $\mu$ TD Unit.....	14
1.6	Liability and Guarantee.....	18
1.7	Copyright.....	19
1.8	Return and Disposal .....	19
1.9	Software Updates .....	19
1.10	Customer Service.....	20
<b>2</b>	<b>Safety .....</b>	<b>21</b>
2.1	Intended Use Only.....	21
2.2	Responsibility of Operator .....	21
2.3	Requirements of Personnel.....	22
2.4	Dangers.....	23
<b>3</b>	<b>Transport, Packing and Storage.....</b>	<b>24</b>
3.1	Inspection after Transport.....	24
3.2	Packing.....	24
3.3	Storage and Transport.....	25
<b>4</b>	<b>Cleaning and Maintenance .....</b>	<b>25</b>
4.1	Cleaning .....	26
4.2	Maintenance.....	26
<b>5</b>	<b>Introduction .....</b>	<b>27</b>
5.1	Working principle of IMS technology .....	27
5.2	Purpose of the device.....	33
5.3	Internal gas flow and sample pump control .....	35
5.4	BreathSpec® Housing Device with Circular Gas Flow Unit.....	38
5.5	BreathSpec® Housing Device with Airsense $\mu$ TD.....	42
5.6	Device Type / Serial Number Plate.....	47
<b>6</b>	<b>Operating Interface.....</b>	<b>48</b>
6.1	Overview .....	49

## BreathSpec® – User Manual

6.2	Spectra Window .....	55
6.3	Sequence Window.....	58
6.4	Defaults Window.....	61
6.5	Substances Window .....	65
6.6	Programs Window .....	74
6.7	System Window.....	85
6.8	Error Information Window.....	113
6.9	Additional Dialogue Windows .....	114
<b>7</b>	<b>Installation BreathSpec® Device with Ciruclar Gas Flow Unit.</b>	<b>119</b>
7.1	Installation Requirements .....	119
7.2	Installing the device .....	120
7.3	Mounting the Mouthpiece holder .....	125
7.4	Connecting the Mouthpiece tube .....	126
7.5	Warm-up phase after device switch-on .....	130
7.6	Prepare the device for operation .....	132
<b>8</b>	<b>Installation BreathSpec® Device with Airsense <math>\mu</math>TD .....</b>	<b>137</b>
8.1	Installation Requirements .....	137
8.2	Installing the device .....	138
8.3	Warm-up phase after device switch-on .....	145
8.4	Prepare the device for operation .....	147
<b>9</b>	<b>System Operation (How to...)</b> .....	<b>152</b>
9.1	Measurement Requirements .....	152
9.2	Measurement Program.....	152
9.3	Breath Sampling via Handheld Breath Sampler .....	153
9.4	Breath Sampling via Disposable Breath Sampler.....	160
9.5	Exemplary Breath sampling with a sample bag .....	164
9.6	Measurement in Normal mode .....	166
9.7	Measurement in Simplified mode .....	168
9.8	Measurement in ID Input Mode .....	170
9.9	Manual Measurement Recording .....	172
9.10	Adjusting the gas type settings .....	173
9.11	Test Pump Flow Control .....	175
9.12	Calibrate Pump Flow Control.....	177
9.13	Adaptation of existing programs to the pump flow control .....	179
9.14	Create a Measurement Program .....	181

9.15	Start Sequence.....	183
9.16	Workflows: File Transfer Setup .....	186
9.17	Current Loop Setup (only available in Version 5G2) .....	195
9.18	Modbus TCP Setup .....	199
9.19	Start Cleaning mode.....	201
9.20	Start Standby mode.....	202
9.21	Remove the Housing Cover .....	203
9.22	Change Capillary Column.....	206
9.23	Change sample pump unit.....	212
9.24	Change high voltage circuit board .....	215
9.25	Change filter set CGFU .....	221
9.26	Firmware Upgrade.....	223
9.27	Creating diagnostic information for support .....	226
9.28	Packing for return transport.....	229
9.29	Manual modification of the sample description attribute.....	231
9.30	Sample line rinsing (optional) .....	233
<b>10</b>	<b>Appendix .....</b>	<b>236</b>
10.1	Technical data: BreathSpec®.....	236
10.2	Technical data: I/O Interface .....	239
10.3	Ionisation Source Specification.....	241
10.4	Technical drawing: Internal Gasflow.....	243
10.5	Current Loop Interface (optional).....	244
10.6	Modbus TCP Specification .....	245
10.7	Troubleshooting.....	249
10.8	Consumables / Spare Parts.....	261
10.9	Corresponding G.A.S. Documents and Tutorials.....	269
10.10	Table of Figures .....	270

# 1 General Information

## 1.1 Information about the Manual

This manual describes a safe and adequate handling of the device. Following the instructions of the indicated safety aspects and instructions as well as the national and/or local rules and general safety regulations concerning the prevention of accidents are absolutely imperative.

Before starting the work with the device read the manual completely and thoroughly particularly the chapter security and respective safety references. Assure that you/the operator comprehend the terms described.

The manual is part of the device. It must be stored together with and next to the device at any time.

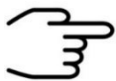

### **INFORMATION!**

The graphics in this user manual are schematic and may differ from the actual conditions. The firmware and PC software screenshots in this user manual may differ from the actual conditions.

## 1.2 Explanation of Symbols

Important and safety-relevant references in this manual are characterized by symbols. These indications which are in-line with industrial safety must be respected and followed at any time.



### **INFORMATION**

This symbol calls information, which are to be considered for efficient and perfect handling of the equipment.



### **WARNING**

This symbol indicates references, which can lead to damages, malfunctioning and/or loss of the device.



### **DANGER**

This symbol marks references, which can lead to health impairments, injuries, lasting body damages or to death due to electric current.

**DANGER**

This Symbol marks paragraphs, which describe potential dangers and damage due to exposure to radioactive radiation.

**DANGER**

This symbol marks references, which describe working procedures that demand special attention to avoid spreading of biohazard

**WARNING**

This symbol marks references, which can lead to health impairments, injuries due to pinching.

**DANGER**

This symbol marks paragraphs, which describe situations in which surface parts of the device can heat up to a point where touching it or bringing objects close to it may be hazardous.

### 1.3 Notation for dialogs, elements and references

#### Example Dialog:

**System** › **Connections** › **LAN File Transfer** › **Settings...** › **Test Connection**

#### Example Elements:

**Gas Out**, **Sample gas in**

#### Example: References

**Advanced User Manual**, **Chapter 5.1 Installation Requirements**

#### Example: Information

**keep the transport box**

**1.4 Scope of Supply BreathSpec® with Circular Gas Flow Unit**

Assure that you have received the full scope of supply, verify by checking the packaging list. If there is any part missing, please contact the GAS-hotline immediately.

**Standard Scope of Supply**



BreathSpec® Device (1 piece) including connected Circular Gas Flow Unit (CGFU) (1 piece)



Power supply with power plug (1 piece)



Mouthpiece Handheld holder arm with screws

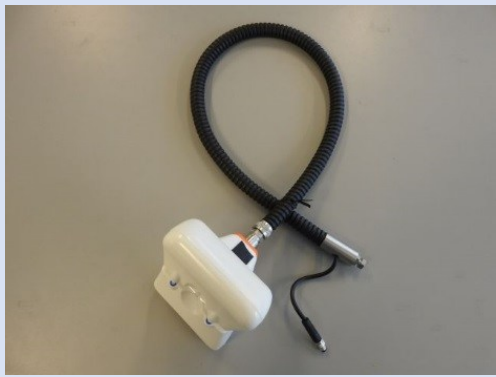

Mouthpiece Handheld with  
heatable Transfer Line (1 piece)



**BreathSpec® Gas tube Kit (installed)**

- Driftgas/Carriergas Adapter (1 piece)
- 0,6 m 3 mm PFA Tubes with 3 mm Swagelok-Connector (2 pieces)



CGFU Connection cable (installed) (1 piece)



LAN Cable (1 piece)



**Disposable Breath Reservoir Kit**

- Mouthpieces (100 pieces)
- Reservoir tube (100 pieces)



Inner Syringe Body (2 ml syringe)  
(50 pieces)



Sampling Syringe (5 ml syringe)  
(100 pieces)



BreathSpec® Blind plug Set (5 pieces)  
(Swagelok 3 mm Blind plug with red cap  
installed on device connectors)



### Torx Tool Kit

- Torx Screwdriver 8 mm (1 piece)
- Torx Screwdriver 10 mm (1 piece)
- Torx Screwdriver 30 mm (1 piece)



### Document Map with Documents and Device User Manuals (1 piece)



### USB-Stick Box with Software und Documents (1 piece)



### Custom Ketones Standard (1piece)

**BreathSpec® – User Manual**



Transport box (1 piece)

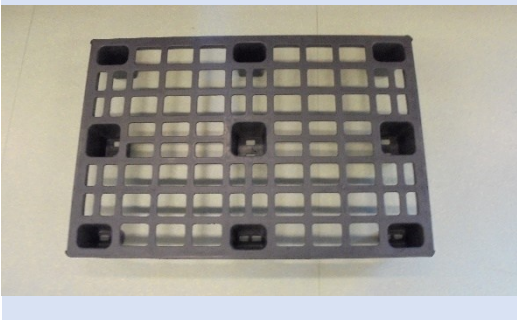

BreathSpec Transport pallet (60 x 80 cm)  
(1 piece)

Optional Scope of Supply (only available if ordered)



Laptop Computer (model might be different than shown) including software for control and evaluation.

(optional)



**CGFU-Filter Set**

(2x Moisture-Trap, 1x Hydrocarbon-Trap)

(optional)

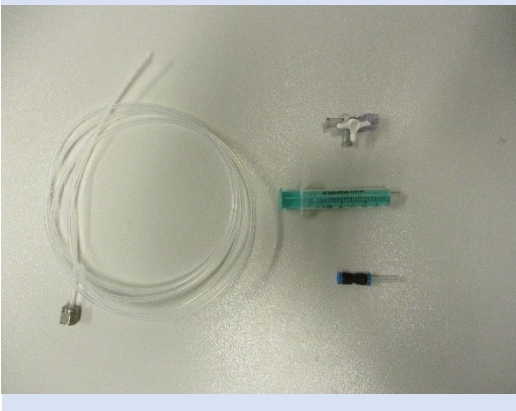

**Sample line rinsing Set**

(1x 2 m 3 mm PFA Tubes with 3 mm Swagelok-Connector; 1x Disposable Syringe, 1x 3-Way-Stopcock with Luer-Lock-Adapter, 1x Festo-adaptor 3 to 4 mm with 4 mm tube)

## **1.5 Scope of Supply BreathSpec® with Airsense $\mu$ TD Unit**

Assure that you have received the full scope of supply, verify by checking the packaging list. If there is any part missing, please contact the GAS-hotline immediately.

### **Standard Scope of Supply**



BreathSpec® Device (1 piece)



$\mu$ TD with accessories (1 piece)



Power supply with power plug (1 piece)



**BreathSpec® Gas tube Kit**

Driftgas/Carriergas/ $\mu$ TD Adapter (1 piece)

- 2 m 3 mm PFA Tubes with 3 mm Swagelok-Connector (4 pieces)



Molecular sieve trap (200 ml)  
(1 piece)



LAN Cable (1 piece)



BreathSpec® Blind plug Set (7 pieces)

(Swagelok 3 mm Blind plug with red cap installed on device connectors)

# BreathSpec® – User Manual



## Torx Tool Kit

- Torx Screwdriver 8 mm (1 piece)
- Torx Screwdriver 10 mm (1 piece)



## Document Map with Documents and Device User Manuals (1 piece)



## USB-Stick Box with Software und Documents (1 piece)



## Custom Ketones Standard (1piece)

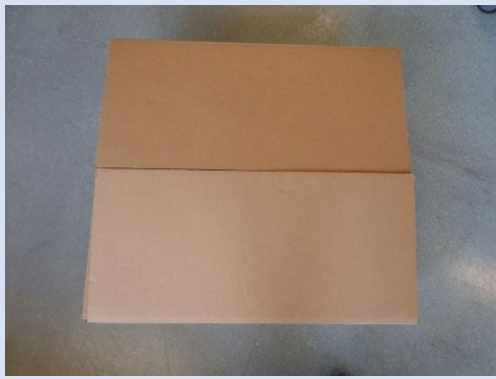

Transport box (1 piece)

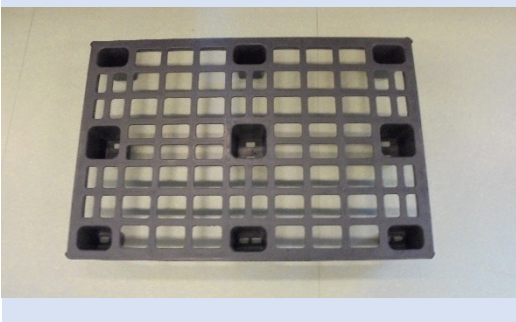

BreathSpec Transport pallet (60 x 80 cm)  
(1 piece)

Optional Scope of Supply (only available if ordered)

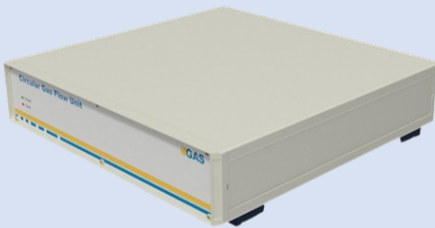

Circular Gas Flow Unit with accessories  
(optional)



Nitrogen Generator with accessories  
(example picture)  
(optional)

## BreathSpec® – User Manual



Laptop Computer (model might be different than shown) including software for control and evaluation.

(optional)



Sampling Syringe 5 ml syringe for Luer Adapter) (100 pieces)

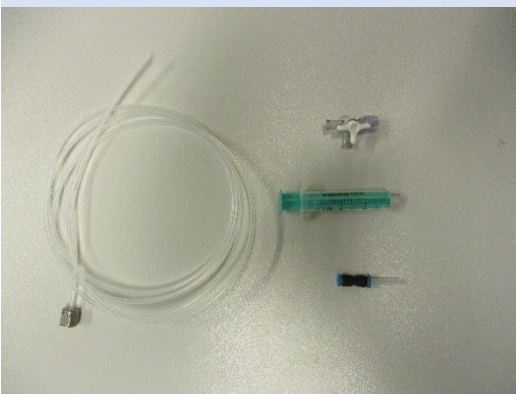

### Sample line rinsing Set

(1 x 2 m 3 mm PFA Tubes with 3 mm Swagelok-Connector; 1x Disposable Syringe, 1x 3-Way-Stopcock with Luer-Lock-Adapter, 1x Festo-adaptor 3 to 4 mm with 4 mm tube)

## 1.6 Liability and Guarantee

This user manual describes the safe and proper handling of the device.

All data and reference within this manual are compiled under the valid regulations, the state-of-the-art as well as G.A.S. experiences of several years.

This user manual must be stored together with and close to the device at any time and accessible to all persons, who operate or handle the device at any time.

This user manual must be read carefully before starting to work with the device. G.A.S. does not assume any liability for damage and disturbances, resulting from disregard of the instructions contained in this user manual. All claims of any kind related to damage from a not intended use of the device will be rejected.

G.A.S. reserves the right to realize technical changes of the product due to improvements without explicitly mentioning them.

### **1.7 Copyright**

The manual is confidential. It is beyond doubt exclusively made and also meant for the personnel directly dealing with the equipment. All data, texts, designs, pictures and other representations within this manual are protected in the sense of the copyright law and are subject to further commercial patent rights. Each abusive is punishable by law.

Passing it on to third persons as well as duplications in any kind and form - also in part - as well as the use and/or report of contents are not permitted without written agreement of the manufacturer. Offences lead to payment of damages. We reserve ourselves all rights of the practice of commercial patent rights.

### **1.8 Return and Disposal**

For an adequate disposal, the device or/and its equipment must be returned to the G.A.S. or to a third party authorized by the G.A.S.! For questions, please contact G.A.S.

### **1.9 Software Updates**

If there are any software updates customers will be contacted by G.A.S. Gesellschaft für analytische Sensorsysteme mbH as soon as the updates are available. The updates are free of charge within the first 12 months after delivery. Users will be provided with information about the changes and instructions for executing the updates.

## **1.10 Customer Service**

For questions concerning G.A.S. products a customer service is available:

G.A.S. Gesellschaft für analytische Sensorsysteme mbH

Otto-Hahn-Straße 15

44227 Dortmund

Germany

Phone: +49 (0) 231 / 97 42 - 65 50

Fax: +49 (0) 231 / 97 42 - 65 55

[support@gas-dortmund.de](mailto:support@gas-dortmund.de)

The telephone hotline is available from Monday to Friday from 9:00 to 16:00 hours. In urgent cases or if you use fax or email please provide a telephone number for callbacks.

## 2 Safety

### 2.1 Intended Use Only



#### **WARNING!**

Usage other than described in this manual may damage the device and/or harm persons involved.

Do not use the device for other purposes. Damages due to misuse are not covered by the guarantee. Such damage claims will be rejected.

The device and its equipment are not certified for the employment in areas with explosive gas air mixtures.

All claims or requirements of any kind against the manufacturer and/or its authorized persons that arise due to damages from a not intended use of the device will be rejected. All damages that arise from a not intended use are of the operator's responsibility.

The intended use of the equipment and its correct handling according are described in the operating instructions of this manual. Other parts than the parts belonging to the scope of supply, may only be used after G.A.S. approval.

### 2.2 Responsibility of Operator

The device may only be operated in a perfect technical condition. Before putting the device into operation, the condition of the device and its equipment must be checked. The information and instructions provided in this manual must be followed at any time.

Besides the instructions provided in this manual the local rules for the prevention of accidents, general safety regulations - valid for the area of application of the device - as well as the valid environmental-protection regulations must be considered and respected.

The responsible technicians and operators must make sure a failure-free use of the device. Responsibilities among the involved persons regarding installation, operation, maintenance, and cleaning must be made clear.

The device can be used to analyse human breath. A hygienic operation must be always ensured. Ensure that human breath analysis does not conflict with local

ethical compliance. The breath analysis data might imply private information covered by data privacy protection that has to be obeyed.

### 2.3 Requirements of Personnel

Only authorized and trained technical personnel may work with the instruments. The operator must have received an instruction over existing and all possible dangers and should be regularly instructed in safety procedures and environmental protection and that the personnel is fully aware of the complete operating instructions and particularly the safety notes. Personnel that might be under the influence of drugs or alcohol are to be kept off the device at any time.

Technical personnel in this context are defined as skilled employees who are knowledgeable due to their educational background. In case the foreseen personnel do not have the necessary qualifications to operate the instrument, it must be trained. Further to that non-authorized personnel should not operate the device.

The competencies for the work on and with the device must be specified and kept undoubtedly at any time so that with respect to security issues no unclear situation might come up.

Any changes of the equipment, which impair security of the personnel, must immediately be reported to the operator and every person dealing with it.



#### INFORMATION!

- Operators must be aware of local hygienic standards.
- Operators must be aware of local ethical compliances regarding human breath analysis.
- Operators must be aware of local privacy protection compliances.

## 2.4 Dangers

The device and its equipment are subject to an endangerment analysis. The construction and execution of the device corresponds to the today's state-of-the-art. The device is reliable in service when operated according to its intended use.



### INFORMATION!

If the housing of the device is damaged, the device must not be used anymore and must be returned to the G.A.S. by using the original transportation case.



### DANGER

The BreathSpec® device contains a radioactive radiation Tritium source which in all EURATOM countries is below the exemption limit of 1 GBq for tritium acc. to Table B (column 2) of Article 26, of the Directive 2013/59 EURATOM of December 5th, 2013.

However, do not open the device! Do not try to recover malfunctions of the device! Malfunction recovery, repairs and any maintenance work may only be performed by G.A.S. or by qualified personnel authorized by G.A.S.



### DANGER

The BreathSpec® and its equipment is not certified for the employment in areas with explosive gas air mixtures (Zone 0).



### DANGER

Exercise great care in handling current-carrying parts like the power supply cord. Do not get directly in touch with current-carrying parts. Do not open the housing. Do not use damaged parts.



### DANGER

All parts of the equipment that are in contact with human breath must either be disposed of or sanitized to prevent biohazard



### DANGER

When Nitrogen is used as drift gas and helium as carrier gas, ignition of a helium plasma may occur due to the high voltage present in conjunction with a radiation source. This can damage the IMS.



**DANGER**

This symbol marks paragraphs, which describe situations in which surface parts of the device can heat up to a point where touching it or bringing objects close to it may be hazardous.

### 3 Transport, Packing and Storage

#### 3.1 Inspection after Transport

Check the supply immediately after delivery concerning its completeness and/or transport damages. If you detect externally visible transport damage, do not receive the supply, or only under reservation. State the extent of the damage on the provided delivery note and/or the transportation documents of the feeder. Generate a complaint. Log a complaint of covered defect immediately after recognizing, as claims due to transport damages can only be made valid within the complaint periods (usually 7 days).

#### 3.2 Packing

If no return agreement regarding the packing was agreed upon dispose the packaging material always in an environmentally friendly way and according to valid local regulations. If necessary, ask a recycling company.

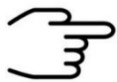

**INFORMATION!**

It is recommended to **keep the transport box** for a safety return transport.

### 3.3 Storage and Transport

Store the device only under the following conditions:

- **When not in use store the equipment in the supplied casing**
- **Prevent unauthorized access**
- **Do not store outside**
- **Protect the equipment from moisture and dust**
- **Put protective caps on all gas sockets**
- **Avoid mechanical vibrations**
- **Do not expose the equipment to aggressive substances**
- **Protect the equipment from direct sun light**
- **Storage temperature: 5 to 40°C**
- **Relative Air Humidity: 0- 90% RH, prevent condensing**
- **Instrument's position: Horizontal**

The equipment should be moved only within the provided carrying case. By this means, transport damages can be avoided. The above-mentioned values are considered for an instrument transported in its original new packing.



#### **WARNING!**

Protective caps should be put on gas sockets in case the device is stored or transported.

## 4 Cleaning and Maintenance

Natural aging and the wear of certain components of the equipment require a regular cleaning and maintenance.

## 4.1 Cleaning

Clean the device only with a dry or easily damp cloth.



### **WARNING!**

Do not use cleaning agents, which contain solvents, acids or bases.

## 4.2 Maintenance



### **INFORMATION!**

Maintenance of the device should only be carried out at G.A.S. or through specially trained and by G.A.S. authorized personnel.

The recommended **maintenance interval** for **BreathSpec®** device is **12 months** for **Circular Gas Flow Unit (CGFU)** is **6 months**.



### **INFORMATION!**

Maintenance of the equipment must be carried out by G.A.S. or personnel authorized by G.A.S.

Please contact G.A.S. 6-8 weeks in advance to optimize the turn-around time!

## 5 Introduction

### 5.1 Working principle of IMS technology

Ion Mobility Spectrometry (IMS) is an analytical technology to separately detect gaseous compounds in a mixture of analytes. The separation is based on the specific drift times, that ionized compounds need to pass a fixed distance (drift tube) in a defined electric field.

$$\text{Drift velocity: } v_d = KE$$

$$\text{Mobility: } K = \frac{L^2}{t_D U}$$

$$K = \frac{3}{16} \sqrt{\frac{2\pi}{\mu kT}} \frac{Q}{n\sigma}$$

$Q$	<i>ion charge</i>
$n$	<i>drift gas number density</i>
$\mu$	<i>reduced mass of the ion and the drift gas molecules</i>
$k$	<i>Boltzmann constant</i>
$T$	<i>drift gas temperatures</i>
$\sigma$	<i>ion's collision cross section with the drift gas</i>

Figure 1: Ion Mobility Spectrometer - Basic Relations

Compared to other techniques e.g. TOF-MS, ions travel at atmospheric pressure versus a flow of inert drift gas. The drift time of each substance is determined by its ion mass and geometric structure, as slowing collisions with the drift gas molecules are more frequent for sterically demanding structures. Therefore, IMS can even differentiate isomeric molecules. For detection, the resulting ion current is measured by an electrometer as a function of time.

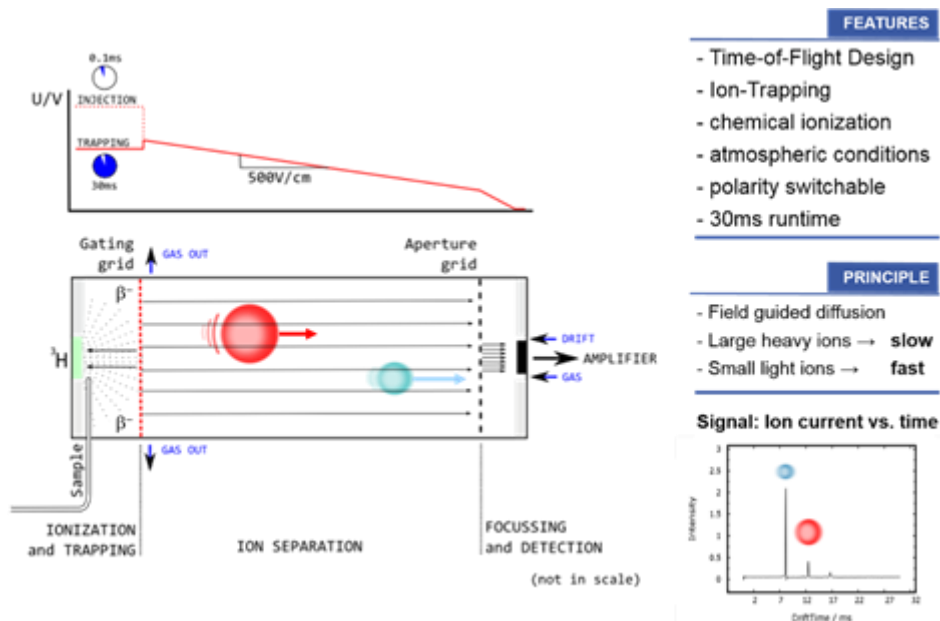

Figure 2: Ion Mobility Spectrometer -Working Principle

Atmospheric Ionization of molecules can be obtained by several techniques. G.A.S. uses photoionization with a 10.6eV UV-lamp or soft chemical-ionization initiated by a low-radiation tritium ( $^3\text{H}$ ) source (below exemption limits of EURATOM). While the first directly produces positive ions, the latter generates *reactant ions* with the gas atmosphere by a cascade of reactions following the collision of a fast electron emitted from the  $\beta$ -radiator  $^3\text{H}$ . The so-called Reaction Ion Peak (RIP) representing the total of all ions available is formed as a first step. In nitrogen and air, resp., the *reactant ions* can be described as  $\text{H}^+(\text{H}_2\text{O})_n$  and  $\text{O}_2-(\text{H}_2\text{O})_n$ . Chemical ionization of analytes by *reactant ions* then result in the formation of specific analyte ions, when the affinity of the analyte towards the reactant ion is higher in case compared to water (using the positive ionization mode). The proton affinity of water is 691kJ/mol, so all molecules with a higher proton affinity will be ionized by a proton transfer, which is typically given for all heteroatom-organic compounds. The ionization takes place at ambient pressure, so that the analyte concentration is not diluted as compared to other analytical methods where a vacuum must be applied. Therefore, IMS is extremely sensitive. The detection limits typically are in the low ppb-range for *volatile organic compounds (VOC)*.

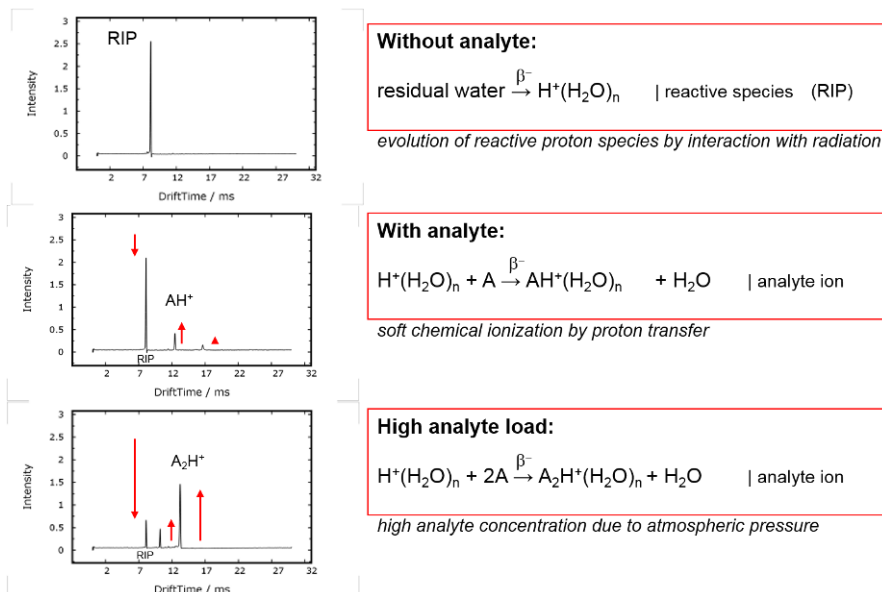

Figure 3: IMS Predominant Ionization (positive polarization)

The above figure exemplarily shows typical IMS spectra without analyte and with analyte. The RIP is formed as a sharp signal proving the cleanliness of the system and at a specific position that is used as internal standard. The spectrum containing analytes shows a decreased RIP, while new (analyte) peaks are correspondingly formed. The drift time is specific to an ion; therefore, analyte identification is possible. The peak height and area correlate to the analyte concentration, so that a quantification is also possible.

<b>Proton Affinities</b>	Aromatic Amines	930.0 KJ/mol	Pyridine
	Amines	899.0 KJ/mol	Methyl Amine
	Phosphorous Compounds	890.6 KJ/mol	Trimethylphosphate
	Sulfoxides	884.4 KJ/mol	Dimethyl Sulfoxide
		853.6 KJ/mol	Ammonia
	Ketones	832.7 KJ/mol	2-Pentanone
	Esters	821.6 KJ/mol	Methyl Acetate
	Alkenes	805.2 KJ/mol	1-Hexene
	Alcohols	789.2 KJ/mol	Butanol
	Aromatics	750.4 KJ/mol	Benzene
		<b>691.0 KJ/mol</b>	<b>Water</b>
	Alkanes	543.5 KJ/mol	Methane

Source: Gary Eiceman & Zeev Karpas, *Ion Mobility Spectrometry*, CRC Press, 2005, ISBN 0-8493-2247-2

Proton affinities of various VOCs can be found at the NIST chemistry webbook  
<http://webbook.nist.gov/chemistry/>

Figure 4: Proton Affinities of VOC's

Complex analyte mixtures, like e.g. food flavours, often demand a second and independent separation step to separately analyse the multiplicity of compounds at low concentrations. Therefore G.A.S. -according to application- equips its IMS systems with gas chromatographic (GC) columns. The volatile compounds of samples under testing are pre-separated in time by a GC column. The discrete compounds are consecutively fed into the IMS ionization chamber, so that analyte and/or ion interactions are avoided.

Furthermore, a competition of analytes on the reactant ions is excluded, enhancing the sensitivity of the system for individual compounds.

The GC-IMS setup enables a twofold separation of analyte mixtures and the detection by the IMS electrometer. Since the IMS measurements are extremely fast (30ms / spectrum) a continuous and high-resolution recording of analyte signals is provided.

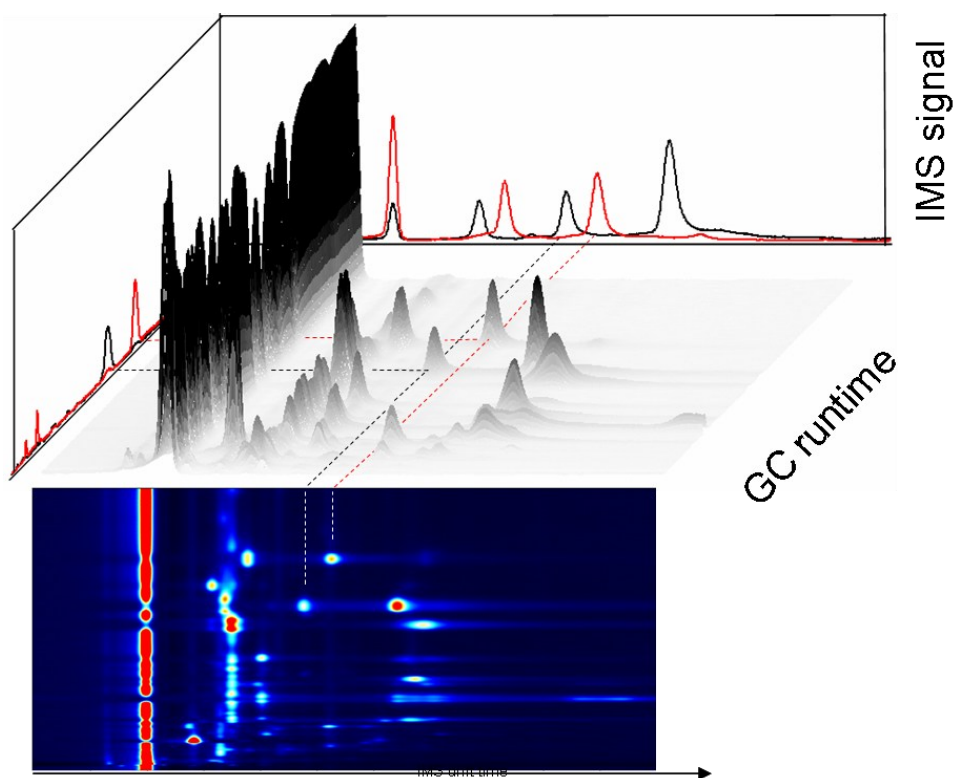

Figure 5: GC-IMS measurement 3D

The above figure sketches the GC-IMS measurement's 3D-dataset and the corresponding heatmap visualization.

## FOCUS-IMS®

The FOCUS-IMS is designed to optimize detection and mapping of fast temporal changes in sample feed. This is especially important for systems where IMS is coupled to temporal pre-separation techniques, like gas chromatography.

FOCUS-IMS's sample feed is guided straight onto the ionization source, which is mounted self-supporting perpendicularly to IMS drift tube. This ensures immediate ionization and detection of analyte molecules. Subsequent sample wash-out is ensured by wide exhaust pathways in-line to the drift gas flow and is driven by both consecutive carrier gas- and the drift gas flow.

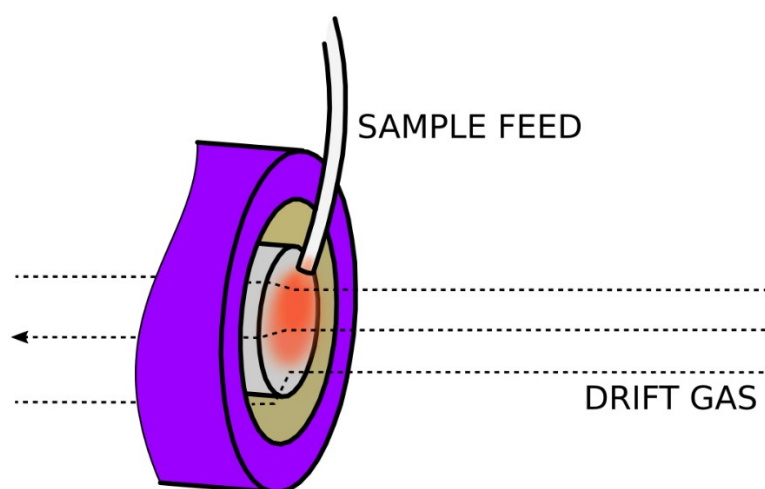

Figure 6: Schematic of the sample- and drift gas flow paths

The inherent detector's void volume is built by a 'bubble' of sample feed (carrier gas flow) in interplay with the drift gas flow. This 'virtual' void volume is smaller than the geometrical volume and is characterized by a decreased sample dwell time and subsequent to better detector signal mapping of changes in the sample feed. When coupled to gas chromatography a signal peak tailing due to residual sample is decreased.

Drift gas flows become a relevant parameter for the FOCUS-IMS. High drift gas flows reduce sample dwell time and hence reduce the respective detector sensitivity. This can be utilized to tune the IMS response dynamically. The following image plots the chromatogram of the subsequent measurements of a homologous series of linear 2-ketones (#C 4-9). Drift gas flows are 50 - and 150 ml/min (left- and right-hand chromatogram). The chromatogram plotted in centre runs a drift gas flow of 150 ml/min and switches to 50 ml/min in a distinct run time (here: 2-heptanone).

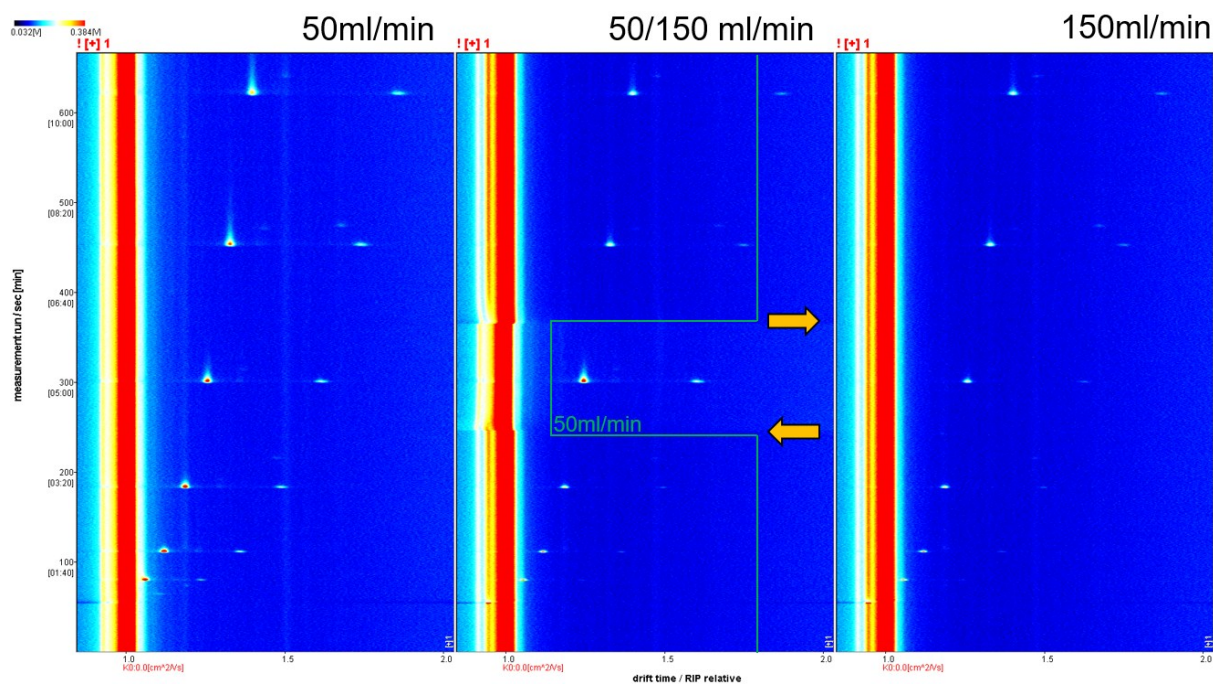

Figure 7: Chromatograms of 2-ketones (C 4-9) for varying drift gas flows

Reduced drift gas flows increase the signal peak heights. Dynamic change of flows within a GC run is possible to selectively tune sensitivity.



### INFORMATION!

The drift gas flow is a relevant parameter for FOCUS-IMS® systems: **Elevated drift gas flows** will enhance temporal signal peak mapping and will reduce peak tailing.

**Lowered drift gas** flows will increase detector response and sensitivity

Reasonable starting value for drift gas flows in method development is 75 ml/min.

## 5.2 Purpose of the device

The BreathSpec® represents the synergies of a fast gas chromatograph and the outstanding sensitivity of an IMS. Thus, traces of Volatile Organic Compounds (VOCs) even in highly humid matrices like the human breath become detectable without any special sample preparation. Its intended purpose is to:

**Measure traces of volatile organic compounds in exhaled air of humans.**

The device allows sampling of human breath directly by sucking in breath exhaled in a handheld breath sampler. The handheld sampler is equipped with disposable mouthpiece, sampling tube and sampling tip to minimize possible carry over of microbes. Furthermore, the device can be equipped with a Luer port to accept samples collected breath in a common disposable syringe. Sampling into a syringe - aside from the device - can be done using a fully disposable breath sampling setup.

Results are available within a few minutes and compounds are typically detectable even at ppb<sub>v</sub>-/ppt<sub>v</sub>-levels. The technical configuration, its menu as well as its extremely easy.



### WARNING!

The BreathSpec® device must not be operated by introducing aggressive gases or any kind of liquids or solids. The operational reliability is only ensured when the equipment is applied for this intended purpose.



### INFORMATION!

Any use of the device, that differs from the intended purpose will be regarded as “out of purpose”. Any claims of any kind against G.A.S. or her associates that are related to damages from a use not covered by the aforesaid will be rejected.

The BreathSpec® contains several parameterized components that can be modified for optimizing measurement data in terms of separability of substances and clarity of resulting peaks.

The BreathSpec® can be operated in negative or positive drift voltage mode. The reactant ion peaks (RIPs) and analyte ion peaks (AIPs) in the positive drift voltage mode will be displayed as maxima in the spectra. In the negative drift voltage mode both will be shown as minima. One of these modes may be more suitable for specific substances.

## BreathSpec® – User Manual

Measurement data can be acquired by employing user-defined measurement programs. In these programs the operational parameters of various components of the BreathSpec® can be modified at defined sequences of the measurement run. Measurement data can also be acquired in a manual way using the “Recording” mode.

Acquired measurement data are stored in measurement files either on the internal storage volume of the BreathSpec® or – when activated – in a shared network folder. Stored measurement files can further be copied to a connected USB volume.

For using a shared network folder, the BreathSpec® can be integrated into a local area network (LAN) by using the Ethernet socket at the rear side of the device.



### **INFORMATION!**

**The BreathSpec® does not have a medical approval.**

### 5.3 Internal gas flow and sample pump control

The schematic drawing shows the principal structure of the gas flow system of the BreathSpec® is shown. The system consists of the IMS coupled to a gas chromatographic column.

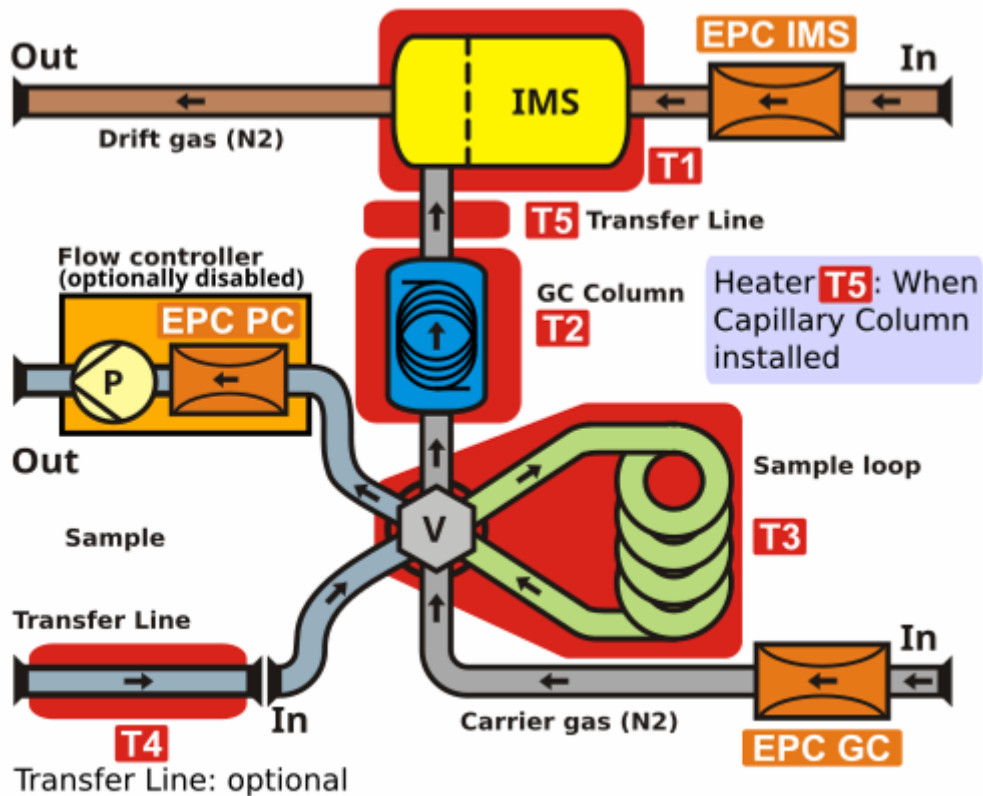

Figure 8: BreathSpec® device plan (exemplary)

The gas supply comes from a coupled circular gas flow unit and supplies the system with purified air. The drift gas for the IMS is supplied using an electronic pressure control unit (**EPC IMS**). The carrier gas for the column is supplied using a second electronic pressure control unit (**EPC GC**). Both gases (carrier and drift gas) leave the device at the gas out and goes back again into the circular gas flow unit (Gas In).



#### INFORMATION!

To ensure correct measurements it is necessary to **connect the supplied exhaust tube** (Sample gas out).

The exhaust tubes (Gas out and Sample gas out) **must be led separately into the exhaust system and must not be connected together**.

The exhaust system must **not generate any negative pressure**.



**INFORMATION!**

The sample pump is EPC-monitored and controlled (**EPC PC**). After installing the device, the pump control parameters should be tested and recalibrated if necessary. Changing environmental parameters (e.g. changing sample tube lengths) requires a calibration of the parameters. **(see workflows Test and calibrate sample pump control)**

IMS (T1), GC-Column (T2), 6-Port Valve with sample loop (T3) and Transfer Lines (T4 and T5) are heated.

The gas sample is introduced into the System by sucking it into the sample in port at the front of the housing.

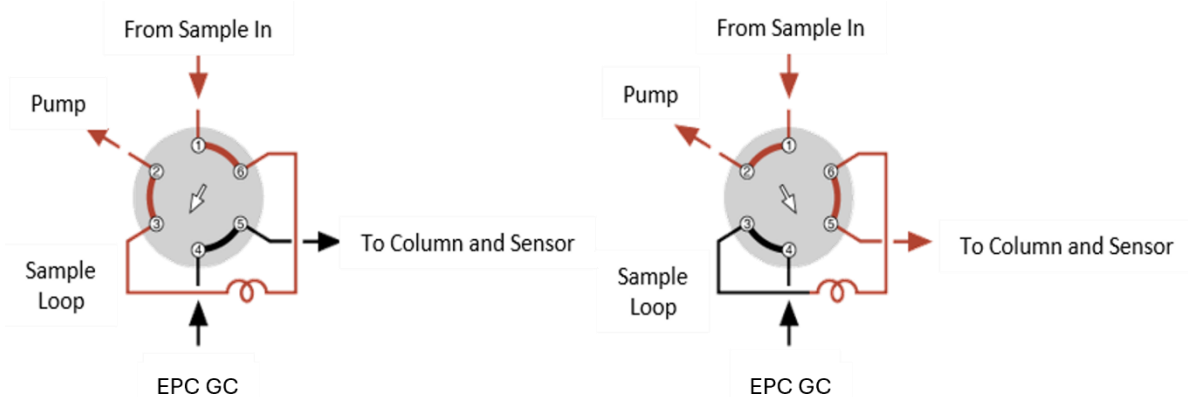
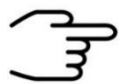

Figure 9: Six-Port Valve - Position Fill Loop and Inject

The sample is transferred via the heated 6-port-valve (T3) to the GC-Column. In the default position of the 6-port-valve the carrier gas permanently flushes the multi capillary column. The sample gas is pumped through the loop by the pump *P*. This phase is called “Fill Loop”. In this position the sample gas from the Sample In socket is directly routed to the Sample Out socket.

For routing the sample gas in the loop to the GC-Column and to the IMS, the 6-port-valve is switched to the second position. The carrier gas now transports the sample gas into the loop and further to the GC-Column, where the substances in the sample gas are separated by time. The eluting substances are introduced into the ionization region of the IMS and leave the system via the Gas Out socket.

The carrier gas stream now transports the sample gas to the GC-column, where the substances in the sample gas are separated by time. The eluting substances are introduced into the ionization region of the IMS and leave the system via the Gas Out socket.



**INFORMATION!**

In the event of a power failure, check the position of the valve position. The basic setting must be set to **Fill Loop**.

## 5.4 BreathSpec® Housing Device with Circular Gas Flow Unit

### 5.4.1 Front

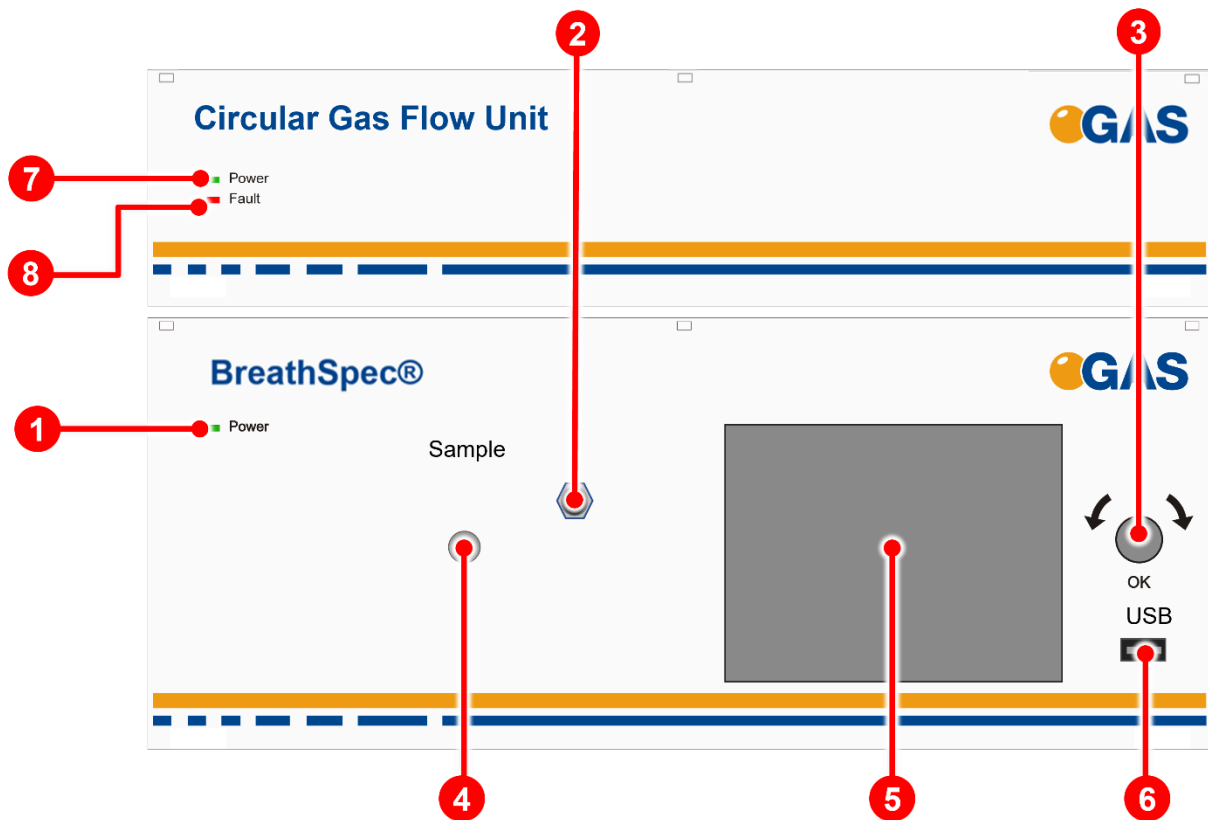



Figure 10: BreathSpec® (Version 5G1) - Housing of device - Front

<p><b>1</b></p>	<p><b>Power LED</b></p>	<ul style="list-style-type: none"> <li>■ Indicates whether or not the device is connected to a power supply and is switched on</li> <li>■ Indicates an internal system error.</li> </ul>
<p><b>2</b></p>	<p><b>Electricity supply heating external Transfer Line (optional)</b></p>	<p>Connection for an external heated Transfer Line (T4)</p> <p>This connector is optional.</p>

<p><b>3</b></p>	<p><b>Pushable Rotary Knob</b></p>	<p>Input control for cycling through and activating the control elements of the graphical user interface.</p>
<p><b>4</b></p>	<p><b>Sample In socket</b></p>	<p>3 mm Swagelok inlet plug with integrated Luer-port for connecting the device to a gas source via</p> <ul style="list-style-type: none"> <li>• Bypass Adapter</li> <li>• Transfer-line</li> <li>• Disposable syringes</li> </ul>
<div style="display: flex; align-items: center;">  <div> <p><b>DANGER</b></p> <p>The <b>Sample In socket</b> can reach higher temperatures (up to 50°C) approximately during the cleaning procedure. Do not touch these parts during the cleaning procedure.</p> </div> </div>		
<p><b>5</b></p>	<p><b>Touch screen Display</b></p>	<p>Displays the graphical user interface and allows the control of the device by touch screen.</p>
<p><b>6</b></p>	<p><b>USB Socket</b></p>	<p>USB socket for connecting external USB storage volumes. These volumes can be used for:</p> <ul style="list-style-type: none"> <li>• exporting measurement files</li> <li>• importing sample name lists</li> <li>• Import/Export programs</li> <li>• upgrading the device's firmware</li> <li>• saving/loading system settings.</li> </ul>
<p><b>7</b></p>	<p><b>Power LED</b></p>	<p>Indicates whether the device is connected to a power supply and is switched on</p>
<p><b>8</b></p>	<p><b>Fault LED</b></p>	<p>Indicates an internal system error.</p>

## 5.4.2 Rear

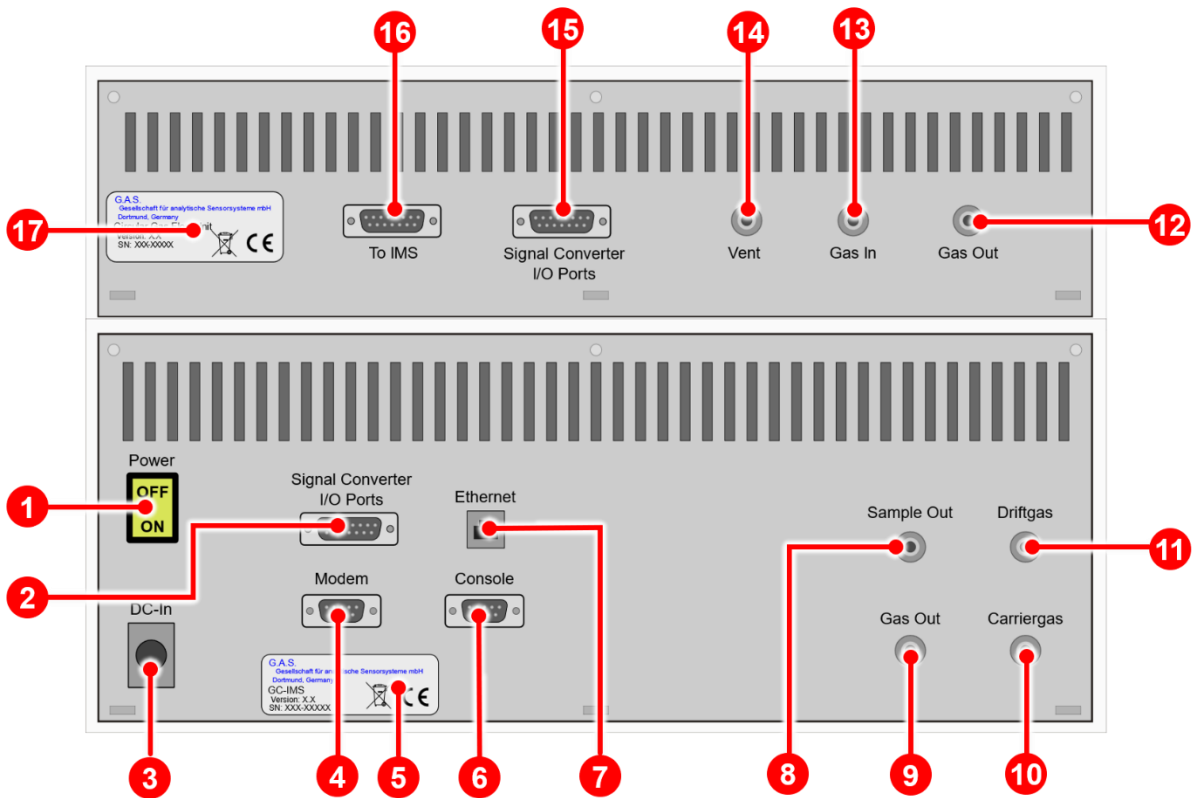

Figure 11: BreathSpec® (Version 5G1) - Housing of device - Rear

1	<b>Power Switch</b>	Switches the device on or off.
2	<b>Signal Converter –I/O Ports</b>	Socket for connecting a PLC (Programmable Logic Controller) or other devices.
3	<b>DC-In</b>	24 V XLR-Connector for connecting the power supply.
4	<b>Modem</b>	Socket for connecting an external modem. <b>For service purposes only.</b>
5	<b>Device Type/Serial Number Plate</b>	Displays manufacturer identification, device type, serial number and version.

6	Console	Console interface socket. <b>For service purposes only.</b>
7	Ethernet	Socket for connecting the device to a local area network (LAN) or directly to a computer.
8	Sample Out	3 mm Swagelok plug for connecting the device to an adequate laboratory waste gas ventilation system/fume hood.
9	Gas Out	3 mm Swagelok plug for connecting the device to the <b>Gas In Socket 13</b> of the CGFU
10	Carriergas	3 mm Swagelok inlet plug for connecting the device to <b>Gas Out Socket 12</b> of CGFU.
11	Driftgas	3 mm Swagelok inlet plug for connecting the device to <b>Gas Out Socket 12</b> of CGFU.
12	Gas Out	3 mm Swagelok plug for connecting the device to <b>Drift Gas In Socket / Carrier Gas In Socket 11 10</b> of BreathSpec®
13	Gas In	3 mm Swagelok plug for connecting the device to <b>Gas Out Socket 9</b> of BreathSpec®.
14	Vent	Socket for the internal pressure compensation.
15	Signal Converter –I/O Ports	Socket for connecting a PLC (Programmable Logic Controller) or other devices.

<b>16</b>	<b>To IMS</b>	Sub D Socket to power supply and device control of CGFU via BreathSpec®. The “ <b>To IMS</b> ” socket of the CGFU must be connected to the connector “ <b>Signal Converter I/O Ports</b> ” of the BreathSpec®.
<b>17</b>	<b>Device Type/Serial Number Plate</b>	Displays manufacturer identification, device type, serial number and version.

## 5.5 BreathSpec® Housing Device with Airsense $\mu$ TD

### 5.5.1 Top

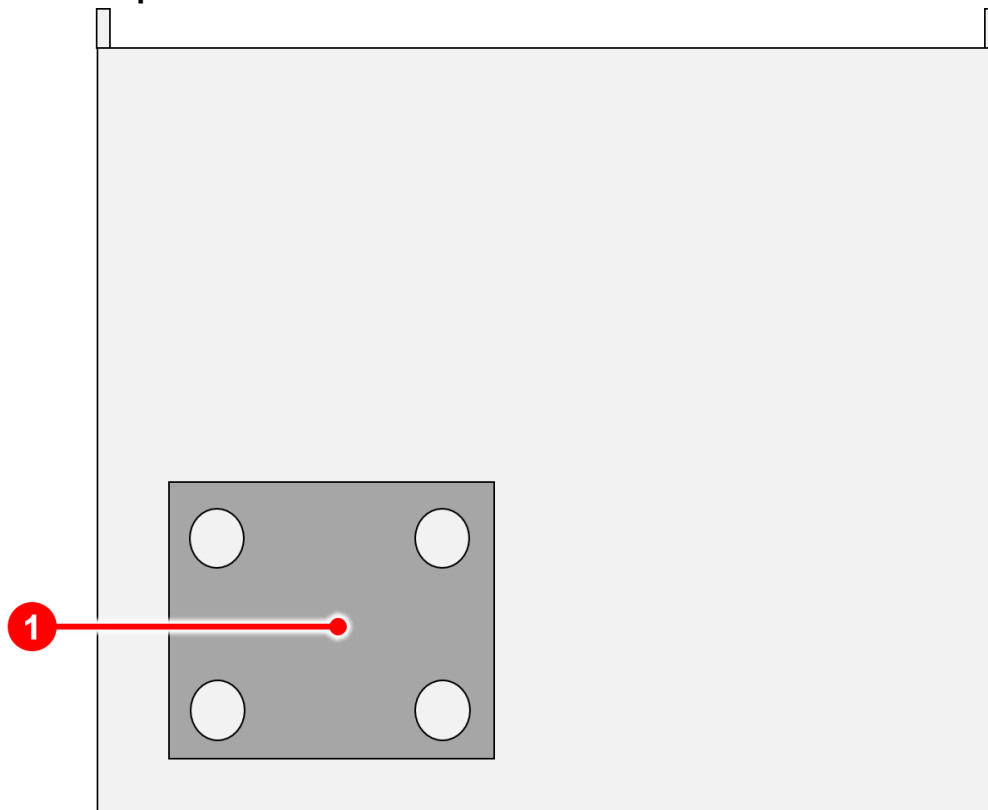

Figure 12: BreathSpec® with Airsense  $\mu$ TD (Version 5G2) - Housing of device - Top

<b>1</b>	<b><math>\mu</math>TD Mounting Plate</b>	<ul style="list-style-type: none"><li>• Mounting plate for placing the <math>\mu</math>TD Unit</li></ul>
----------	--	--

5.5.2 Front

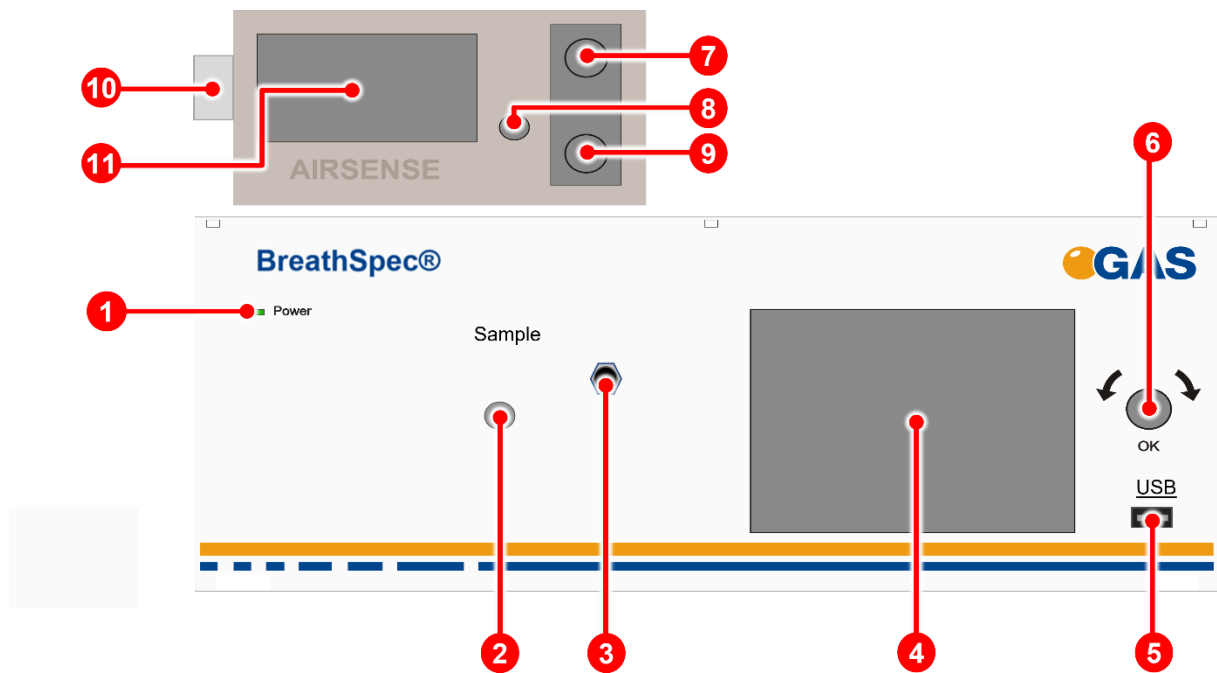

Figure 13: BreathSpec® (Version 5G2) with Airsense  $\mu$ TD - Housing of device - Front

<p><b>1</b></p>	<p><b>Power LED</b></p>	<ul style="list-style-type: none"> <li>■ Indicates whether or not the device is connected to a power supply and is switched on</li> <li>■ Indicates an internal system error.</li> </ul>
<p><b>2</b></p>	<p><b>Sample In socket</b></p>	<p>3 mm Swagelok inlet plug with integrated Luer-port for connecting the device to a gas source via</p> <ul style="list-style-type: none"> <li>Bypass Adapter</li> <li>Transfer-line</li> <li>Disposable syringes</li> </ul>
<p><b>DANGER</b></p> <p>The <b>Sample In socket</b> can reach higher temperatures (up to 50°C) approximately during the cleaning procedure. Do not touch these parts during the cleaning procedure.</p>		
<p><b>3</b></p>	<p><b>Electricity supply heating external Transfer Line</b></p>	<p>Connection for an external heated Transfer Line (T4)</p>

	<b>(optional)</b>	This connector is optional.
<b>4</b>	<b>Touch screen Display</b>	Displays the graphical user interface and allows the control of the device by touch screen.
<b>5</b>	<b>USB Socket</b>	<p>USB socket for connecting external USB storage volumes. These volumes can be used for:</p> <ul style="list-style-type: none"> <li>• exporting measurement files</li> <li>• importing sample name lists</li> <li>• Import/Export programs</li> <li>• upgrading the device's firmware</li> <li>• saving/loading system settings.</li> </ul>
<b>6</b>	<b>Pushable Rotary Knob</b>	Input control for cycling through and activating the control elements of the graphical user interface.
<b>7</b>	<b>Inlet Sampler Connector</b>	Heated Transfer Line for connection to a sample source
<b>8</b>	<b>Start/Stop Button</b>	Switches the $\mu$ TD device on or off.
<b>9</b>	<b>Inlet Detector Connector</b>	Heated Transfer Line for connection to GC-IMS sample in connector
<b>10</b>	<b>Adsorbens Tube Holder</b>	The adsorbens tube can be installed.
<b>11</b>	<b>Display</b>	Displays the current phase of the desorption cycle

5.5.3 Rear

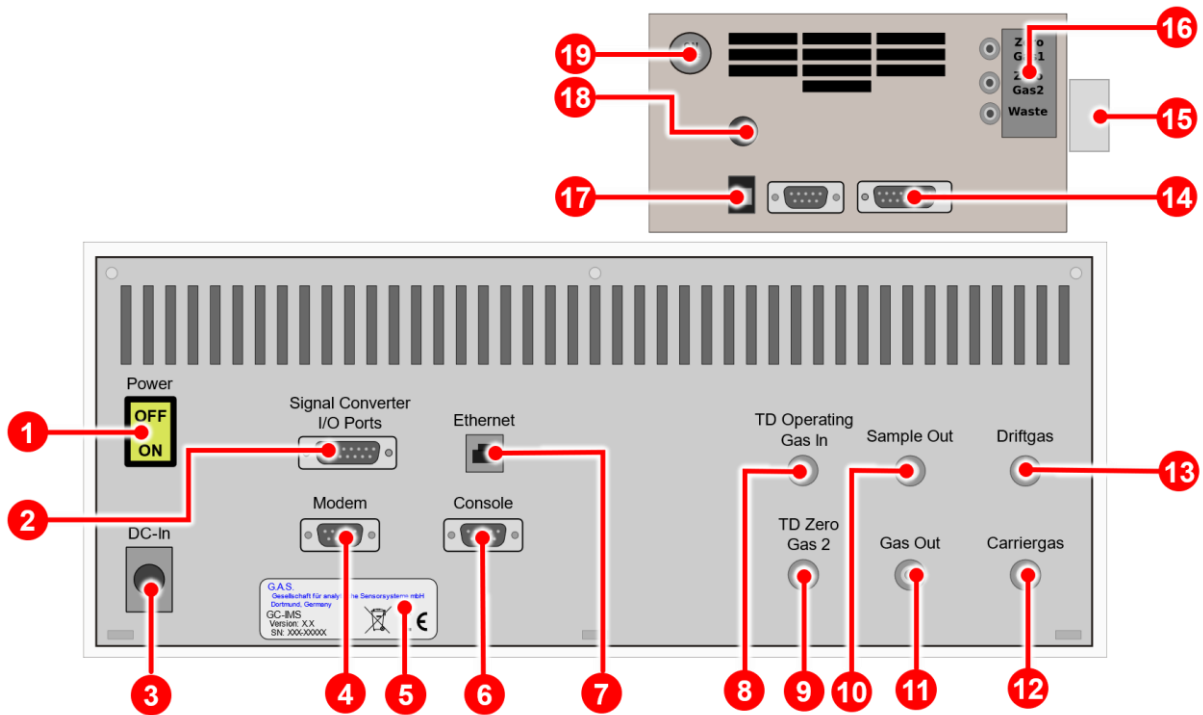

Figure 14: BreathSpec® (Version 5G2) with Airsense µTD - Housing of device - Rear

1	<b>Power Switch</b>	Switches the device on or off.
2	<b>Signal Converter –I/O Socket</b>	Socket for connecting a PLC (Programmable Logic Controller) or other devices.
3	<b>DC-In Socket</b>	24V XLR-Connector for connecting the power supply.
4	<b>Modem Socket</b>	Socket for connecting an external modem. <b>For service purposes only.</b>
5	<b>Device Type/Serial Number Plate</b>	Displays manufacturer identification, device type, serial number and version.
6	<b>Console Socket</b>	Console interface socket. <b>For service purposes only.</b>

7	Ethernet Socket	Socket for connecting the device to a local area network (LAN) or directly to a computer.
8	TD Operation Gas In	3 mm Swagelok inlet plug for connecting the device to an operating gas source.
9	TD Zero Gas 2	3 mm Swagelok inlet plug for connecting the device to the 3 mm Zero Gas 2 connector of the $\mu$ TD.
10	Sample Out Socket	3 mm Swagelok plug for connecting the device to an adequate laboratory waste gas ventilation system/fume hood.
11	Gas Out Socket	3 mm Swagelok plug for connecting the device to an adequate laboratory waste gas ventilation system/fume hood.
12	Carrier Gas In Socket	3 mm Swagelok inlet plug for connecting the device to a drift gas source.
13	Drift Gas In Socket	3 mm Swagelok inlet plug for connecting the device to a drift gas source.
14	Digital Port	Digital Port to connect the $\mu$ TD to the GC-IMS Signal Converter I/O Port with interface cable.
15	Tube Holder	Tube holder for adsorption tube
16	Gas connectors	3 mm Gas port <b>Zero Gas1</b> , <b>Zero Gas2</b> and <b>Waste</b>
17	USB Socket	Socket for connecting the device to a computer.

<b>18</b>	<b>Power Supply Socket</b>	Connector for connecting the $\mu$ TD power supply
<b>19</b>	<b>Power Switch</b>	Switches the device on or off.

### 5.6 Device Type / Serial Number Plate

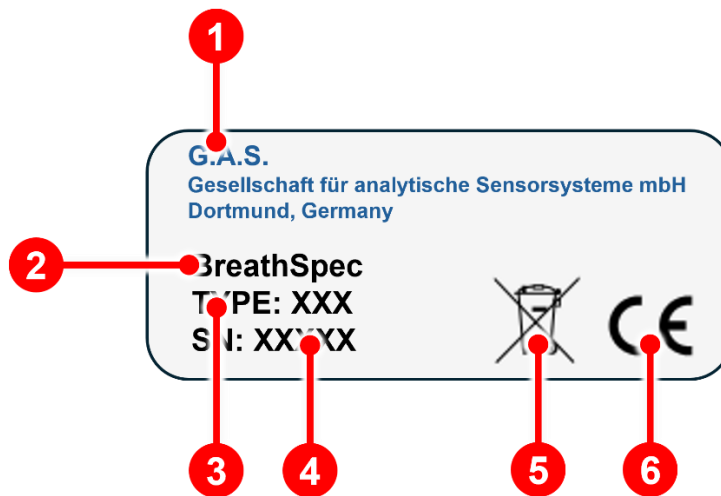

Figure 15: Device Type / Serial Number Plate

<b>1</b>	<b>Manufacturer</b>
<b>2</b>	<b>Type Name</b>
<b>3</b>	<b>Version Number</b>
<b>4</b>	<b>Serial Number</b>
<b>5</b>	<b>Disposal Instructions</b> This marking on the instrument indicates that they must not be disposed of in domestic waste. The disposal is carried out by return to the manufacturer or by the corresponding municipal authorities (see EU directive 2012/19/EU)

6

### CE Marking

#### CE, Communauté Européenne

Instruments bearing this mark comply with the relevant European directives

## 6 Operating Interface

The graphical user interface of the device can be controlled by using the touchscreen in combination with the pushable rotary knob at the front of the device.

The selected control (button, input field etc.) element is marked blue. To activate it the knob can be pressed.



### INFORMATION!

As the product is under continuously development, the screen shots in this user manual may differ from the actual conditions.

All possible functionalities of the firmware are described.

Depending on the hardware some functionalities are not available.

## 6.1 Overview

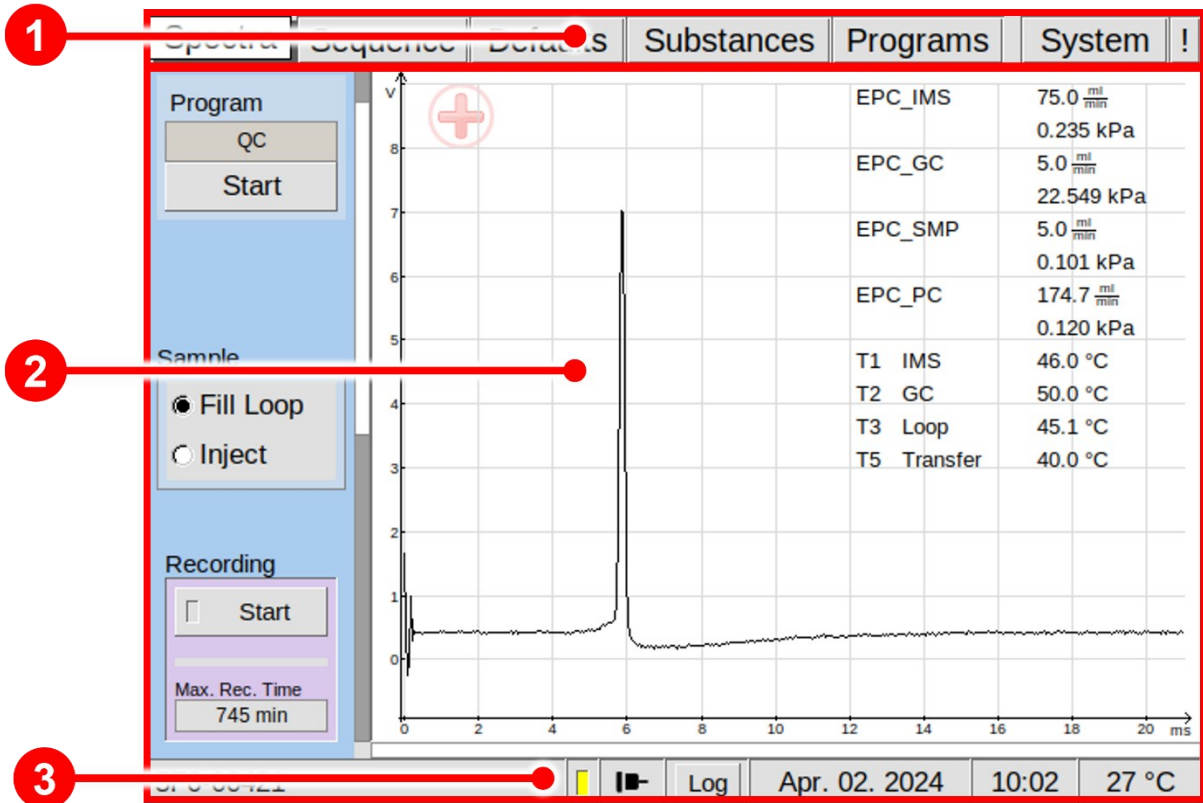

Figure 16: Operating Interface - Overview

<b>1</b>	<b>Window Selection Bar</b>	The main windows can be selected.
<b>2</b>	<b>Window Display Area</b>	The content of the selected main window will be displayed.
<b>3</b>	<b>Status Bar</b>	Status messages and system information are displayed.

6.1.1 Windows Selection Bar

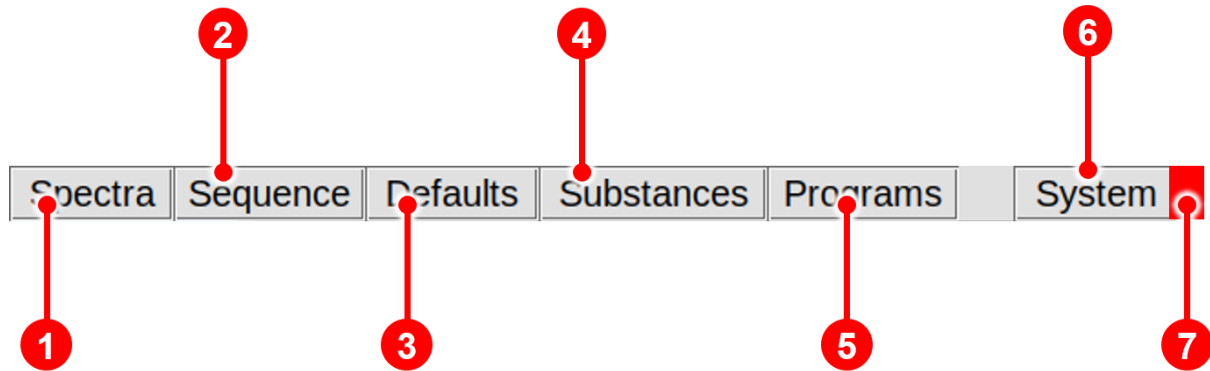

Figure 17: Operating Interface - Windows Selection Bar

<b>1</b>	<b>Spectra Window Button</b>	In Spectra Window the data acquisition process is controlled.
<b>2</b>	<b>Sequence Window Button</b>	In Sequence Window user created sequence files using the Sequence Designer software can be imported.
<b>3</b>	<b>Defaults Window Button</b>	In Defaults Window the default settings can be set.
<b>4</b>	<b>Substances Window</b>	In Substances Window a Substance list with assign search parameter sets can be managed.
<b>5</b>	<b>Programs Window Button</b>	In Programs Window user-defined measurement programs can be set.
<b>6</b>	<b>System Window Button</b>	In System Window system specific information are displayed system specific settings and can be set.
<b>7</b>	<b>Errors Information Window Tab</b>	In Error Information Window current error information are displayed.

### 6.1.2 Windows Display Area

In Window Display Area the content of the following main windows is displayed:

- Spectra Window
- Sequence Window
- Defaults Window
- Substances Window
- Programs Window
- System Window

### 6.1.3 Status Bar

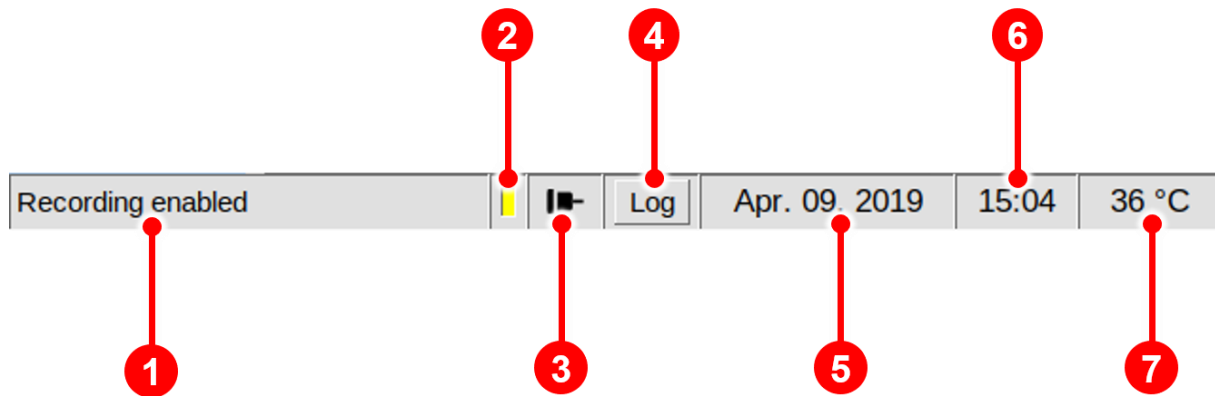







Figure 18: Operating Interface - Status Bar

1	<b>Status Message Section</b>	Device events information will be displayed.
2	<b>Export Message Section</b>	Displays the current connection status. Export on:  Export of 
3	<b>LAN Connection Section</b>	Displays the current connection status: Connected:  Disconnected: 
4	<b>Log Section</b>	Displays the current log status. New entry:  No modification:  Selecting this button will open the Log Section Window with a chronological list of system events

<b>5</b>	<b>Date Section</b>	Displays the current date of the device clock. It can be set in System Window.
<b>6</b>	<b>Time Section</b>	Displays the current time of the device clock. It can be set in System Window.
<b>7</b>	<b>Temperature Section</b>	Displays the current inner housing temperature of the device.

### 6.1.4 View Control Bar

The view control bar function is available in the Spectra window and in the Defaults window. By touching the screen, the control bar is displayed underneath the displayed spectra.

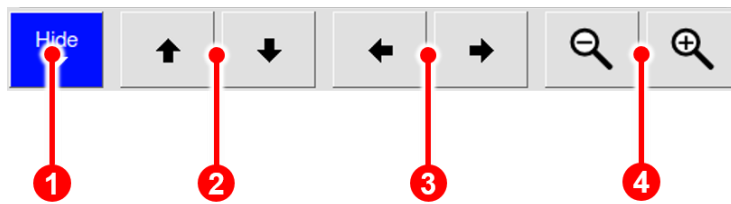

Figure 19: Operating Interface – View Control Bar

<b>1</b>	<b>Hide Button</b>	The control bar can be hidden manually. After 3 seconds of inactivity it is hidden automatically.
<b>2</b>	<b>Vertical Control Buttons</b>	Moves the vertical position of the display area on the screen up or down.
<b>3</b>	<b>Horizontal Control buttons</b>	Moves the horizontal position of the display area on the screen left or right.
<b>4</b>	<b>Zoom Control buttons</b>	Reduces or enlarges the view of the display area on the screen

## 6.1.5 Low/High Pressure Control

The device pressure is monitored. Two types of error are defined:

### 6.1.5.1 Low Pressure Error

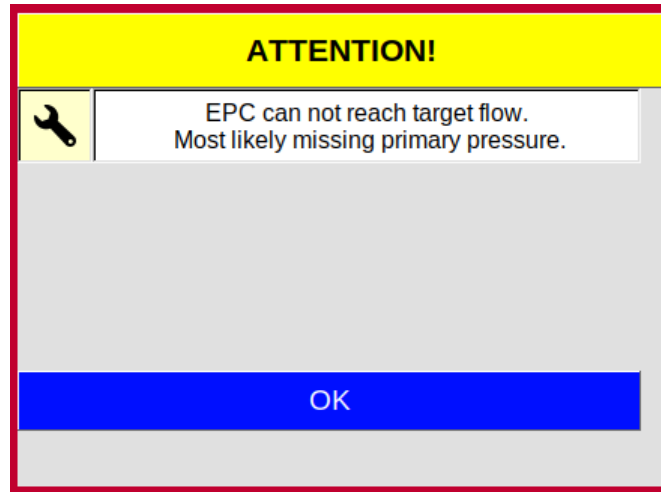

Figure 20: Operating Interface - Low Pressure Alarm Box

1. After 10 seconds a dialogue box is displayed and an acoustic alarm sounds.
2. After 5 minutes all temperature controllers are switched off.
3. When the pressure is reached again the alarm is switched off and all temperature controllers switch themselves on automatically

## 6.1.5.2 High Pressure Error



### **WARNING!**

High pressure can destroy the device.

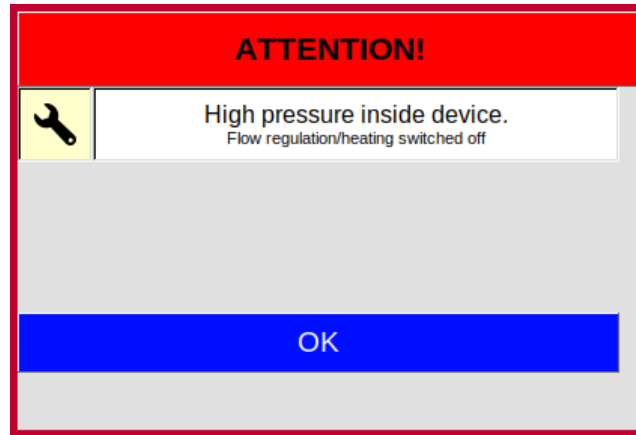

*Figure 21: Operating Interface - High Pressure Alarm Box*

1. If overpressure is detected, a visual and audible alarm is triggered immediately. At the same time all temperature controllers and flow controllers are switched off.
2. Before continuing to operate the unit, the cause of the spotlight must be eliminated.
3. By confirming the dialogue box or restarting the system, all temperatures and flows are reset to their normal values.

## 6.2 Spectra Window

### 6.2.1 Overview

After the device is switched on and the system start is completed the Spectra Window is displayed. In the Spectra Window the data acquisition can be controlled.

The current spectrum is displayed. The Recording Mode can be activated. The selected measurement program can be started.

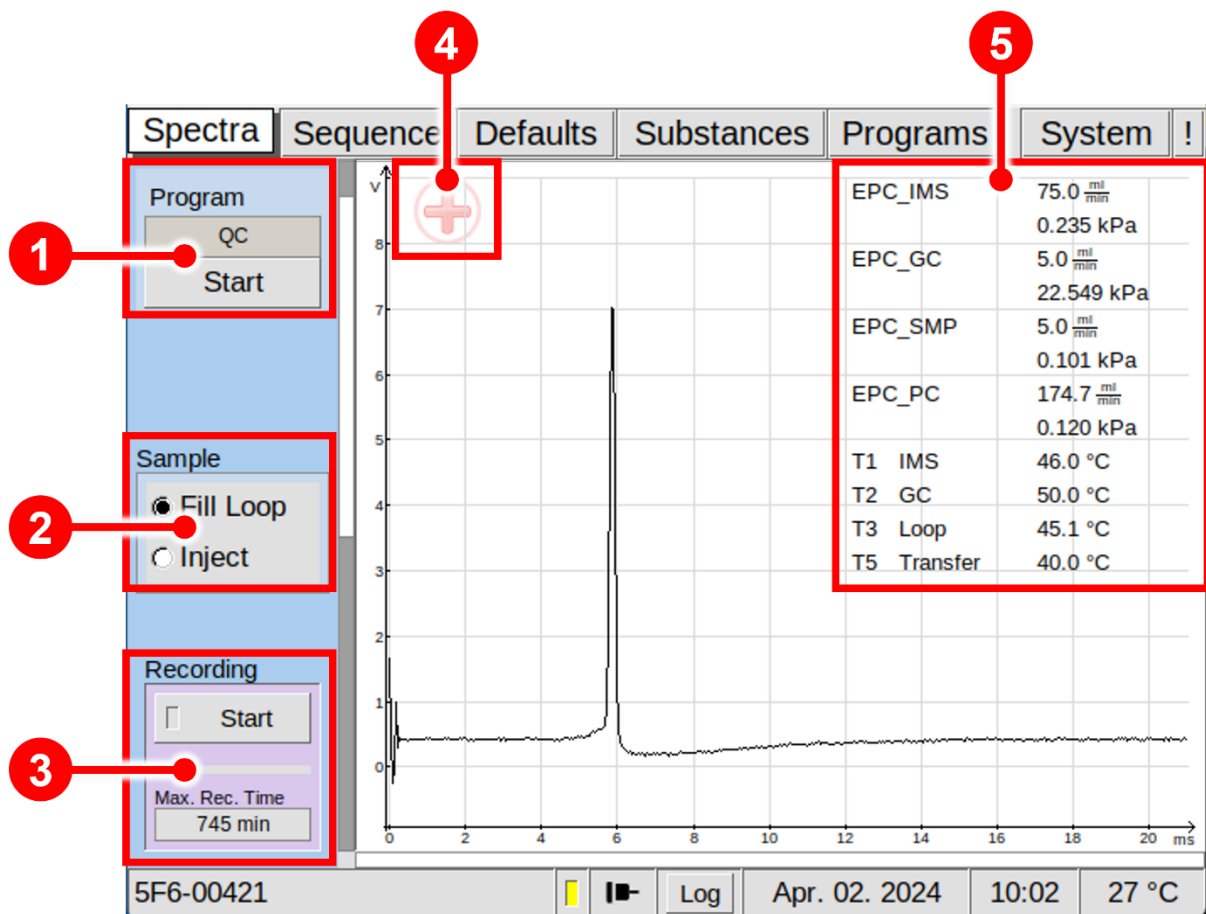

Figure 22: Operating Interface - Spectra Window

<b>1</b>	<b>Program Start Button</b>	By selecting this button the displayed program is started.
<b>2</b>	<b>Switching Valve Button</b>	The 6-port-valve can be toggled manually between <b>Fill Loop</b> and <b>Inject Position</b> . The <b>basic setting</b> must be set to <b>Fill Loop</b> .

<b>3</b>	<b>Recording Check Box</b>	The live monitoring of measurements can be recorded manually. The available storage capacity in minutes is displayed.
<b>4</b>	<b>Drift Voltage Mode</b>	Displays the current selected Drift Voltage state (positive / negative).
<b>5</b>	<b>Device Parameter</b>	Displays the current temperature, flow and pressure values.

### 6.2.2 Measurement modes

Two measurement modes are available:

- Measurement with user defined programs
- Manually operated measurement

#### 6.2.2.1 Measurement with user defined programs

In this mode data acquisition with user-defined measurement programs can be started. The executable measurement program can be created and selected in the Programs Window. The name of the current selected program is displayed in the upper left of the Spectra Window. The selected measurement program can be started by activating the Program button in the upper left of the Spectra Window.

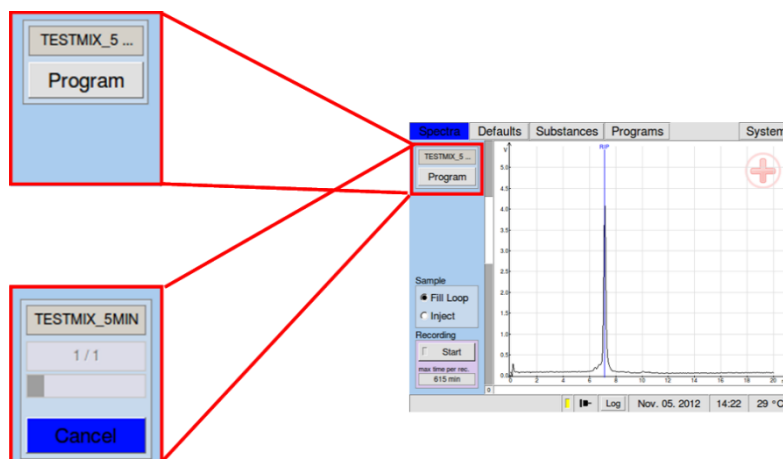

Figure 23: Start Program

### 6.2.2.2 Manually operated measurement

To record a measurement manually the Recording button can be switched on. If recording is not active the button is set to **START** and the checkbox is grey. If recording is active the button is set to **STOP** and the checkbox is yellow.

In this case a measurement file is generated from the recorded data and saved to the internal flashcard. The remaining time for data storage to the internal flashcard is shown. It depends on the number of measurement data that were released for export but were not yet exported and their file size depends on the value of spectra averages that are used.

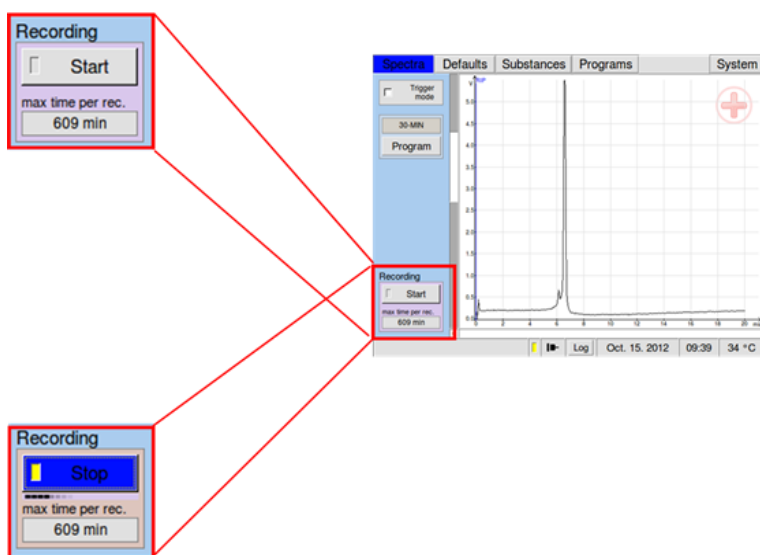

Figure 24: Recording Check Box

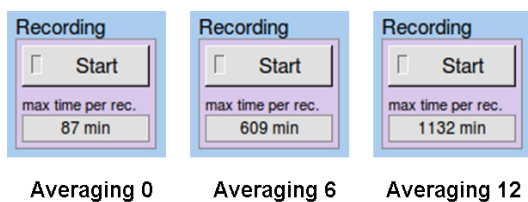

Figure 25: Recording Check Box

### 6.3 Sequence Window

In **Sequence** Window sequence files can be imported and started by clicking on the **Start** Button. The processing status of a user created sequence file can be watched:

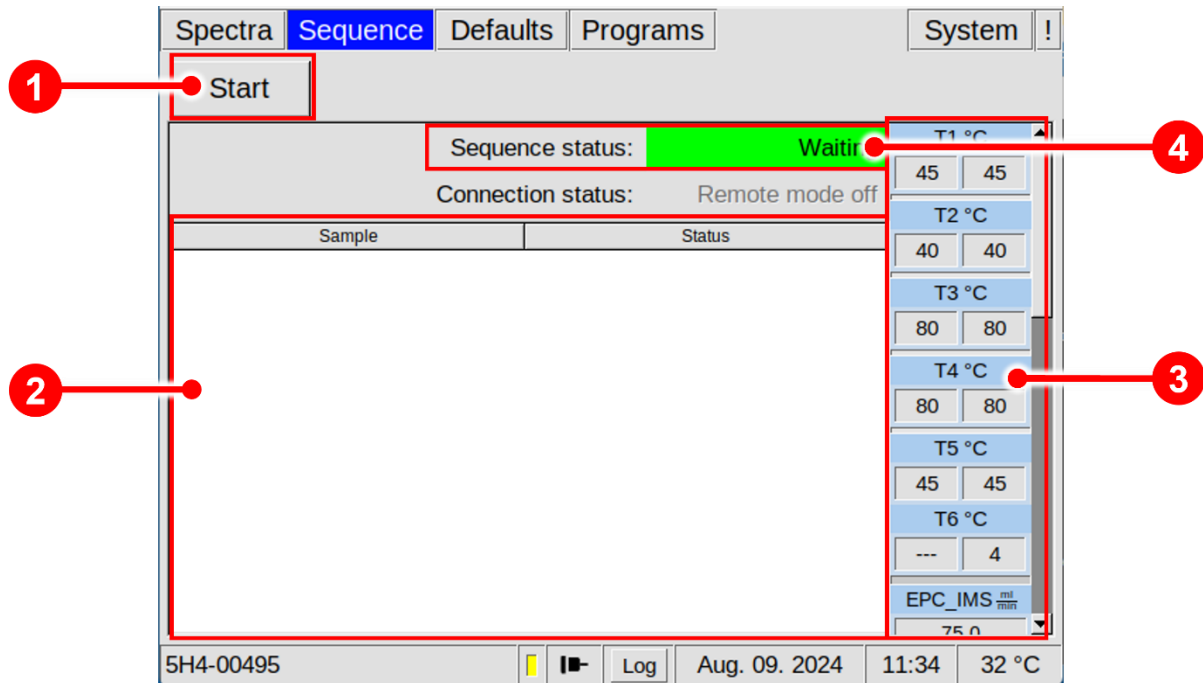

Figure 26: Operating Interface - Sequence Window

<b>1</b>	<b>Start Button</b>	A user created sequence files, created by <b>G.A.S. Sequence Designer Software</b> , can be imported.
<b>2</b>	<b>Information Window</b>	Displays the imported sequence-list. The actual status of each sample is shown.
<b>3</b>	<b>Device Parameter</b>	Displays the current temperature, flow and pressure values.
<b>4</b>	<b>Sequence status</b>	Displays the current sequence status:  Possible values are: <ul style="list-style-type: none"> <li>- Waiting</li> <li>- Running</li> <li>- Finished/waiting</li> </ul>

**INFORMATION!**

If the tftp-protocol is used for data transmission, the sequence file must be named as **sequence.json**.

After selection, the software will try to import and analyse the sequence file. If the file could be imported and the analysis showed no errors, the sequence will be executed. The following figure shows the execution of a sequence:

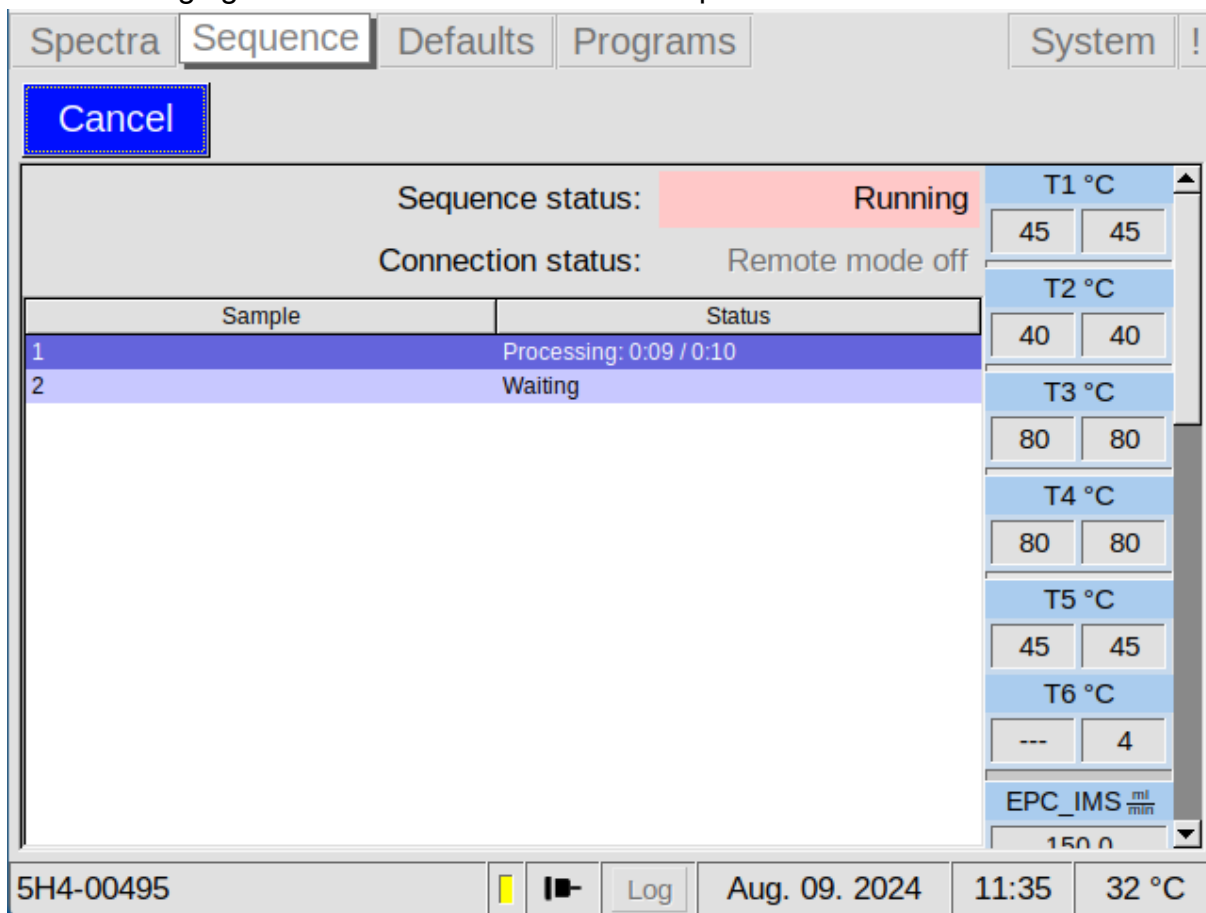

Figure 27: Operating Interface - Sequence Window - Processing

You will see the sequence being processed, one sample after the other. The time passed and the total time for each sample are displayed, showing you the progress. The scrollable area on the right displays the current and the target device parameters for temperatures and flows, as well as some IMS specific values such as voltages and the trigger duration. Clicking on the **Cancel** button will stop the **Sequence**, but still apply all the **After Run Settings**. Once the **Sequence** has finished, all samples will be marked as done, the last **After Run Settings** are applied and the software will display the message Execution finished. The system is now ready for further sequences or manual operation.



**INFORMATION!**  
The sequence file must be created with the **G.A.S. Sequence Designer Software**. For detailed Information refer to the **G.A.S. Sequence Designer Software Manual**.



**INFORMATION!**  
From firmware version 4.50, the use of the sequence designer version 1.5 or higher is mandatory.

## 6.4 Defaults Window

### 6.4.1 Overview

The Defaults window allows the monitoring and modification of various device component parameters. The electronic pressure controllers (EPC\_IMS and EPC\_GC) and the heated device components of the device can be controlled (T1 – T6). Further, the sample pump duty, averaging and drift voltage polarity can be switched manually.

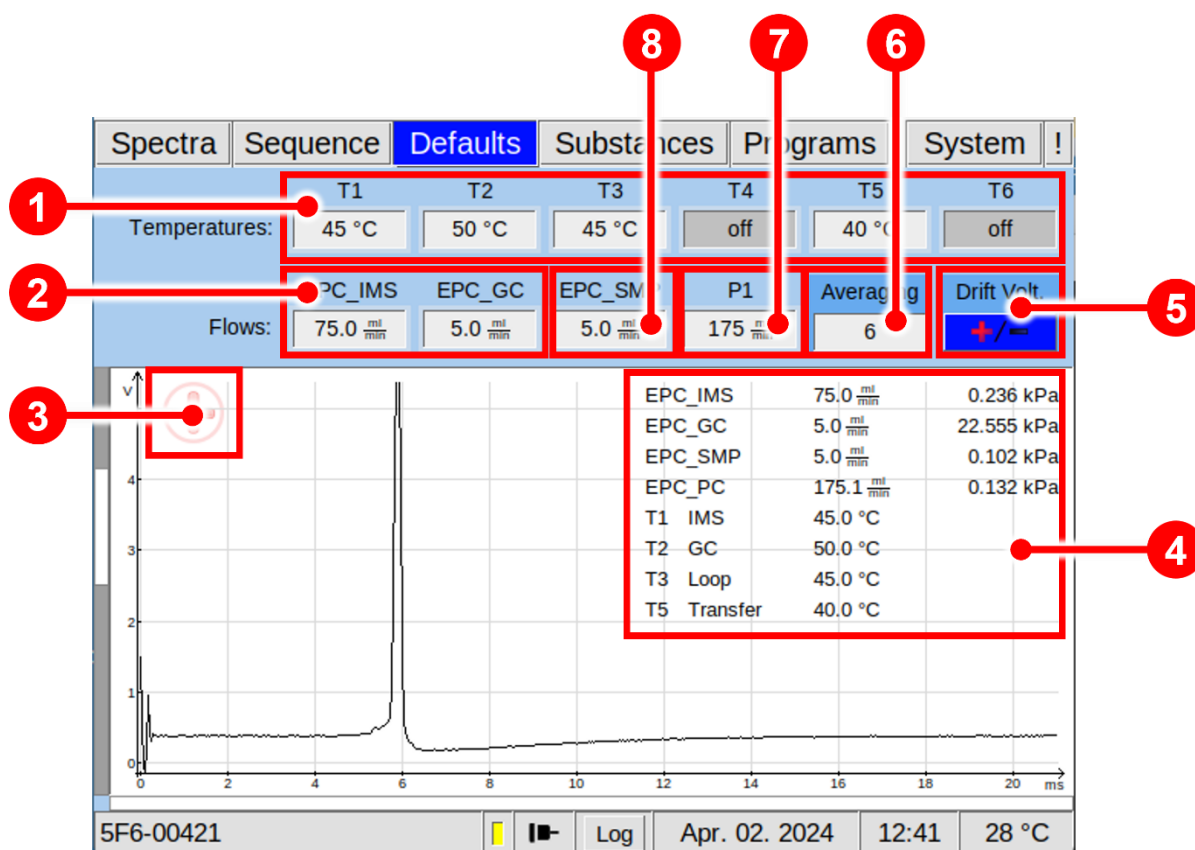

Figure 28: Operating Interface - Defaults Window

<p><b>1</b></p>	<p><b>Temperature display</b></p>	<p>The temperature values of the heated device components <b>IMS (T1)</b>, <b>GC (T2)</b>, <b>Loop (T3)</b>, <b>internal Transfer Line (T5)</b> and <b>optional external Transfer Line (T4)</b> can be set. The current Temperatures (T1–T5) are displayed. Temperature module T6 is currently not available. The maximum value is 80°C.</p>
<p><b>2</b></p>	<p><b>Flow display</b></p>	<p>The flowrate of Drift gas <b>(EPC_IMS)</b> and Carrier gas <b>(EPC_GC)</b> can be set.</p>

		The current flowrates for Drift gas (EPC_IMS) and Carrier gas (EPC_GC) are displayed. The maximum value for EPC_IMS is 500 ml/min. The working value for EPC_IMS depends on the application. The recommended working value for EPC_IMS is 75 ml/min. The working value of EPC_GC depends on the application and is influenced by the built-in GC-Column (length, inner diameter).
3	<b>Drift Voltage mode</b>	Displays the current selected Drift Voltage state (positive / negative).
4	<b>Device Parameter</b>	Displays the current temperature, flow and pressure values.
5	<b>Drift-Voltage Button</b>	<b>Drift Voltage</b> polarity can be selected and switched (positive/negative).
6	<b>Averaging display</b>	Displays the current <b>Averaging</b> value. The averaging value determines how many raw spectra are averaged to generate one single spectrum as result in the stored measurement file. Modifying the averaging parameter affects the number of recorded spectra per time interval. A typical averaging value is 6. The maximum is set to 99. A value of 0 (Off) disables averaging.
7	<b>Sample Pump (P1)</b>	The Sample In flow in ml/min of the sample pump duty can be set in <b>P1</b> . The working value depends on the application. The minimum and maximum values are determined by the pump control.
8	<b>µTD Flow (EPC_SMP) (Optional)</b>	<b>This Field is only available if the system is prepared for use with a µTD.</b> The µTD gas supply-flowrate (EPC_SMP) can be set. EPC_SMP stands for EPC Sample_control

The maximum value for EPC\_SMP is 150 ml/min. The working value for EPC\_SMP depends on the application, typically it is 10 ml/min.



**INFORMATION!**

For more detailed information on handling the  $\mu$ TD refer to the [μTD-Tutorials](#).

## 6.4.2 Drift Voltage

The Drift Voltage can be switched between positive and negative drift voltage mode. One of these two modes may be more suitable for specific substances.

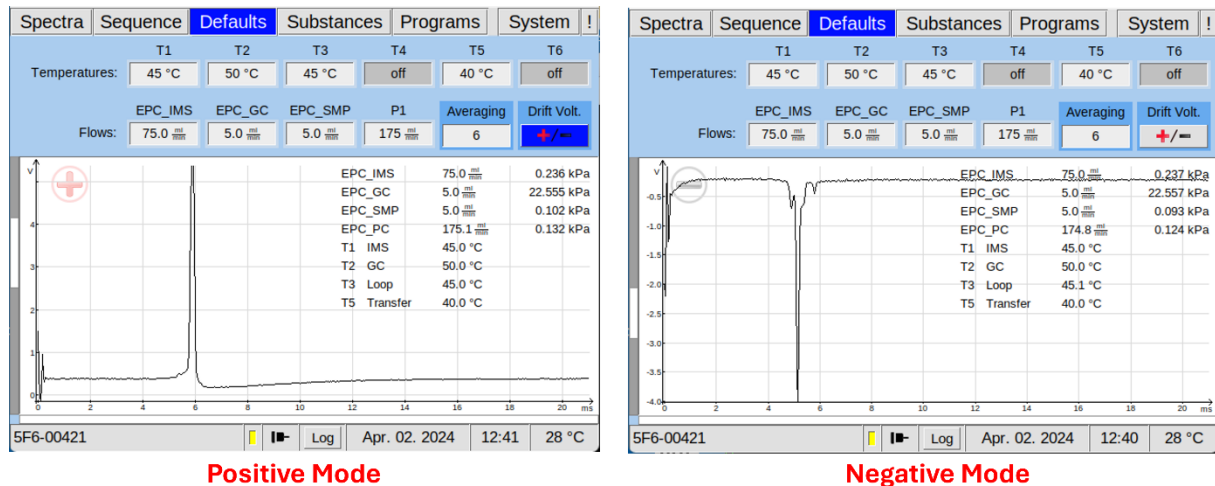

Figure 29: Drift Voltage Windows - positive and negative Mode

## 6.4.3 Flow Controls Setpoints

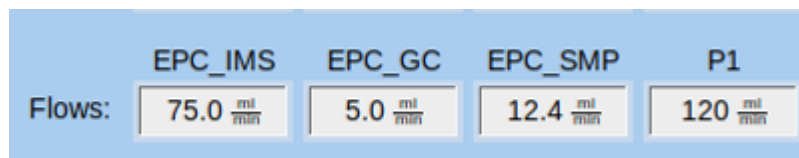

Figure 30: Flow Control (Example)

The flow parameters can be modified in the **Flows** section of the window. The flow rates of the drift and carrier gas controlled by the two electric pressure controllers (EPC\_IMS and EPC\_GC). The maximum value for EPC\_IMS is 500 ml/min. The maximum value for EPC\_GC is 150 ml/min (Depending on the column used). If available, the uTD Flow (EPC\_SMP) can be set. Recommended flow is 10 ml/min. The sample flow can be set within the minimum and maximum values of the pump control.

## 6.4.4 Temperatures Control Setpoints

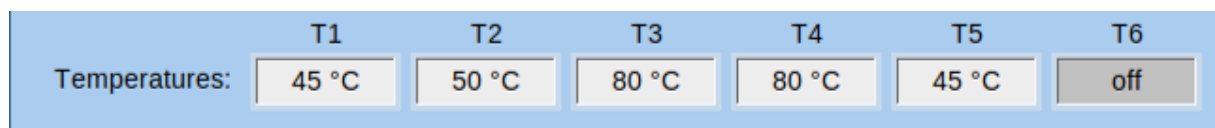

Figure 31: Temperatures Control (Example)

The temperature parameters of the heated device components can be modified in the Temperatures section of the window. Unused elements are greyed out. The set points of the IMS (T1), the GC column (T2), the Sample Loop (T3) and the inner heated Transfer Lines (T4 and T5) are displayed. The set points can be set using these controllers. The maximum adjustable temperature value is 80°C. During the cleaning process the heated device components can reach temperatures up to 100°C. These will be displayed as “> 80°C”. The heating of the device components can be turned off by decreasing the respective value to 0, which will be displayed as “off”.

## 6.5 Substances Window

### 6.5.1 Overview

In the Substances window a list of **up to 50 substances** with defined search parameter sets can be managed. This substance list is used for analysing the measurement data during a measurement program run. The result of this analysis is a subset of the substances in this list detected in the respective gas sample. It is stored along with the measurement data.

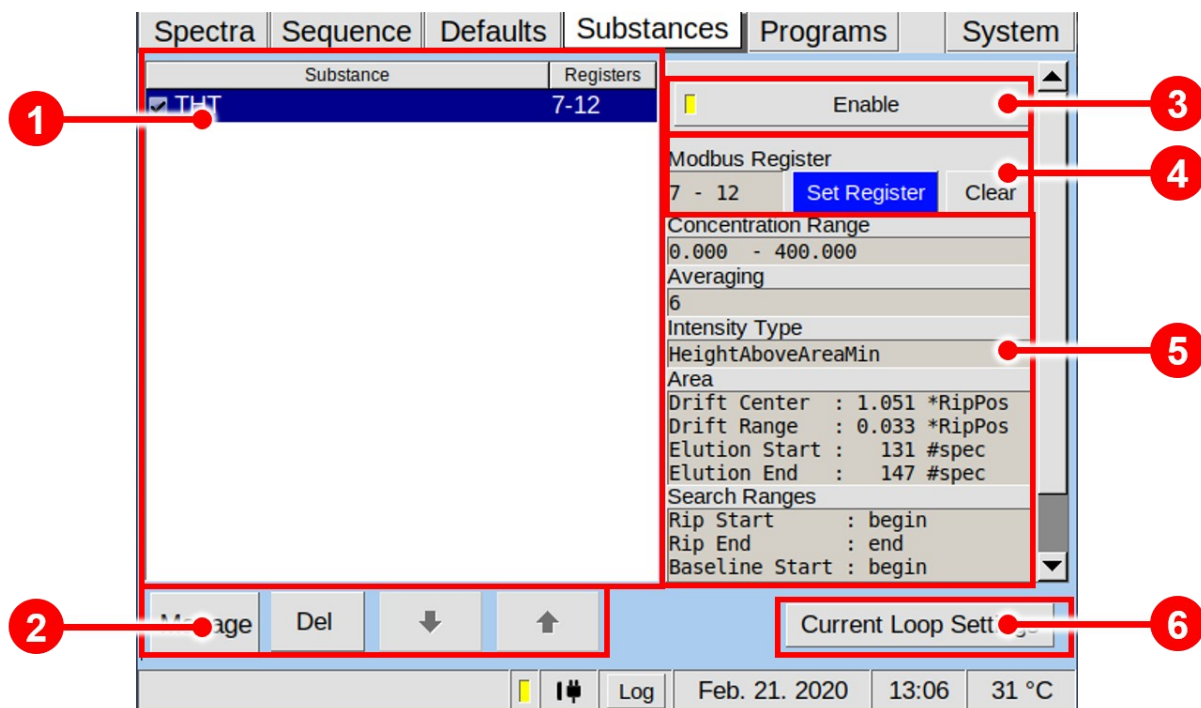





Figure 32: Operating Interface - Substances Window

1	<b>Substances List window</b>	All created substance entries are listed in this box by name. The highlighted substance is selected for modification.
2	<b>Substances List Control Panel</b>	Buttons for Manage, changing or deleting actions of the selected substances 
3	<b>Enable Button</b>	Enables or disables the selected substance as a candidate for the detection process.
4	<b>Modbus Register</b>	 opens the Modbus Register setup dialog.  deletes set registers
5	<b>Substance Calibration Information Area</b>	Displays the substance specific calibration information such as used concentration range, average, intensity type, area, search ranges and the quantification model name.
6	<b>Current Loop Settings</b>	Opens the current loop setup dialog.

### 6.5.2 Managing Substance Entries



Figure 33: Substance List Control panel

The Substance List Control Buttons Panel contains buttons for importing Manage and deleting Del substance entries. By pressing the buttons Up ↑ and Down ↓ the position of a selected entry in the substances list can be changed.

By pressing the Manage button, the following selection window appears.

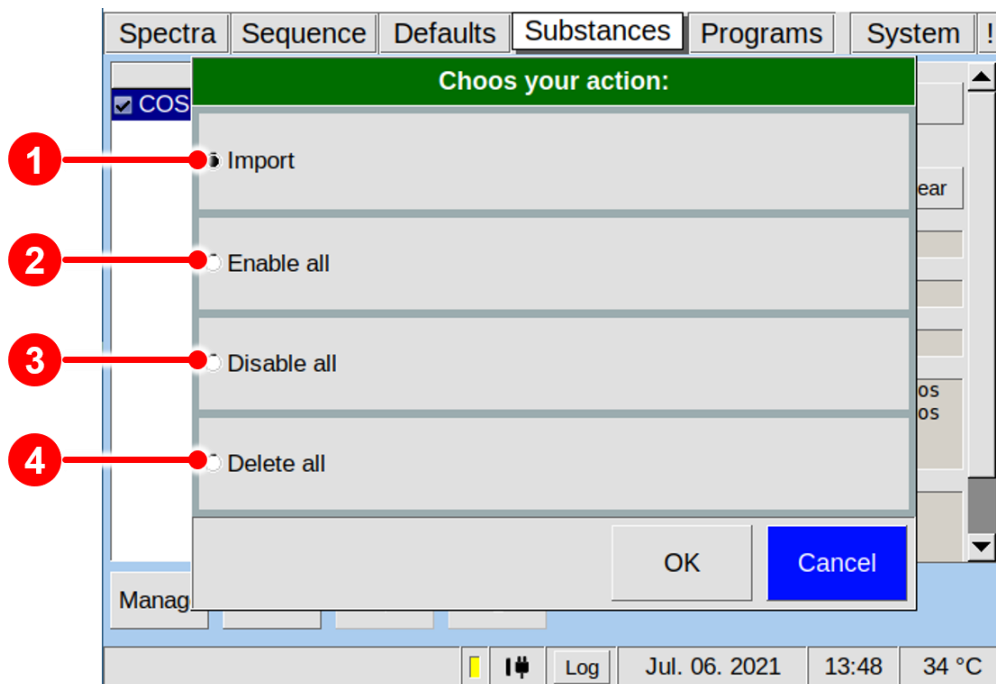

Figure 34: Substance List Control panel

<b>1</b>	<b>Import</b>	Import substance calibration files
<b>2</b>	<b>Enable all</b>	Enable all imported substances calibration files.
<b>3</b>	<b>Disable all</b>	Disable all imported substances calibration files.
<b>4</b>	<b>Delete all</b>	Delete all imported substances calibration files.

After importing a substance calibration file, it is available in the Substances List window.

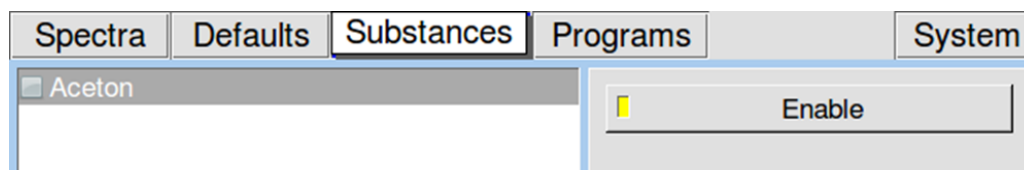

Figure 35: Substance selection 1

To make a substance active it must be activated by pressing the Enable Button. The activated substance is marked.

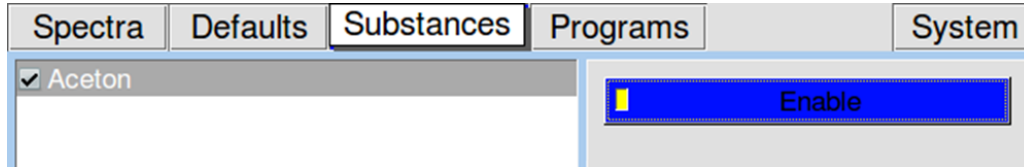

Figure 36: Substance selection 2

In case that the Averaging set in the selected Program and Substances data is different the relevant substance entry is shown in red and marked with an error symbol.

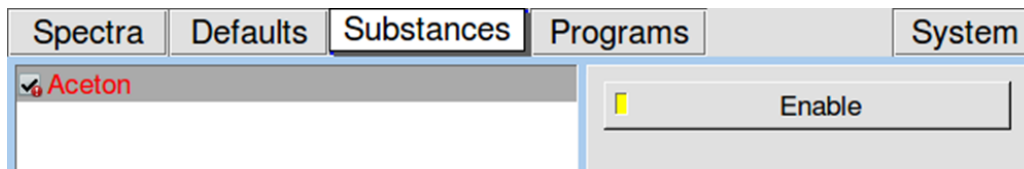
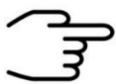

Figure 37: Substance selection 3

When the Enable Button for the selected substance is checked that substance entry will be included in the substance recognition process during the next measurement program run.



### INFORMATION!

For detailed Information about the compilation of Substance calibration files (gsd-files) refer to the [VOCAL Tutorials](#).

### 6.5.3 Managing Modbus TCP Setup

GAS Devices can output their results via the **Modbus TCP protocol**. The Registers can be set up on your device's Substances page. When selecting a substance from list on the left, information about it will be displayed on the right. This includes the registers it will be mapped to. Every substance will require a fixed set of registers, so the total of number substance information which can be transferred over the Modbus is limited. Registers for different substances cannot overlap. In case you try to overlap them, you will be informed by an error window, about which registers in specific have been assigned twice. Using the Enable button, you can select or deselect substances for evaluation. Deselecting them will result in the designated status code in the corresponding registers. You can check the last Modbus TCP connection to your device in **System > Transfer > Modbus TCP**. It will give you information on when and from which IP the last connection was made and whether it is still active (Figure 35).

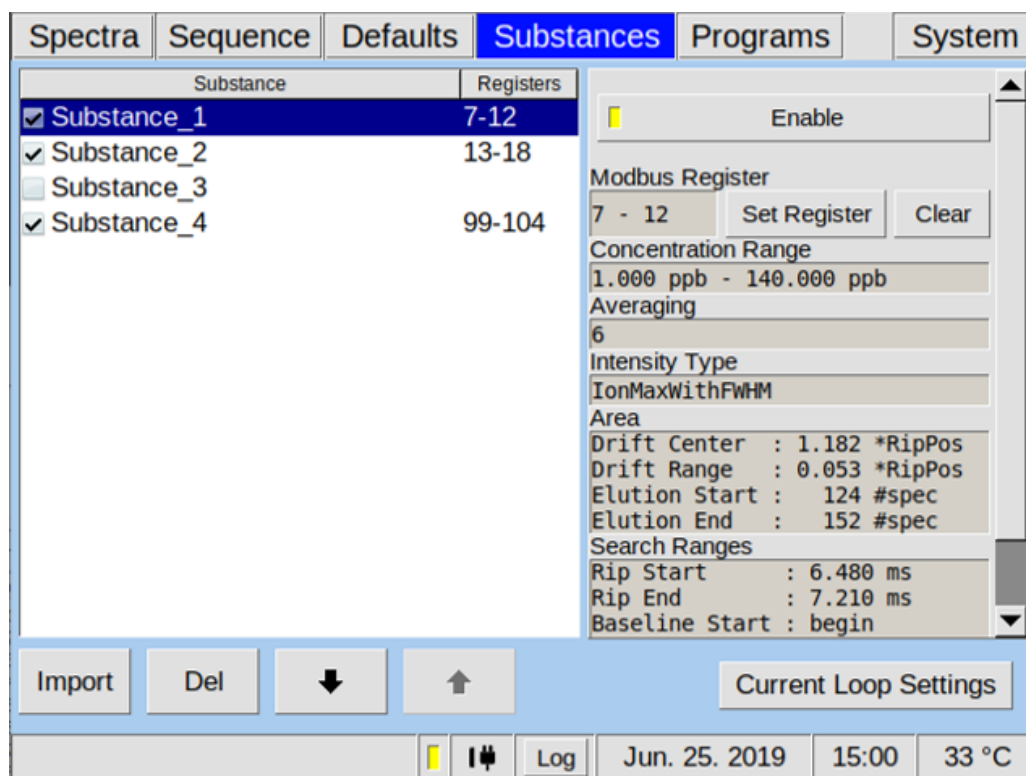

Figure 38: Substances Window

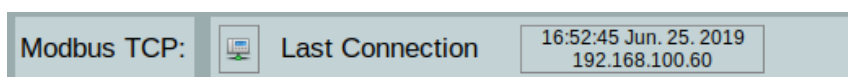

Figure 39: Information about the last Modbus TCP Connection

The results are put into the holding registers (40001-40250 function code FC03). These **250 registers** are **divided** into **two 125 register** long arrays which contain the current results in the first 125 and the results from before that in the latter 125

registers. At the beginning of each of these register blocks is the information header, which is 6 registers in size. See Chapter [9.6 Modbus TCP Specification](#).

Since the size of a register is 16 bit, 32 bit Integers will have to be split up into two separate registers with each containing a half of the bits. In figure 37 you can see in what order the 32 bit are split up.

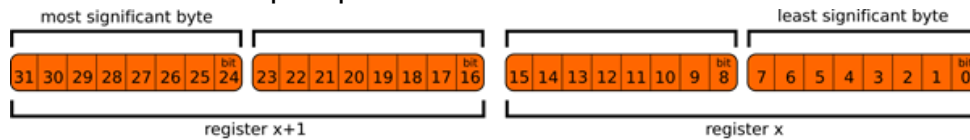

Figure 40:32 bit split up into 16 bit registers

In Figure 40 an example Modbus result is shown. The **Header** tells us in register 1 that we have 3 results available and in register 2 that an error with error code 4 occurred (target temperature not reached). Registers 3 and 4 contain the timestamp, which is 1561475754 seconds since January 1<sup>st</sup> 1970, corresponding to Tuesday, June 25<sup>th</sup> 2019 15:15:54. Of the 3 results you can only see 2, because they have been mapped to 7-12 and 13-18. The third result has been mapped into the range not shown. The concentration of **substance 1** was not within the calibrated range which can be identified by looking at register 10. This contains the value 2, which means, that the concentration is below the calibrated range. The concentration put into registers 7 and 8 is thus an invalid arbitrary value. The 1 in register 9 means, that the substance has been selected for evaluation. If **substance 1** wouldn't have been selected for evaluation, the other 5 registers would be empty and register 9 would contain a 2. **Substance 2** is mapped into the registers 13-18. The calculated concentration is 0.559 (559/1000 three decimal point precision) and mapped into registers 13 and 14. Whether this is within the calibrated precision can be seen in the calibration protocol you have been supplied with. Register 15 contains a 1 meaning the substance had been selected for evaluation. The concentration was within the calibration range, so the status code in register 16 is a 1.

Offset	Standard address	Hex	uint16	uint32
1	40001	0x0003	3	
2	40002	0x0004	4	
3	40003	0x3A...	15018	
4	40004	0x5D12	23826	1561475754
5	40005	0x0000	0	
6	40006	0x0000	0	
7	40007	0xFC18	64536	
8	40008	0xFFFF	65535	4294966296
9	40009	0x0001	1	
10	40010	0x0002	2	
11	40011	0x0000	0	
12	40012	0x0000	0	
13	40013	0x022F	559	
14	40014	0x0000	0	559
15	40015	0x0001	1	
16	40016	0x0000	1	
17	40017	0x0000	0	
18	40018	0x0000	0	
19	40019	0x0000	0	
20	40020	0x0000	0	
21	40021	0x0000	0	
22	40022	0x0000	0	
23	40023	0x0000	0	
24	(...) ↓	40024	0x0000	0
25		40025	0x0000	0

Figure 41: First 25 registers of an example Modbus result.

### 6.5.4 Substance Calibration Information Area

Substance specific calibration information such as used Averaging, Intensity type, Area, Search Ranges and the Quantification model name of the selected Substance in the Substances window are shown.

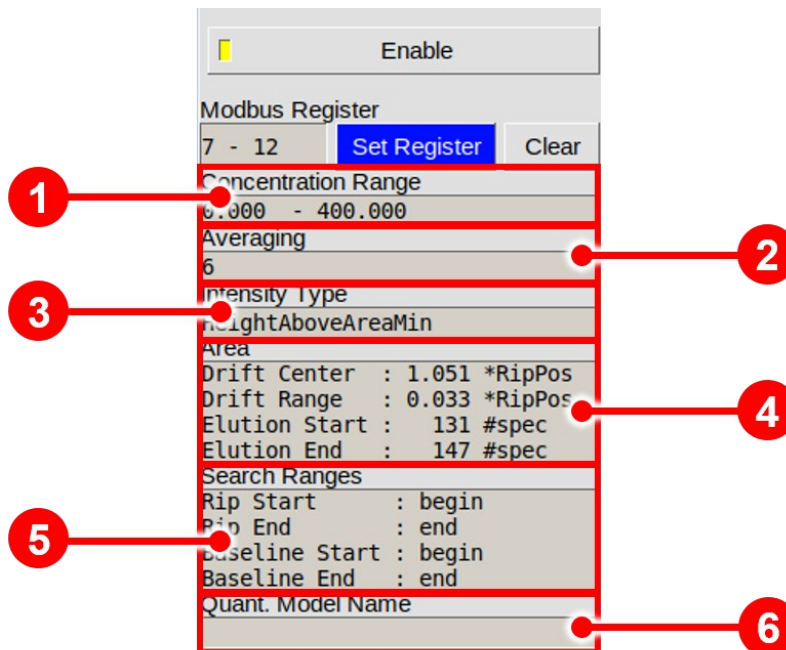
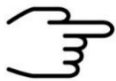

Figure 42: Substance Calibration Information Area

1	<b>Concentration Range</b>	Displays the used calibration range of the actual substance calibration file.
2	<b>Averaging</b>	Displays the used average of the actual substance calibration file.
3	<b>Intensity Type</b>	Displays the used intensity type of the actual substance calibration file.
4	<b>Area</b>	Displays the used area parameter of the actual substance calibration file.
5	<b>Search Ranges</b>	Displays the used search ranges of RIP and baseline of the actual substance calibration file.
6	<b>Quant Model Name</b>	Displays the quantification model name of the actual substance calibration file.



**INFORMATION!**

All substance calibration definition can be generated and saved as a “calibration.gsd” file in the G.A.S. software VOCal.

For detailed Information refer to the [VOCal Manual](#) and the [VOCal Tutorials](#).

**6.5.5 Recognised substances window**

When substances are enabled in the substance window the Recognised substances window appears at the end of every measurement. This screen displays a list with the results in a concentration unit which is defined in the valid calibration curve.

When a current loop is connected the last result of this list will be overwritten. By starting the next measurement the Recognised Substances window disappears until the next measurement will be finished.

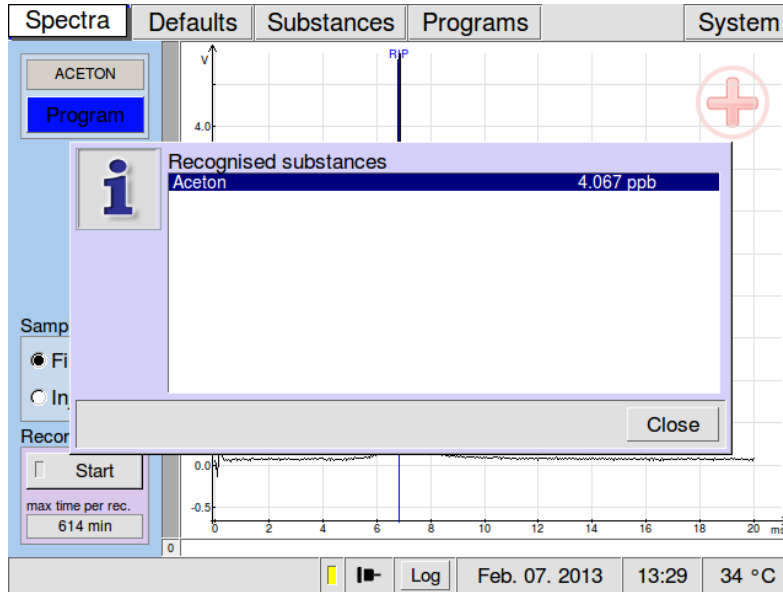

Figure 43: Recognized Substances Window

## 6.6 Programs Window



### WARNING!

Existing programs are no longer compatible after a firmware upgrade to version 4.50 and can no longer be executed. They must be adapted.

### 6.6.1 Overview

In the Programs window user-defined measurement programs can be selected, managed and edited.

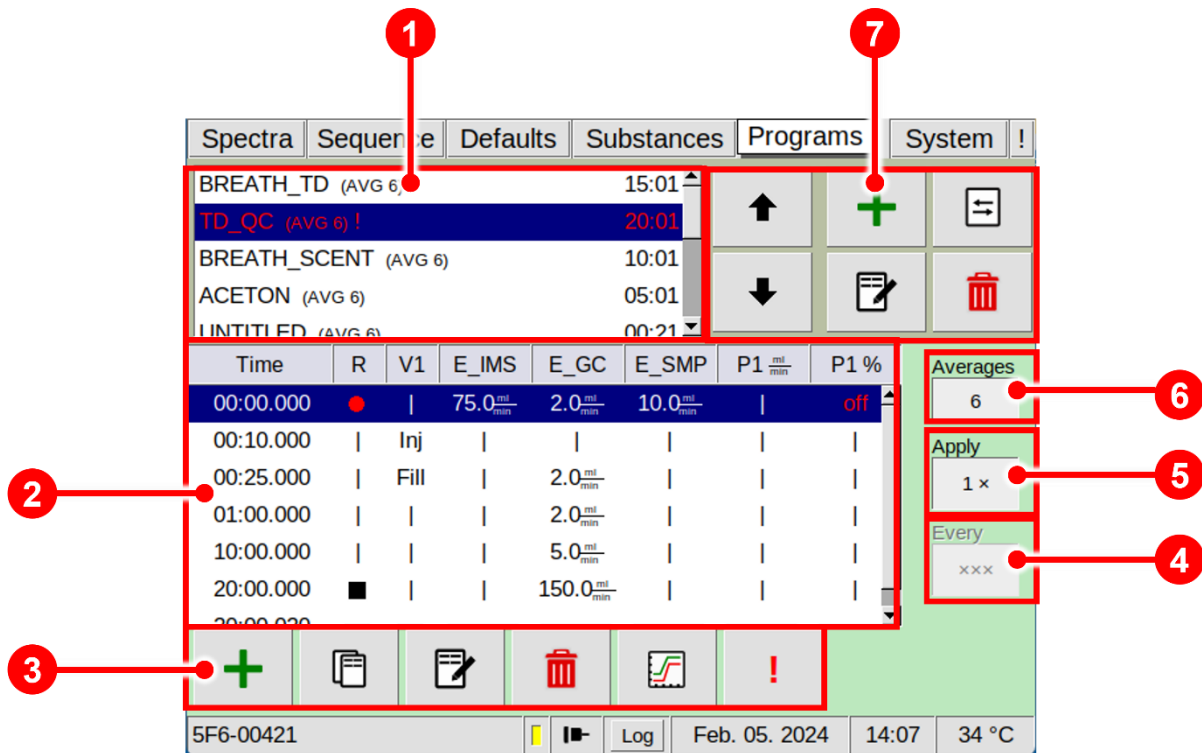
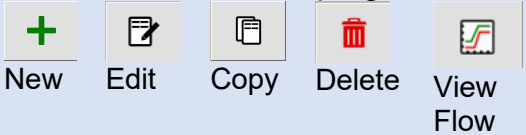
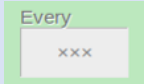
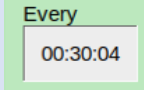
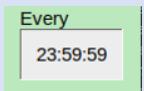
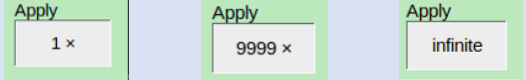
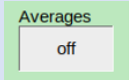
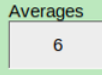
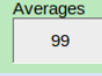

Figure 44: Operating Interface - Programs Window

<b>1</b>	<b>Program List Area</b>	All created measurement programs are listed in this box by name. The highlighted program is selected for execution (switch to the Spectra tab to start the measurement) or modification.
<b>2</b>	<b>Selected Program Area</b>	All instructions of a selected program are listed here in a chronological order. For every device component that can be

		<p>controlled by a program a separate column is displayed.</p>
<p><b>3</b></p>	<p><b>Selected Program Action Control Panel</b></p>	<p>Buttons for creating, changing or deleting actions of the selected program</p>  <p>New Edit Copy Delete View Flow</p>
<p><b>4</b></p>	<p><b>Program Repetition Time</b></p>	<p>The time interval for program repetitions can be set.</p> <p>The following settings are possible:</p> <div style="display: flex; flex-direction: column; gap: 10px;"> <div data-bbox="805 745 1348 828">  <p><b>No repetition interval set</b></p> </div> <div data-bbox="805 840 1364 1243">  <p><b>Minimum adjustable repetition interval</b> It is determined by the currently selected program length plus 4 seconds. (e.g. 30 min program length corresponds to 30min and 4 seconds minimum adjustable repetition interval.)</p> </div> <div data-bbox="805 1254 1316 1377">  <p><b>Maximum adjustable repetition interval</b> It is 23 h: 59 min: 59 sec.</p> </div> </div>
<p><b>5</b></p>	<p><b>Program Repetition Rate</b></p>	<p>The number of program repetitions can be set.</p> <p>Possible values are <b>1 to 9999</b> and <b>infinity</b>.</p> 
<p><b>6</b></p>	<p><b>Averages Setting</b></p>	<p>The Averaging of the IMS spectra in the selected program can be set. The current average is shown in brackets with the name of the measurement program.</p> <p>The following settings are possible:</p> <div data-bbox="805 1937 1300 2016">  <p><b>No averaging set (off)</b></p> </div>





		 	<p><b>Recommended standard averaging (6)</b></p> <p><b>Possible maximum averaging (99)</b></p>								
<p><b>7</b></p>	<p><b>Program Control Panel</b></p>	<p>Buttons for creating, changing or deleting actions of the selected program</p> <table border="1"> <tr> <td data-bbox="810 562 890 607">+</td> <td data-bbox="922 562 986 607">✍</td> <td data-bbox="1018 562 1098 607">⇄</td> <td data-bbox="1129 562 1193 607">🗑</td> </tr> <tr> <td data-bbox="810 618 890 651">New</td> <td data-bbox="922 618 986 651">Edit</td> <td data-bbox="1018 618 1098 696">Import Export Copy</td> <td data-bbox="1129 618 1193 651">Delete</td> </tr> </table>		+	✍	⇄	🗑	New	Edit	Import Export Copy	Delete
+	✍	⇄	🗑								
New	Edit	Import Export Copy	Delete								



### 6.6.2 Create Measurement Programs

The Program List Area displays all measurement programs currently existing. The measurement programs list can contain **up to 100 entries**. The defined Averages value is shown in brackets with the program name. The selected program name can be edited and a set of other program controls are available.



Figure 45: Program Control Panel

 <p><b>Up</b></p>	<p>The position in the list of the selected program can be moved upwards in steps.</p>
 <p><b>Down</b></p>	<p>The position in the list of the selected can be changed downwards in step.</p>
 <p><b>New</b></p>	<p>The New button which will open a keyboard window for entering the program name. It automatically creates a program template with default settings.</p>
 <p><b>Edit</b></p>	<p>By pressing the Edit button, the program name for the selected entry can be edited using a keyboard window.</p>

 <p><b>Import Export Copy</b></p>	<p>By pressing this button, a new window appears. Programs can be <b>imported</b>, <b>exported</b> and <b>copied</b></p>
 <p><b>Delete</b></p>	<p>By pressing the Delete button the program of the selected program will be deleted.</p>

Execution rules for a measurement program can be defined: With defining Every the Program Repetition Time interval can be set. The Program Repetition Rate can be chosen by setting a number of repeated executions in Apply.

Valid values for the Apply field range from **1x** (once, the default) **up to 9,999 repetitions** or **infinite**, which means the program will be repeated endlessly until the user cancels the measurement manually.

In the Averages field the average of the current selected program can be set. It is shown in brackets with the name of the measurement program.

The time span (hours, minutes, and seconds) between two program runs - more exactly between two program starts - is set in the “Every” field. Hence the minimum time span to be entered here is the duration of the currently selected measurement program as displayed in the programs list. Depending on the used averages the acquisition of spectra produces a large amount of data. The processing of this data can cause latency between program end and program restart of up to about 1 second.

### 6.6.3 Edit Measurement Programs

Each program consists of a list of chronologically ordered steps, so called actions. Upon selection of a program the program name is highlighted, and the Selected Program Area displays the list of actions for the currently selected program. Each row in this list shows the settings which will be applied to a device component at a defined time which is visible in the first row.

	1	2	3	4	5	6	7
	Time	R	V1	E_IMS	E_GC	E_SMP	P1 $\frac{ml}{min}$
8	00:00.000	●		75.0 $\frac{ml}{min}$	5.0 $\frac{ml}{min}$		115.0 $\frac{ml}{min}$
	00:10.000		Inj				
	00:16.000		Fill				
	30:00.000	■			50.0 $\frac{ml}{min}$		
9	30:00.020	—	—	—	—	—	—

Figure 46: Selected Program Window

- 1 **Time:** Time point of action start
- 2 **R:** Start / Stop recording spectra **Start = ●** **Stop = ■**
- 3 **V1:** Switch the Valve Position **(Inj / Fill)**
- 4 **E\_IMS:** Flow rate control for drift gas (EPC\_IMS) **(0- 500 ml/min)**
- 5 **E\_GC:** Flow rate control for carrier gas EPC\_GC **(0- 150\* ml/min)**
- 6 **E\_SMP:** Flow rate control for uTD sample gas EPC\_SMP **(0- 150\* ml/min) optional**
- 7 **P1:** The sample flow rate can be set in ml/min depending on the settings of the pump control
- 8 Selected programs start action line

9

End of program line

**INFORMATION!**

The E\_GC maximum flow (carrier gas) of 150 ml/min is restricted by the installed column dimensions. The maximum value only can be reached if the standard column of the standard GC-IMS instrument is installed (15 m length, 0.53 mm inner diameter). **Using the BreathSpec instrument with the application specific GC-column (MXT-WAX , Length 30 m, 0.32 mm inner diameter) the EPC\_GC maximum flow is limited to ~80 ml/min.**

Each value defined determines the new state of the respective device component. A vertical line “|” indicates that the respective device component is not changed in this action.

The last row in this action list contains horizontal lines only. It indicates the end-of-program. The point of time of this end-of-program marker can be increased. This determines the duration of the program run.





Figure 47: Selected Program area Control Panel

With the buttons visible below the Selected Program Area a Control Panel is active with which the currently displayed program can be reviewed, action lines can be added or copied, edited or deleted. A newly created action is inserted after the currently selected action line. Pressing the Copy button copies the selected action and orders the copy behind the selected action. Carefully review the Start Time of each action line to manage the sequence of each action in the program by pressing the Del button, the currently selected action is deleted. Pressing the Edit button or the New button opens the Edit Action dialogue.

- 

The **Plus** button will insert a new action line after the currently selected action line
- 

The **Copy** button which will copy the current action-line and display it with an incremented start time after the currently selected action line .
- 

By pressing the **Edit** button, the program name for the selected entry can be edited using a keyboard window.
- 

By pressing the Delete button the program of the selected program will be deleted.
- 

By pressing **View Flow Graph** button shows the graphical EPC\_IMS- EPC\_GC- EPC\_SMP-, EPC\_PC-flow, VALVE1- and REC-state of the currently selected program.
- 

The **Program Warning** button is only displayed if a programme is not available in the required programme structure from firmware 4.50 onwards. The program can then be adapted in this window. Incompatible programmes are highlighted in red and cannot be executed.

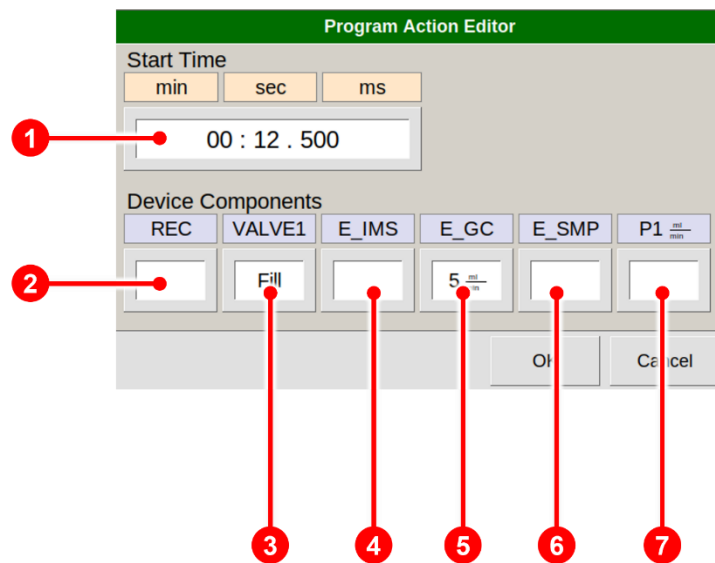

Figure 48: Program Action Editor

<b>1</b>	<b>Start Time</b>	Time when action is executed
<b>2</b>	<b>Recording</b>	Start / Stop recording spectra (rec ● / stop ▸)
<b>3</b>	<b>Valve</b>	Fill / Inject sample
<b>4</b>	<b>Electronic pressure control IMS</b>	Drift gas flow rate ramp set point (0- 500 ml/min)
<b>5</b>	<b>Electronic pressure control GC</b>	Carrier gas flow rate ramp set point (0- 150 ml/min)
<b>6</b>	<b>Electronic pressure control SMP (optionally)</b>	uTD gas flow rate ramp set point (0- 150 ml/min) Standard:10 ml/min
<b>7</b>	<b>Sample Flow P1</b>	Sample flow rate setpoint in ml/min depending on the settings of the pump control.

Pressing the **View** button shows a graphical view of the created program.

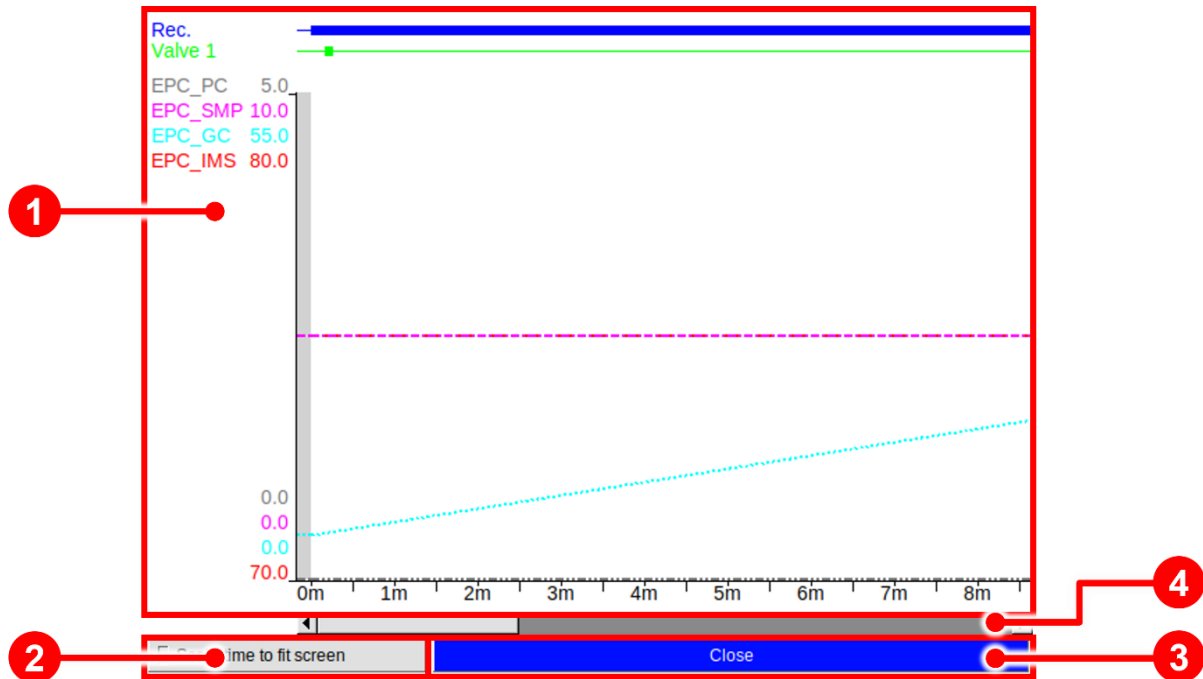

Figure 49: Program Action View

<b>1</b>	<b>Graphical View Display</b>	Displays the Program parameter EPC_IMS, EPC_GC, EPC_SMP, EPC_PC, VALVE1 and REC
<b>2</b>	<b>Scale time to fit screen Button</b>	Adjusts the display to the screen
<b>3</b>	<b>Close</b>	Closes the graphical view
<b>4</b>	<b>Scrollbar</b>	Shifts the current time view area

### 6.6.4 Flow Ramps

The flow rate set points in a measurement program determine the target flow rates at the specified time index. If set points differ from the default flow rate or varying flow rate set points are specified in a program, the course of the actual flows will be conducted as a linear ramp of the flow. Starting point of the ramp is the latest set

point. If no earlier set point is given the ramp starts with program initialization using the default set point.



**INFORMATION!**

If the flows in the default setting deviate from the start values in the program, the user is alerted by a visual signal (start button flashes in the Spectra window and in trigger mode).

An **exemplary program** using dynamic flow rates is visualized in the following figure:

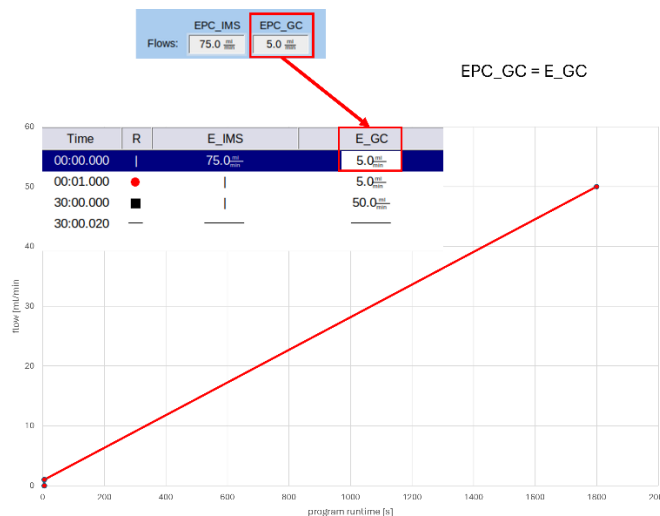

Figure 50: Flow Ramps

The E\_GC (carrier gas flow) value is initially set to 5 ml/min. Between runtime 1 sec – 30 min the flow is linearly increased to the target value 50 ml/min.



**INFORMATION!**

Before starting a measurement make sure that the highest flow set points can be achieved. Note that large changes in the flow set points will need finite time.



**INFORMATION!**

Please make sure that default values of EPC\_IMS and EPC\_GC (Default window) corresponds with the start value of E\_IMS and E\_GC in the program, otherwise the reproducibility of the measurement cannot be guaranteed.



**INFORMATION!**

Make sure that the EPC\_GC start pressure is reached again at the beginning of the next program run.

**RECOMMENDATION:**

Make sure that the initial flow at EPC\_GC is kept constant during the first 60 seconds after injection before starting a flow ramp, especially when a low flowrate is chosen.



**INFORMATION!**

GC normalization of retention times to retention indices for substance identification is based on measurements of the retention times of known compounds (e.g. from the custom ketone standard). This normalization can be done, for example, using the VOCal software.

Between the measured points the retention indices are interpolated. It is therefore recommended to set a uniform slope of the carrier gas flow ramp to avoid flow changes or retention index jumps.



**INFORMATION!**

For detailed Information about substance identification refer to the [VOCAL Tutorials](#).

## 6.7 System Window

In the System Window system specific information is displayed and can be set.

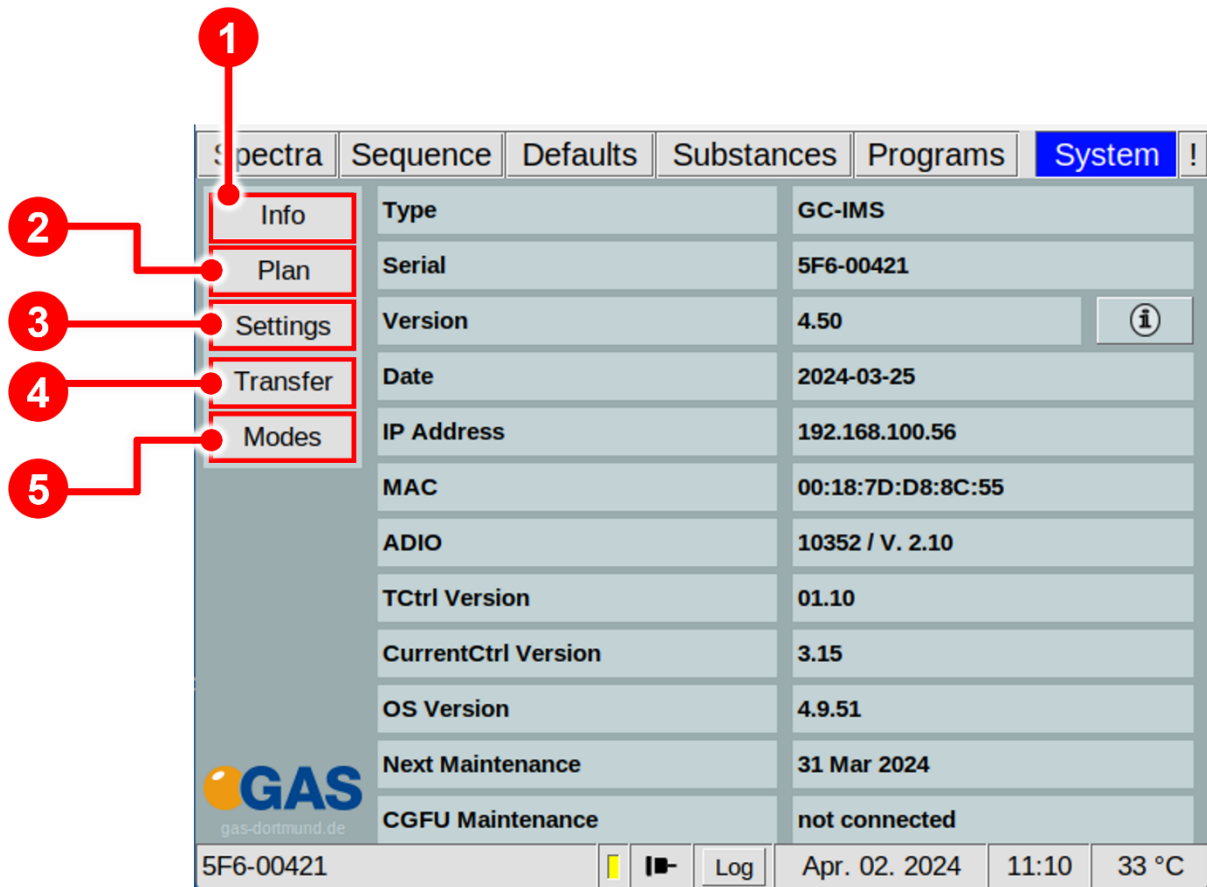

Figure 51: Operating Interface - System Window

<b>1</b>	<b>Info Button</b>	Displays the System Information Window
<b>2</b>	<b>Plan Button</b>	Displays the Device Plan Window
<b>3</b>	<b>Settings Button</b>	Displays the Settings Window. Various device parameter like Export Setting, Livedata output, Device attributes can be set.
<b>4</b>	<b>Transfer Button</b>	Displays the current data transfer settings. Data transfer settings can be set.
<b>5</b>	<b>Modes Button</b>	Special application modes can be set.

6.7.1 System Info Window

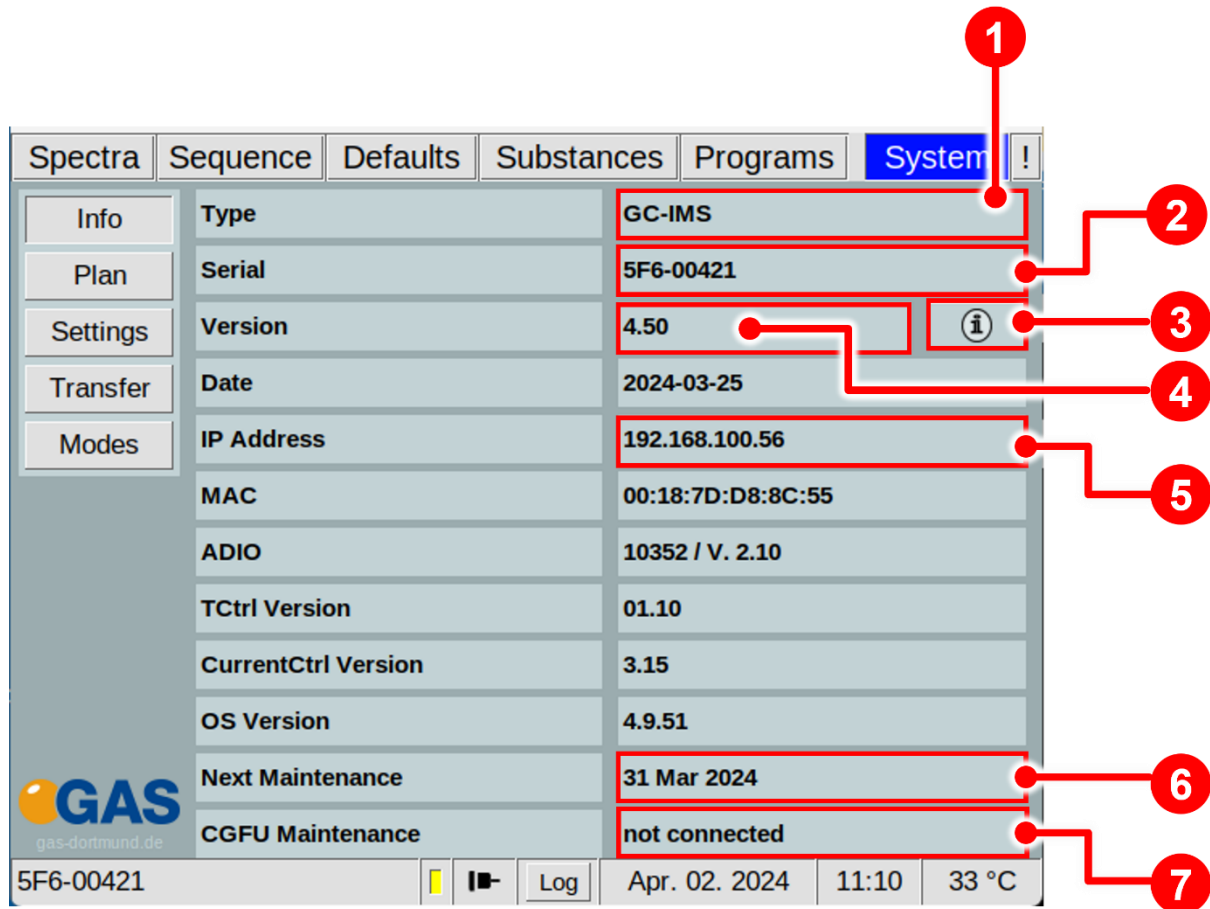

Figure 52: Operating Interface - System Info Window

<b>1</b>	<b>Type</b>	Device type.
<b>2</b>	<b>Serial</b>	Device Serial Number.
<b>3</b>	<b>Version</b>	Current Firmware Version.
<b>4</b>	<b>Date</b>	Date of current Firmware Version.

<b>5</b>	<b>IP-address</b>	Displays the current IPv4-Address.
<b>6</b>	<b>Next Maintenance</b>	Displays the next maintenance date.
<b>7</b>	<b>CGFU Maintenance</b>	Displays the next maintenance date ( <b>only if CGFU is connected!</b> )

### 6.7.2 System Plan Window

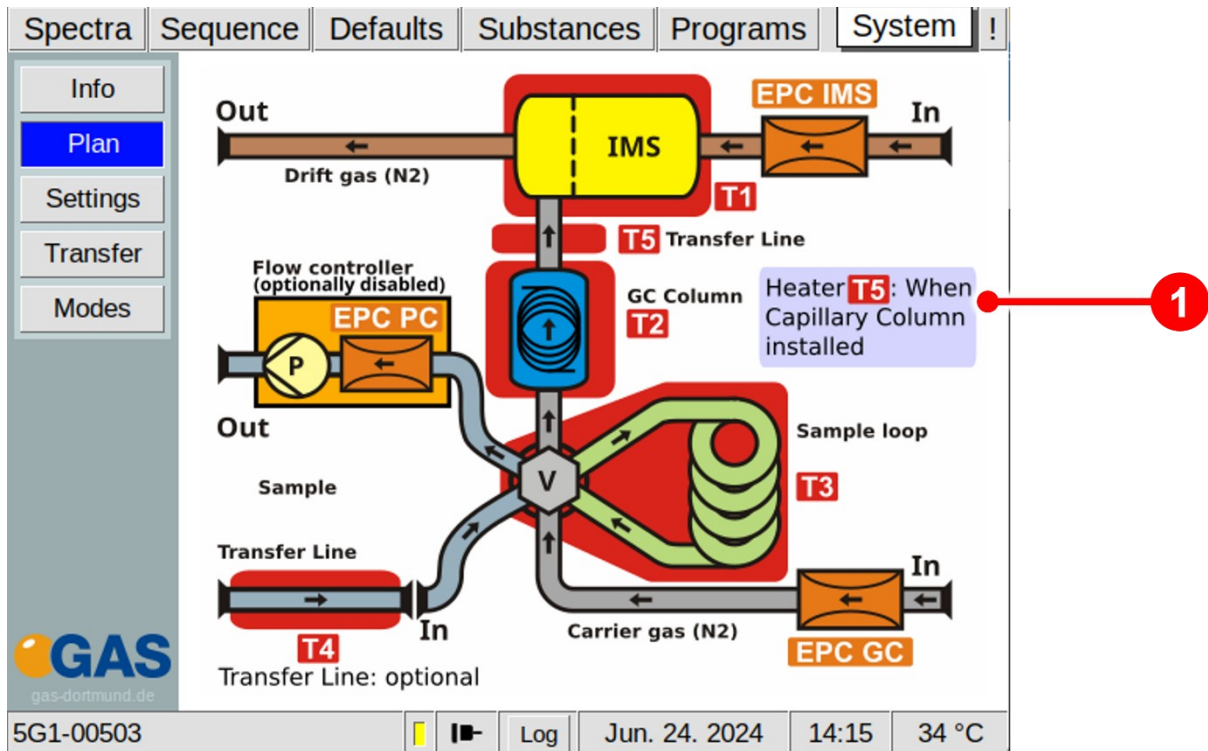

Figure 53: Operating Interface - System Plan Window

<b>1</b>	<b>Plan</b>	Displays an overview plan of the device
----------	-------------	---

### 6.7.3 System Settings Window

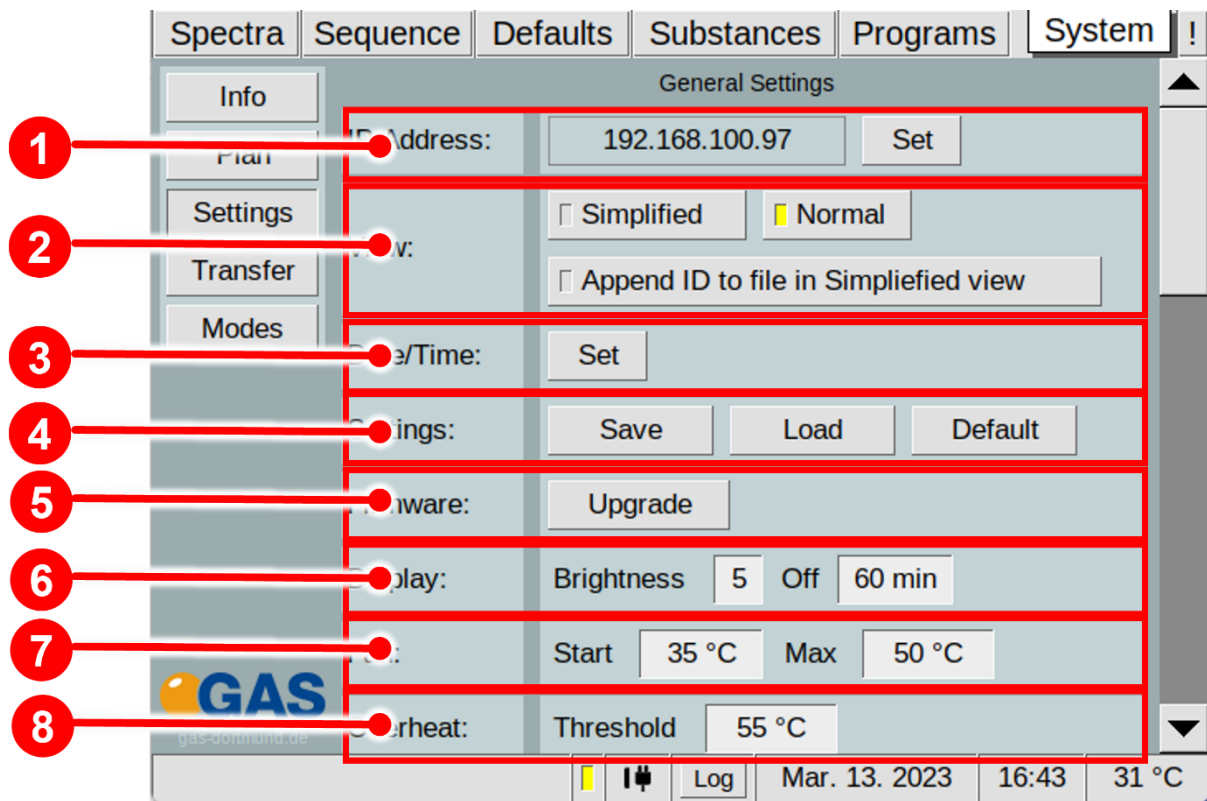

Figure 54: Operating Interface - System Settings Windows 1

1	<b>IP Adress</b>	Displays the current set IPv4-Adress of the device. With <b>Set-button</b> the IPv4-adress can be set
2	<b>View</b>	Toggles between simplified and normal view. Activating the Append ID to file in Simplified view Button, stores the entered ID in the metadata of the measurement.
3	<b>Date/Time</b>	With <b>Set-button</b> the Date and Time can be set
4	<b>Settings</b>	<p><b>Save button:</b> The system settings can be saved to a connected USB volume.</p> <p><b>Load button:</b> The system settings can be loaded from a connected USB volume.</p> <p><b>Default button:</b> Resets all system settings to factory default values. All measurement-programs and substance-entries set by user will be deleted.</p>

5	Firmware	With <b>Upgrade button</b> a firmware upgrade can be performed from a connected USB volume.
6	Display	The display brightness and screen-saver time-out can be set.
7	Fan	The behaviour of the cooling fan can be set. When the temperature inside the device reaches the temperature in the field Start the cooler fan starts working. The power of the cooler fan is increased up to the desired temperature of the value in the field Max.
8	Overheat	The threshold temperature for the overheat alarm can be set.

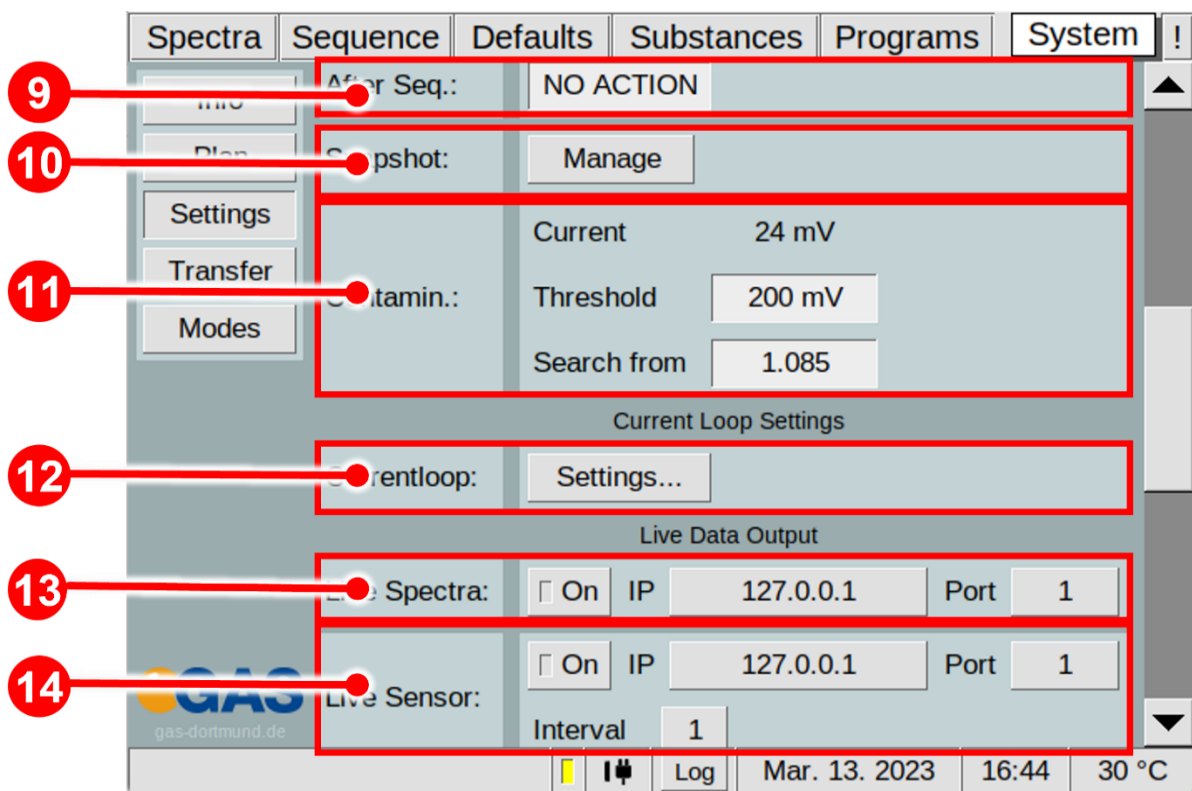

Figure 55: Operating Interface - System Settings Windows 2

9	After Seq.:	The After Sequence Action can be set. The following options are available: <b>No Action, Cleaning, Standby, Custom</b> .
10	Snapshot	The <b>Manage Button</b> opens the snapshot window. User-specific target values can be set. A new snapshot can be recorded or can be imported Snapshot is a new function to allow automatic instrument performance checking
11	Contamin	Define the automatic search area for contamination. The search window can be defined by setting the Threshold (signal level in mV which is recognised as a contamination) and the Start of the search in the drift-time spectrum given as RIP relative proportional factor. <ul style="list-style-type: none"> <li>• <b>Current:</b> Shows the currently detected contamination Shows the currently detected contamination.</li> <li>• <b>Threshold:</b> The set value from which an error is triggered.</li> </ul> <b>Search from:</b> The RIP-relative starting position of the search.
12	Current Loops (optional)	Activating the <b>Settings button</b> opens a current loop setup dialog (only visible if available)
13	Live Spectra:	<b>Prepared for further use! Currently not in function!</b>
14	Live Sensor:	The settings for Live Data communication with G.A.S. Sequence Designer Software can be set. For detailed Information refer to the G.A.S. Sequence Designer Software Manual.



**INFORMATION!**

The device is delivered with an acceptance snapshot. This snapshot defines the system performance during device

acceptance and is used to assess the readiness for measurement. Any deviations from this are displayed in the Error Information Window. **The default values can be adjusted by the customer.**

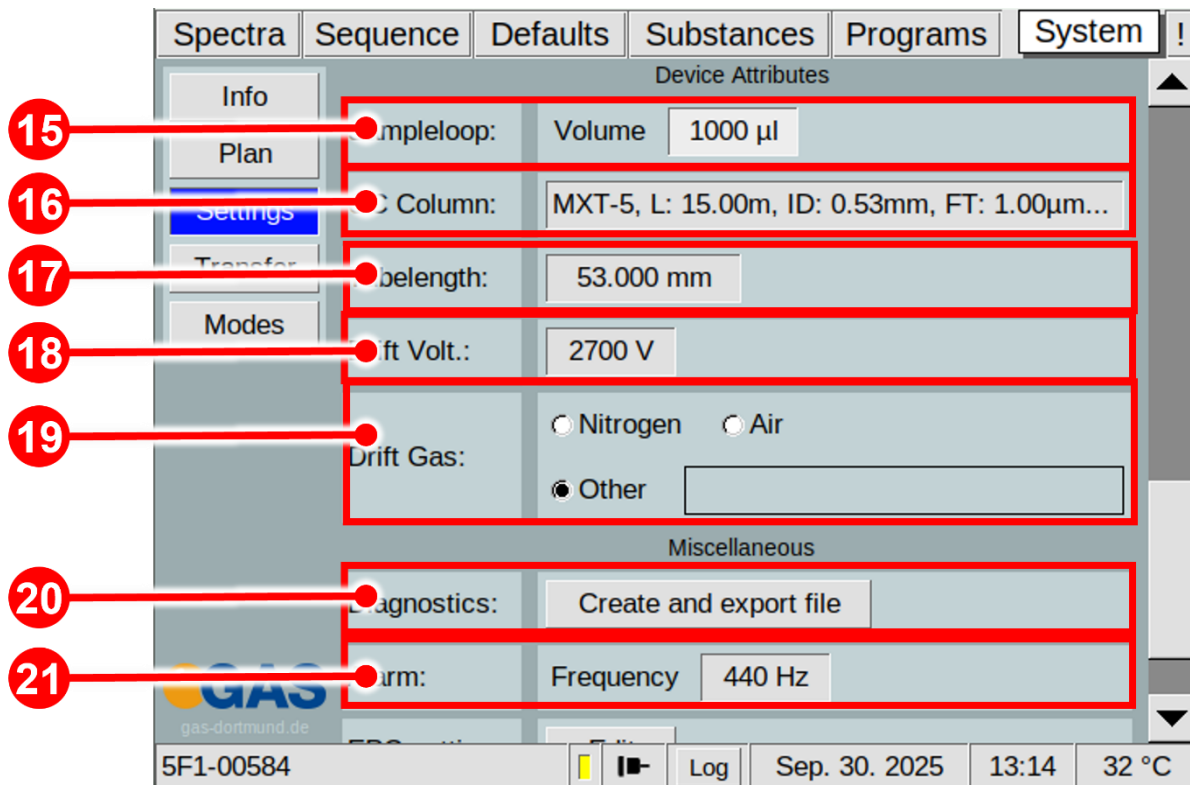

Figure 56: Operating Interface - System Settings Windows 3

15	<b>Sample loop:</b>	The Sample Loop Volume can be set. This data is stored in the metadata of the measurement. The standard value is 1000 µl.
16	<b>GC Column:</b>	Input filed for Column ID. The Column data editor window open to enter the Column-ID- The value is stored with measurement file. This data is stored in the metadata of the measurement.
17	<b>Tubelength:</b>	Setting the length of the drift tube
18	<b>Drift Volt.:</b>	Setting of the applied drift voltage

<b>19</b>	<b>Drift Gas:</b>	Selection field for operating gas type. The value is stored with measurement file.
<b>20</b>	<b>Diagnostics:</b>	With <b>Create and export file-Button</b> an encrypted diagnostic file is created for diagnostic purposes by G.A.S..
<b>21</b>	<b>Alarm:</b>	The frequency of the warning sound can be set.

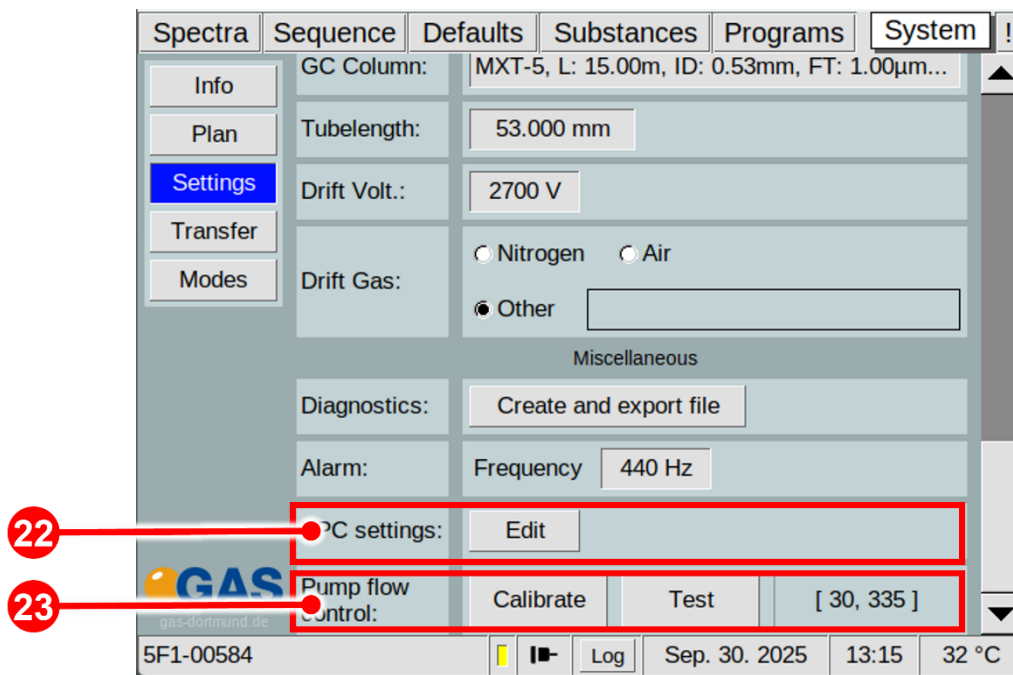

Figure 57: Operating Interface - System Settings Windows 4

<b>22</b>	<b>EPC settings</b>	The gas types for the available EPCs can be selected individually
<b>23</b>	<b>Pump Flow control</b>	The acceptable MIN and MAX sample flow can be tested and calibrated here.

**INFORMATION!**

The screen interface can be switched from English to Chinese as of firmware version 4.70.

The language can be changed in the system window line Language.

**This line is only available for systems for the Chinese market.**

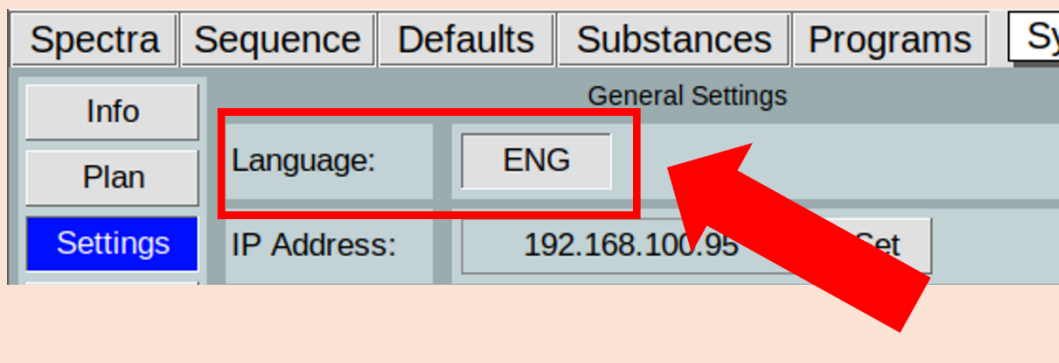

### 6.7.3.1 Snapshot Window

The instrument performance and status can be monitored using recorded snapshots. Snapshot details can be viewed in the Snapshot window. It is needed for an automatic comparison of current instrument settings versus the operator defined target settings which helps the operator to assess the readiness of the system for starting a measurement. This automatic monitoring can recognize among other a System contamination, insufficient gas quality or system leaking. For this purpose, the following parameters are constantly cross-checked against the target-settings:

- The carriergas pressure – EPC\_GC pressure (kPa)
- The height of the Reaction-Ion-Peak (RIP) - Rip-height (V)
- The position of the Reaction-Ion-Peak (RIP) normalized to normal pressure – Rip Pos at 101.33 kPa (ms)
- The full width at half maximum of the Reaction-Ion-Peak - FWHM (ms)
- The temperature values T1-T6
- The gasflow and pressure of Driftgas (EPC\_IMS) and Carriergas (EPC\_GC)

The user can change the default factory settings for his needs. Error messages are displayed in the Error Information Window.

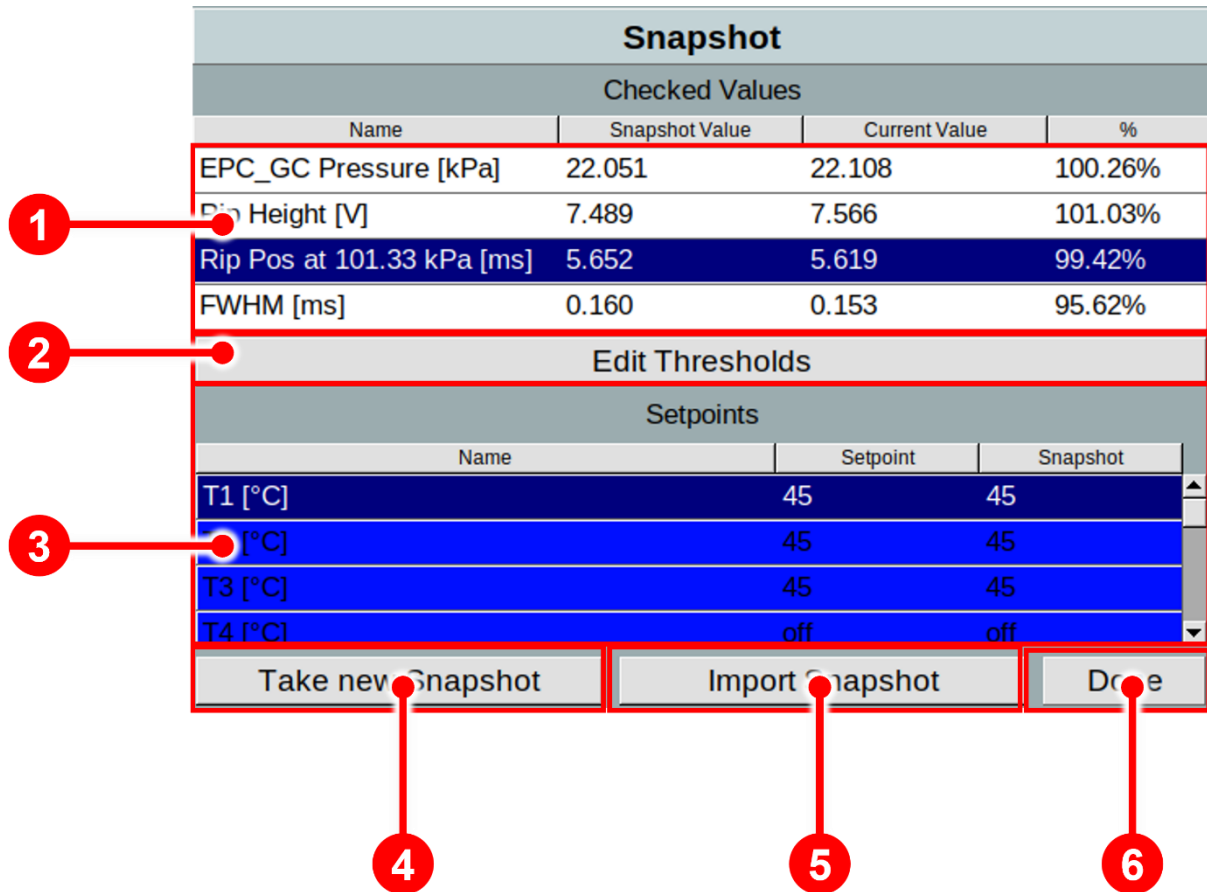

Figure 58: Operating Interface – Snapshot Window

<b>1</b>	<b>Checked values Area</b>	The checked Snapshot values (EPC_GC Pressure; Rip Height, Rip-Position at 101,33 kPa, Rip-half-value width FWHM) are displayed.
<b>2</b>	<b>Edit Threshold</b>	The selected Snapshot values (EPC_GC Pressure; Rip Height, Rip-Position at 101,33 kPa, Rip-half-value width FWHM) can be edited.
<b>3</b>	<b>Setpoints Area</b>	Display of the current setpoints and the corresponding snapshot values.
<b>4</b>	<b>Take new Snapshot Button</b>	Take a new snapshot of the current system status.

<b>5</b>	<b>Import Snapshot Button</b>	Import a Snapshot-file with prepared values by G-A.S.
<b>6</b>	<b>Done Button</b>	Closes the snapshot window

### 6.7.3.1.1 Snapshot window in detail

The system is delivered with standard limits for EPC\_GC-Pressure, RIP-Height, RIP Position at 101.33 kPa and FWHM. The upper and lower limits of these parameters can be adjusted by the operator.

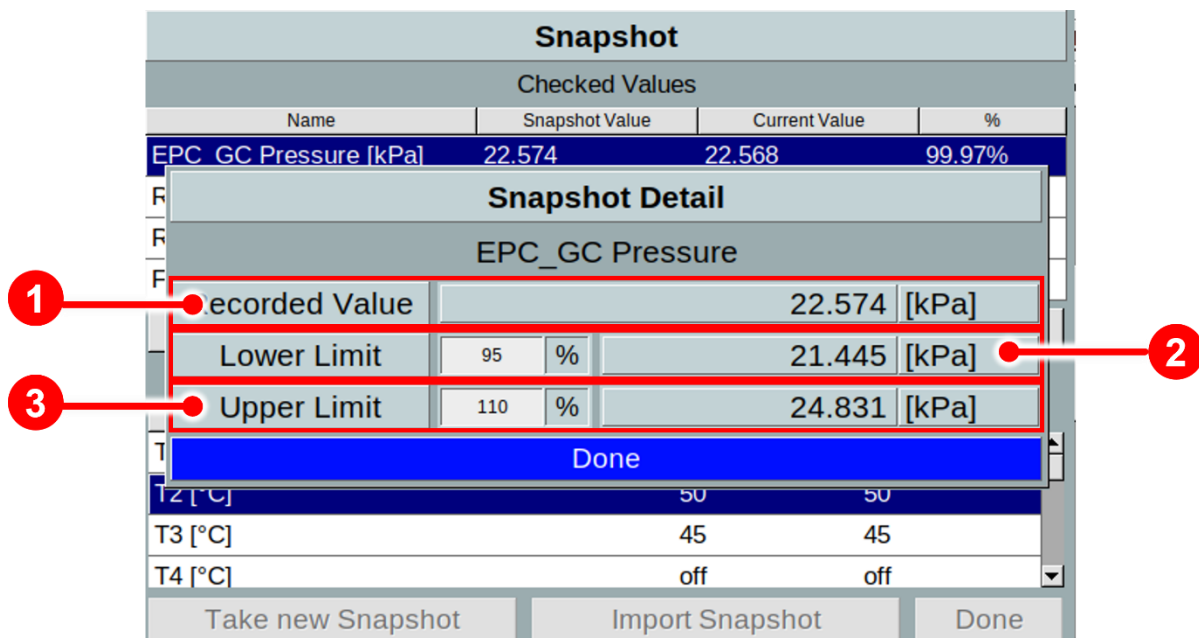
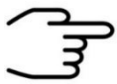

Figure 59: Operating Interface – Snapshot Window in detail (example EPC\_GC pressure)

<b>1</b>	<b>Recorded Value</b>	Displays the current recorded snapshot value (Example EPC_GC pressure).
<b>2</b>	<b>Lower Limit</b>	The lower limit of the current recorded snapshot value (Example EPC_GC pressure) is displayed. This limit can be specified by the user.
<b>3</b>	<b>Upper Limit</b>	The upper limit of the current recorded snapshot value (Example EPC_GC pressure) is displayed. This limit can be specified by the user.

Factory default limits		
Name	Lower limit (%)	Upper limit (%)
EPC_GC-Pressure (kPa)	95	110
RIP Height (V)	80	150
RIP Position at 101.33 kPa (ms)	95	105
FWHM (ms)	80	120



**INFORMATION!**

The device is delivered with an acceptance snapshot. This snapshot defines the system performance during device acceptance and is used to assess the readiness for measurement. Any deviations from this are displayed in the Error Information Window. **The default values can be adjusted by the operator.**

### 6.7.3.2 GC Column parameter setting

The input of the column identifier follows a defined nomenclature. This should be noted, as it is necessary for the evaluation with VOCal-Software.

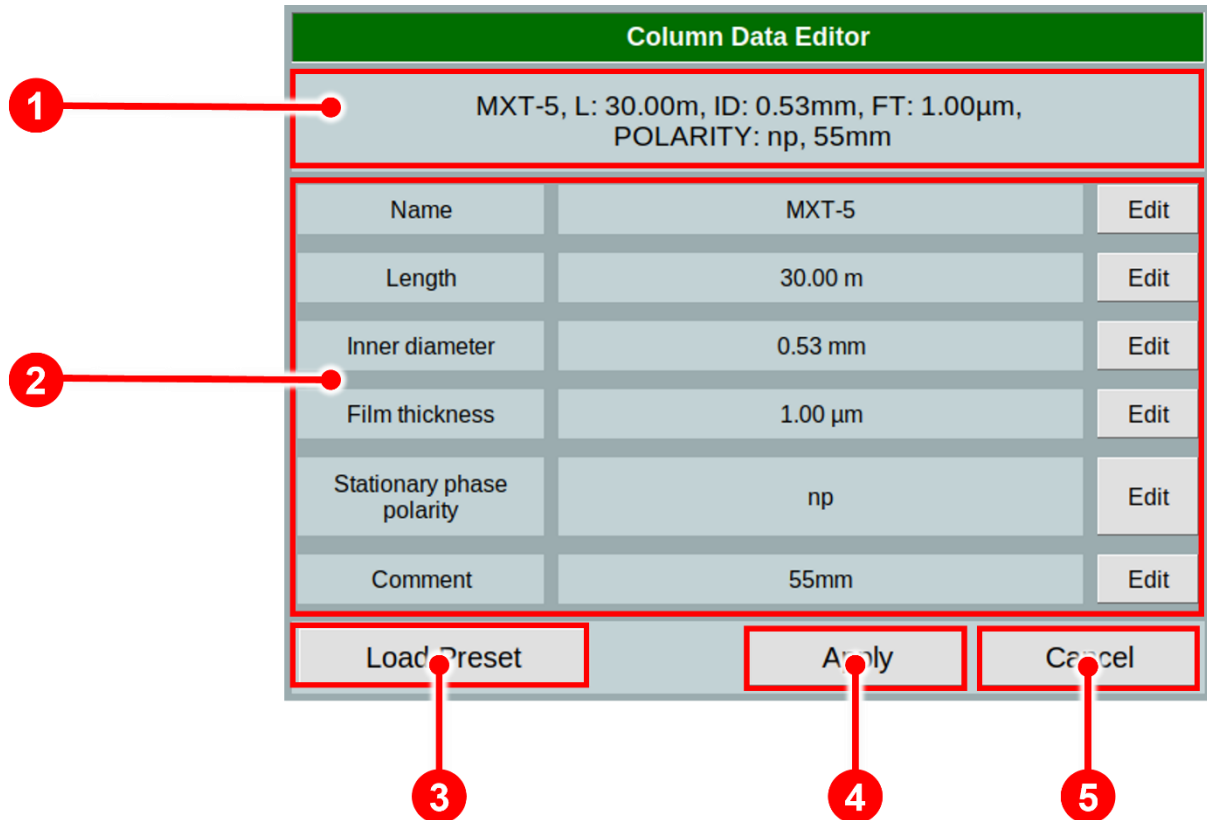

Figure 60: Operating Interface – Column Data Editor Window

<b>1</b>	<b>Column display windows</b>	Displays the specifications of the currently installed GC-column
<b>2</b>	<b>Parameter input window</b>	<p>The following column parameters can be set manually:</p> <p><b>Name</b> (Max. 30 characters)</p> <p><b>Length</b> (Min. 0.05 m – Max. 10.00 m)</p> <p><b>Inner diameter</b> (Min. 0.01 mm – Max. 10.00 mm)</p> <p><b>Film thickness</b> (Min. 0.01 µm – Max. 8.00 µm)</p> <p><b>Stationary phase polarity</b> (polar, non-polar, other)</p> <p><b>Comment</b> (Max. 30 characters)</p>

<b>3</b>	<b>Load Preset</b>	GC columns can be selected from a list as preset .
<b>4</b>	<b>Apply</b>	The selected parameters are applied.
<b>5</b>	<b>Chancel</b>	The selection is cancelled. The selected parameters are not applied

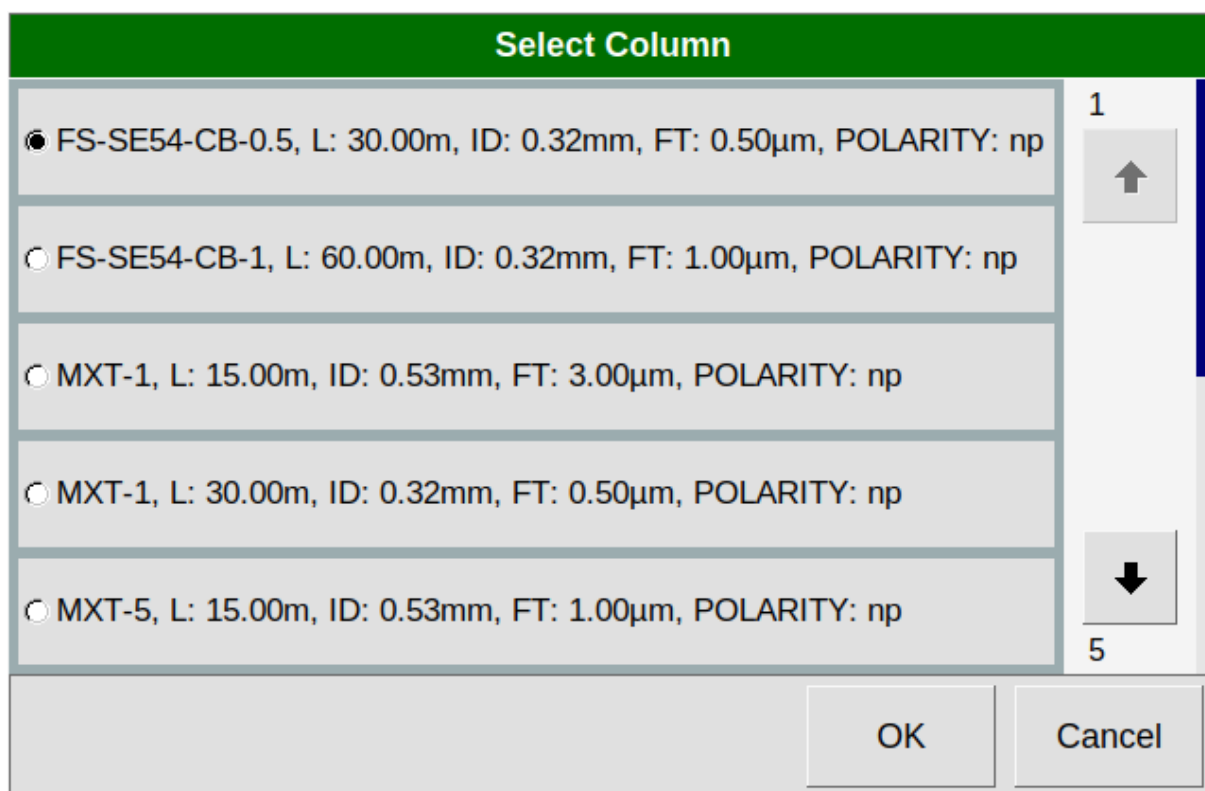

Figure 61: Column Selection Window



**INFORMATION!**

The column properties, especially the column polarity is an important information for the molecule identification in VOCal. VOCal can automatically suggests the applicable NIST RI Libraries

### 6.7.3.3 EPC parameter setting

The gas type used for the installed EPC can be set by the user. The default setting is nitrogen. The gas types usually used in ion mobility spectrometry are nitrogen and air in quality level 5.0

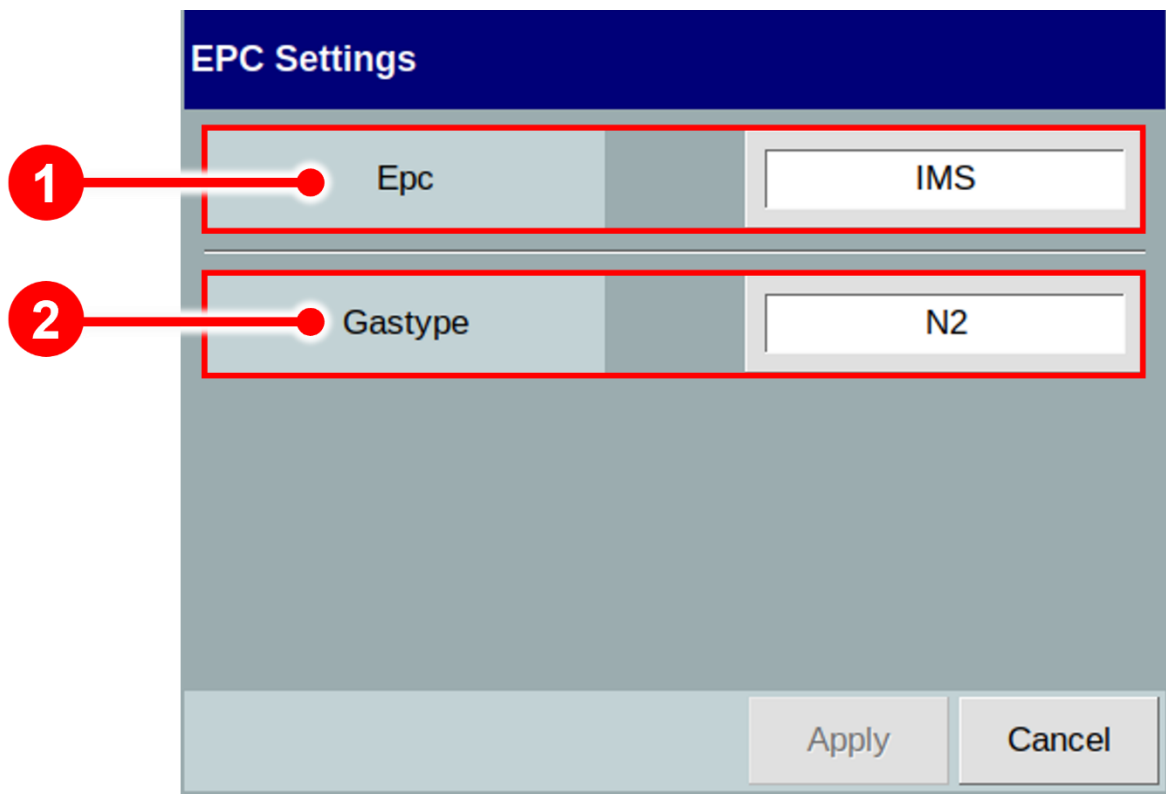

Figure 62: EPC Settings Window

<b>1</b>	<b>EPC</b>	The EPCs installed in the device can be selected.
<b>2</b>	<b>Gastype</b>	<p>A gas type can be assigned to the currently selected EPC. The following gas types are available:</p> <ul style="list-style-type: none"> <li>• Air</li> <li>• Nitrogen (N<sub>2</sub>)</li> <li>• Helium (He)</li> <li>• Argon (Ar)</li> <li>• Oxygen (O<sub>2</sub>)</li> <li>• Carbon dioxide (CO<sub>2</sub>)</li> </ul>

### 6.7.3.4 Simplified View Window

The simplified view, when activated, is showing a different **Start** screen, it is restricting the functionality of the BreathSpec Firmware to allow access to only two essential measurement actions:

- entry of a measurement ID or a panellist ID which is traceable
- start the measurement.

With this restricted access it can be prevented that non trained BreathSpec operators can change important instrument parameters accidentally.

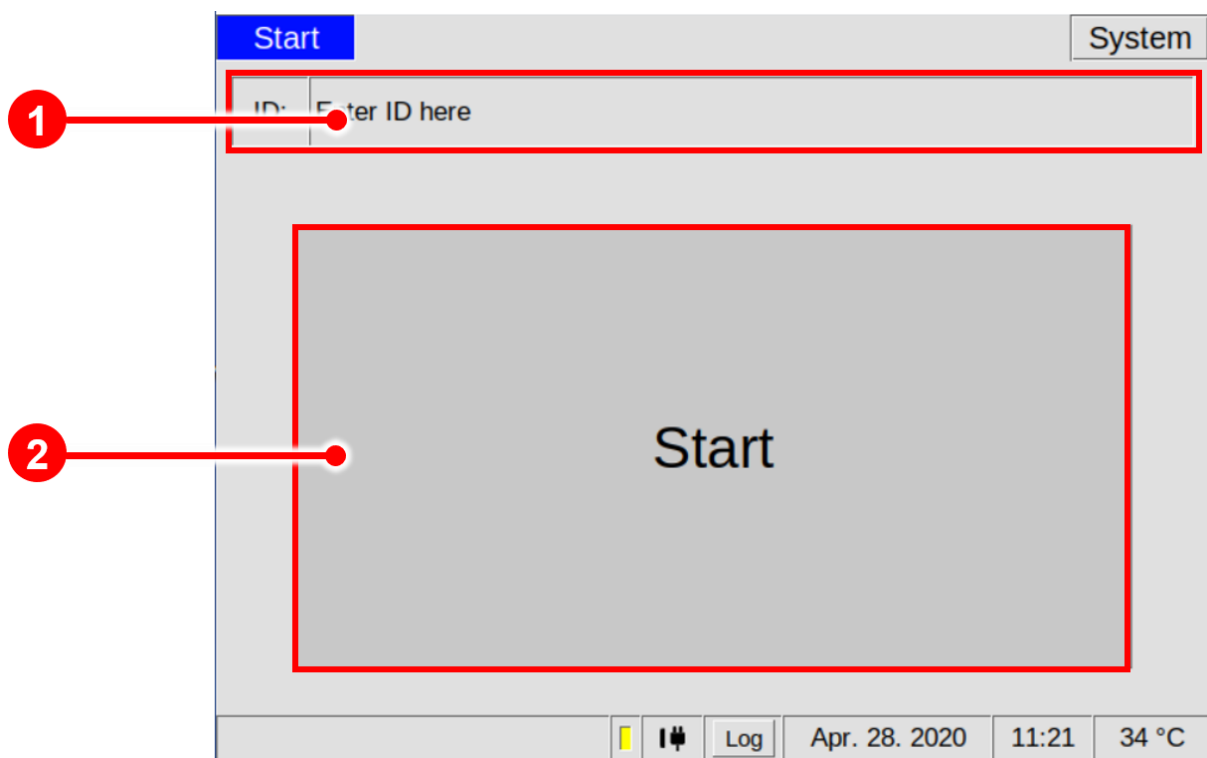

Figure 63: Operating Interface - Simplified View Window

<b>1</b>	<b>ID</b>	A measurement identification can be specified by the customer.
<b>2</b>	<b>Start Button</b>	By selecting this button, the current program is initialized.

## 6.7.4 System Transfer Window

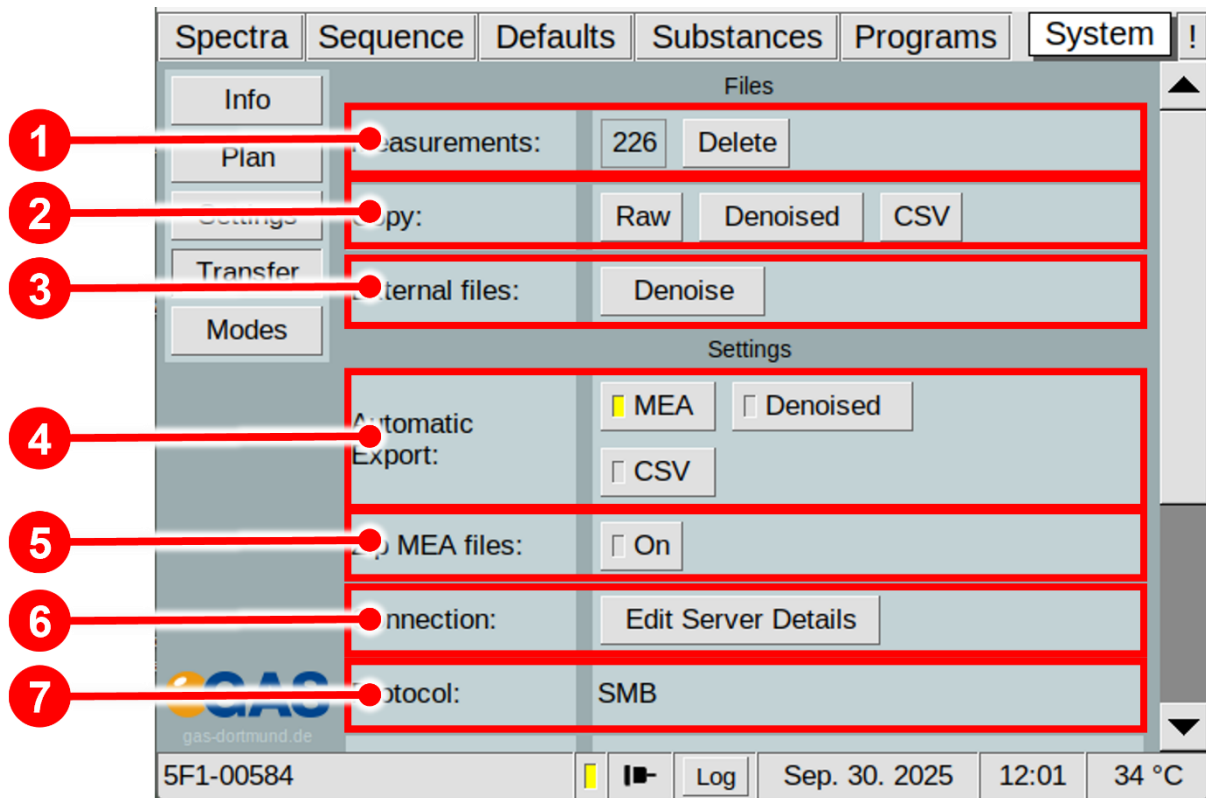

Figure 64: Operating Interface - System Transfer Window1

1	<b>Measurements:</b>	<p>The current number of internal stored measurement files and the following measurement file managing options are displayed and available:</p> <p><b>Delete:</b> Select the internal stored measurement files for deleting.</p>
2	<b>Copy:</b>	<p>The internal stored measurement files can be manage:</p> <p><b>Raw:</b> Copy the internal stored measurements to a connected USB device or to the connected shared folder.</p> <p><b>Denoised:</b> Copies a denoised version generated from the measured raw file to a connected USB device or to the connected shared folder.</p> <p><b>CSV:</b> Copies a CSV version generated from the measured raw file to a</p>

		connected USB device or to the connected shared folder.
3	<b>External files:</b>	A raw file can be loaded into the system and subsequently denoised. This file can then be saved using the copy functions.
4	<b>Automatic Export:</b>	<p>Automatic Export ensures that the generated measurement files are exported automatically. By activating this function, various formats can be specified:</p> <p><b>Mea</b>: the raw files</p> <p><b>Denoised</b>: the denoised files generated from the raw files.</p> <p><b>CSV</b>: result file in CSV format generated from the raw files</p>
5	<b>ZIP MEA Files:</b>	Compresses the measurement data to zip if activated.
6	<b>Connection:</b>	With <b>Edit Server Details</b> button the Export settings (transfer protocol, IPv4-adress, shared folder name) can be set.
7	<b>Protocol:</b>	Displays the current used transfer protocol ( <b>smb</b> , <b>sftp</b> or <b>tftp</b> ).

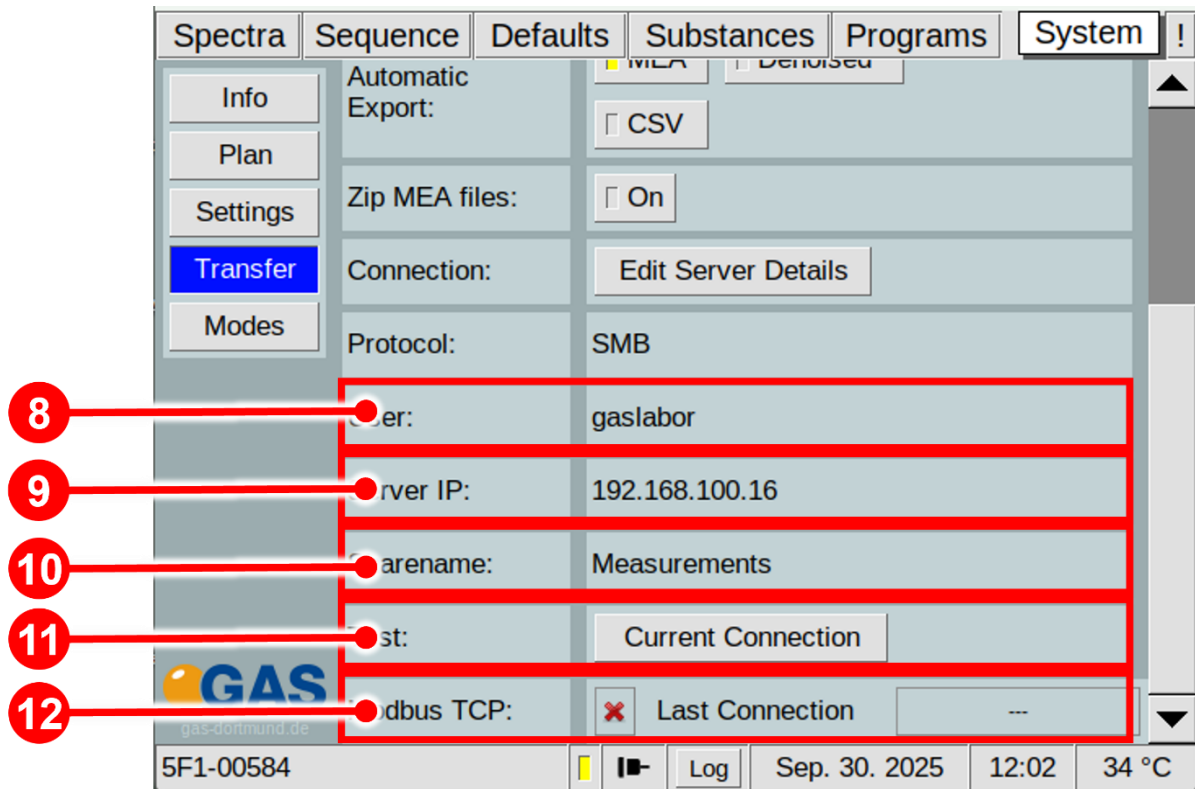

Figure 65: Operating Interface - System Transfer Window2

8	<b>User:</b>	Displays the current used user name.
9	<b>Server IP:</b>	Displays the current used IPv4-address.
10	<b>Sharename:</b>	Displays the current used sharename of the storage folder.
11	<b>Test:</b>	With <b>Current Connection</b> button the device tries to establish to the shared folder using the current export settings. A message will appear to indicate if the connection was successful or not.
12	<b>Modbus TCP</b>	The last Modbus TCP connection can be checked. It will give you information on when and from which IP the last connection was made and whether it is still active.

## 6.7.5 Measurement files

Three types of measurement files can be generated.

**Raw files:** Raw files are the actual, untreated data that have been acquired. These are stored on the system's memory.

Raw files measured with positive drift voltage are saved in the format

**YYYYMMdd\_hhmmss.mea.**

Raw files measured with negative drift voltage are saved with the extension NEG in the format **YYYYMMdd\_hhmmss\_NEG.mea.**

**Denoised:** These files are generated from the existing raw files and are only available temporarily. The signal-to-noise ratio is significantly improved by the applied mathematical algorithms. However, these are processed files.

Denoised files are saved with the extension DENOISED or NEG\_DENOISED.

**YYYYMMdd\_hhmmss\_DENOISED.mea.** or

**YYYYMMdd\_hhmmss\_NEG\_DENOISED.mea.**

## 6.7.6 CSV report

Activating **CSV** saves a result file in CSV format to the selected export path in addition to the measurement file. This CSV file is not saved on the device but only on the selected export path.

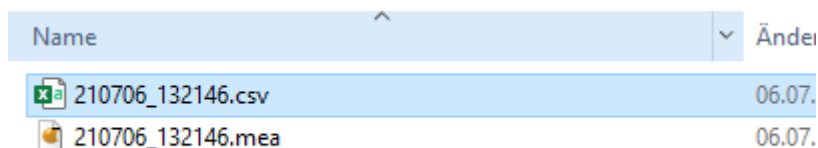



Name	Ände
 210706_132146.csv	06.07.
 210706_132146.mea	06.07.

Figure 66: Example Stored Measurement file and CSV Report file

The following selection window appears, and the export location can be selected.

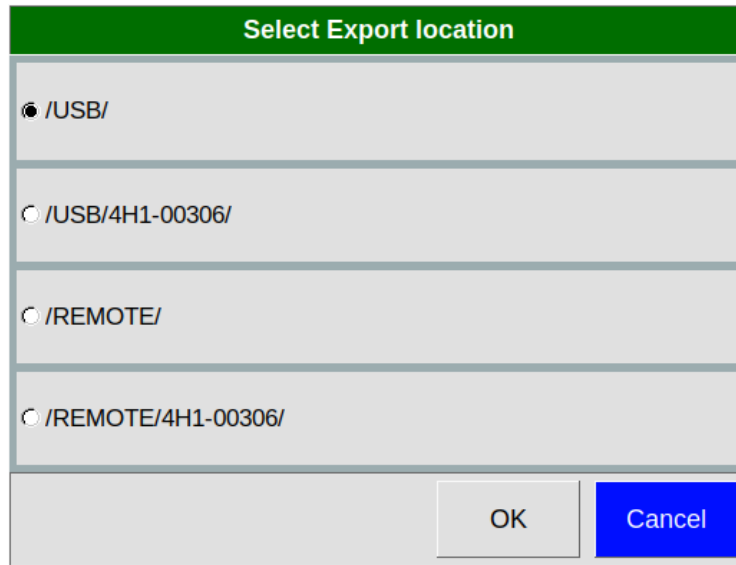

Figure 67: Operating Interface – Export Location Window

By pressing the **OK** button, CSV reports are generated from all internally stored measurement files and saved to the selected export location.



**INFORMATION!**

Exporting as a CSV file is only intended for evaluating substances in the device.

	1	2	3	4	5	6	7	8
1	Measurement file name	Valid	CAS	Substance	Concentration	ConcentrationComment	Unit	Intensity
2	210706_132146.meas	not valid		COS in CO2 new	0	<min 0.000	ppb	0.00000
3								
4								
5								
6								
7								
8								

Figure 68: CSV Report file

<b>1</b>	<b>Measurement file name</b>	The Measurement file name is shown here.
<b>2</b>	<b>Valid</b>	The validity status <b>valid</b> or <b>not valid</b> is shown here.
<b>3</b>	<b>CAS</b>	If the substance name ends with a CAS Registry number (e.g. CAS123-12-1) it is shown here.
<b>4</b>	<b>Substance</b>	An existing substance name without CAS Registry number is shown here.
<b>5</b>	<b>Concentration</b>	The calculated concentration is shown here.
<b>6</b>	<b>ConcentrationComment</b>	Comments are displayed if the measured value is outside the stored calibration range: <b>&lt;min</b> : The value is below the smallest calibration value <b>&gt;max</b> : The value is above the largest calibration value
<b>7</b>	<b>Unit</b>	The unit of the concentration is shown here.
<b>8</b>	<b>Intensity</b>	The absolute signal intensity in Volt is displayed here.

6.7.7 System Modes Window

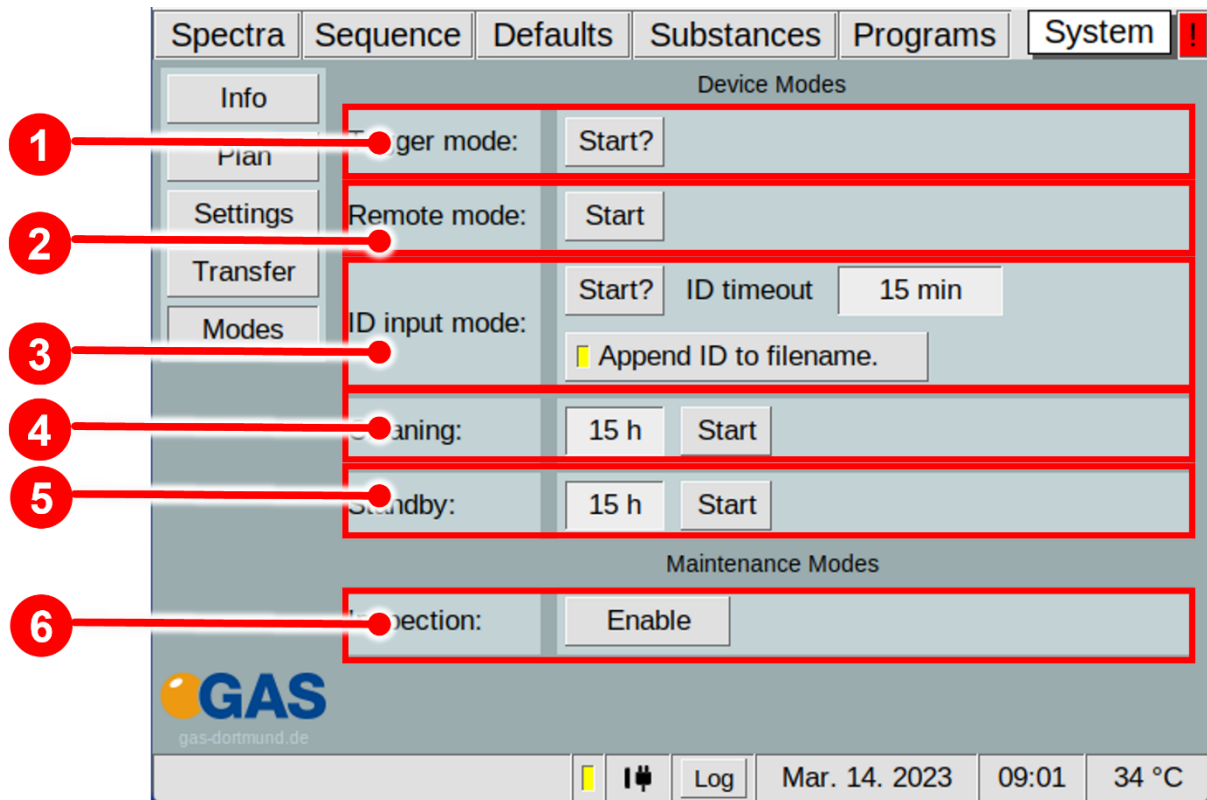

Figure 69: Operating Interface - System Modes Window

1	<b>Trigger mode:</b>	Activate trigger mode with <b>Start</b> .
2	<b>Remote mode:</b>	Activate remote mode with <b>Start</b> .
3	<b>ID input mode (optional)</b>  <b>Only available for device types with EPC_SMP!</b>	<b>Only Breathspect Version 5G2.</b> Allows to enter an identifier in trigger mode. Activate mode with <b>Start</b> . <b>ID timeout</b> sets the validity period time. Activating the <b>Append ID to file in Simplified view</b> Button, stores the entered ID in the metadata of the measurement.
4	<b>Cleaning:</b>	Setup and activate of cleaning mode. With Start-Button the cleaning process is activated and the <b>Cleaning in progress</b> window is displayed. Possible Values: (1-96 hours or infinity) Activate Cleaning Mode with <b>Start</b> .

- 5

**Standby:**

Setup and activate of standby mode. With Start-Button the standby process is activated, and the **Standby Mode** window appears.

Possible Values: (1-96 hours or infinity).  
Activate Standby Mode with **Start**.
  
- 6

**Inspection**

With **Enable**-Button the access to the inspection and diagnostic functions of the device is allowed. This access is password protected.

### 6.7.7.1 Trigger Mode Window

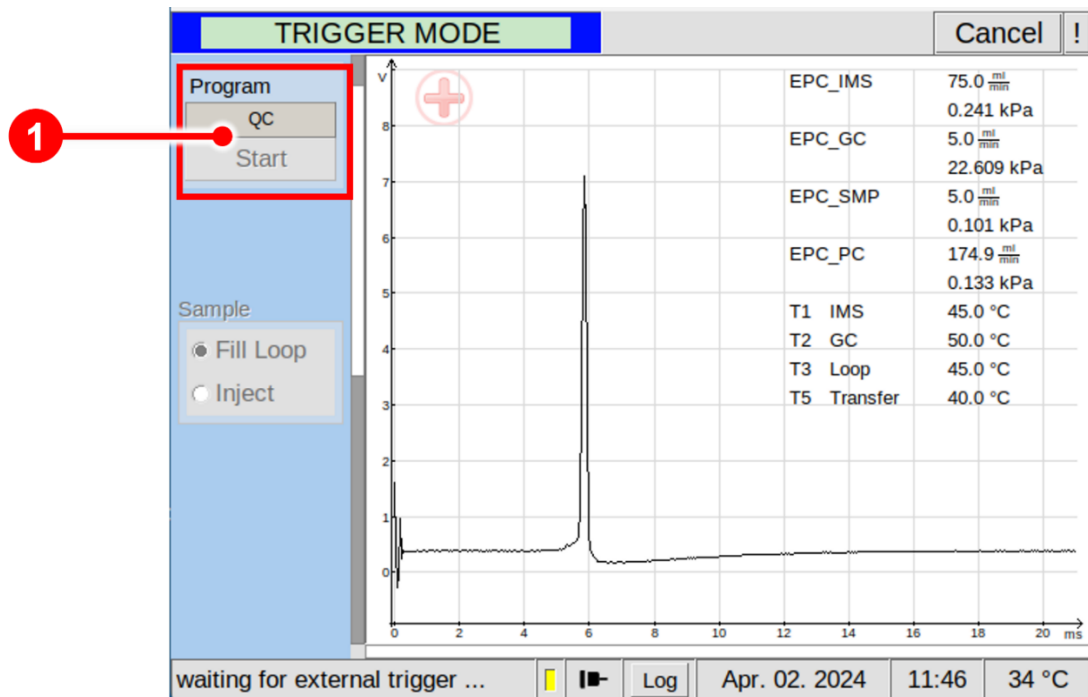

Figure 70: Operating Interface - Trigger Mode Window

- 1

**Program Start Area**

In Trigger mode the displayed program is started by a connected device (e.g.  $\mu$ TD) that operates as master device.

### 6.7.7.2 Remote Mode Window

By activating the Remote Mode, the **Remote Mode** window appears. The window is initially empty. The device is waiting for a sequence file to import.



#### INFORMATION!

The sequence file must be created with the **G.A.S. Sequence Designer Software**. For detailed Information refer to the **G.A.S. Sequence Designer Software Manual**.

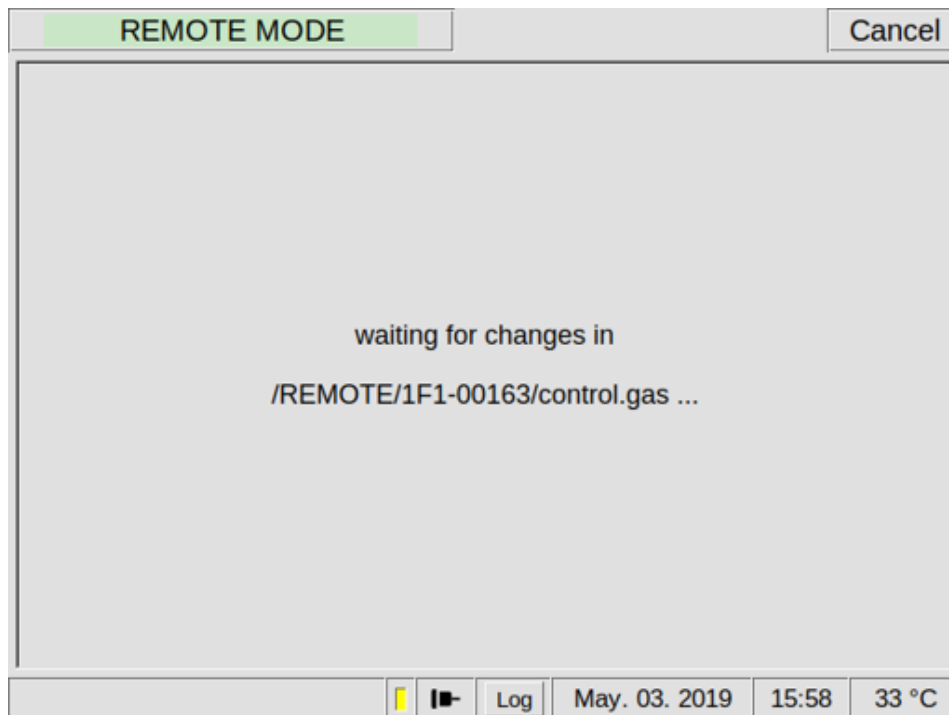

Figure 71: Operating Interface - Remote Mode Window

### 6.7.7.3 ID Input Mode Window



**INFORMATION!**

Only available for device types with EPC\_SMP

By activating the ID Input Mode, the **Remote Mode Window** appears. A measurement identification must be set. The device is waiting for an external trigger signal (e.g. from  $\mu$ TD).

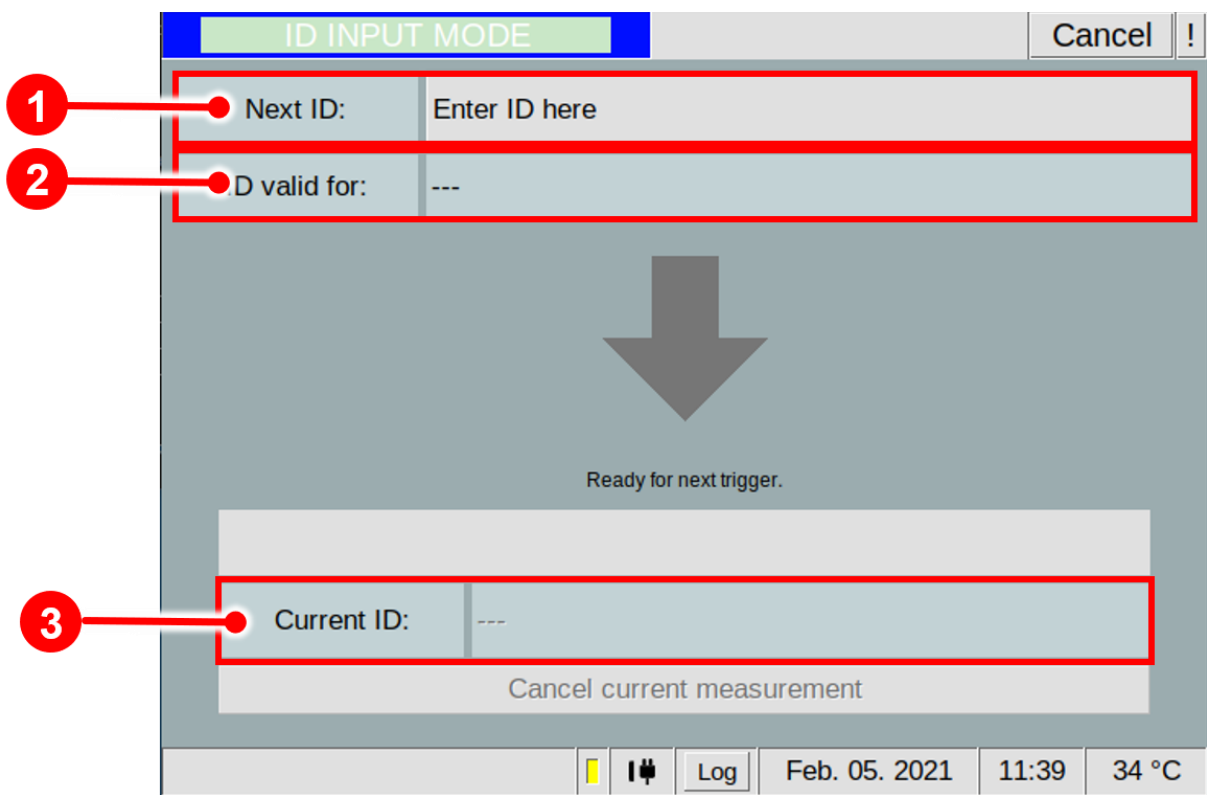

Figure 72: Operating Interface - Simplified View Window

<b>1</b>	<b>Next ID:</b>	A measurement identification must be set.
<b>2</b>	<b>ID valid for:</b>	The set validity period is displayed
<b>3</b>	<b>Current ID:</b>	The current ID is displayed for the current measurement.

### 6.7.7.4 Cleaning Mode Window

By activating the Cleaning Mode, the **Cleaning in progress** window appears. The high voltage is switched off but can be switched on by clicking **HV-On** temporarily for control purposes. During the cleaning process the available system temperatures (T1-T6) are heated up to their maxima. The default flow rate settings applied by the operator for Driftgas (E\_IMS), Carriergas (E\_GC) and optionally Sample gas (E\_SMP) setup in Defaults window are used. After the setup time has expired the cleaning process is terminated.

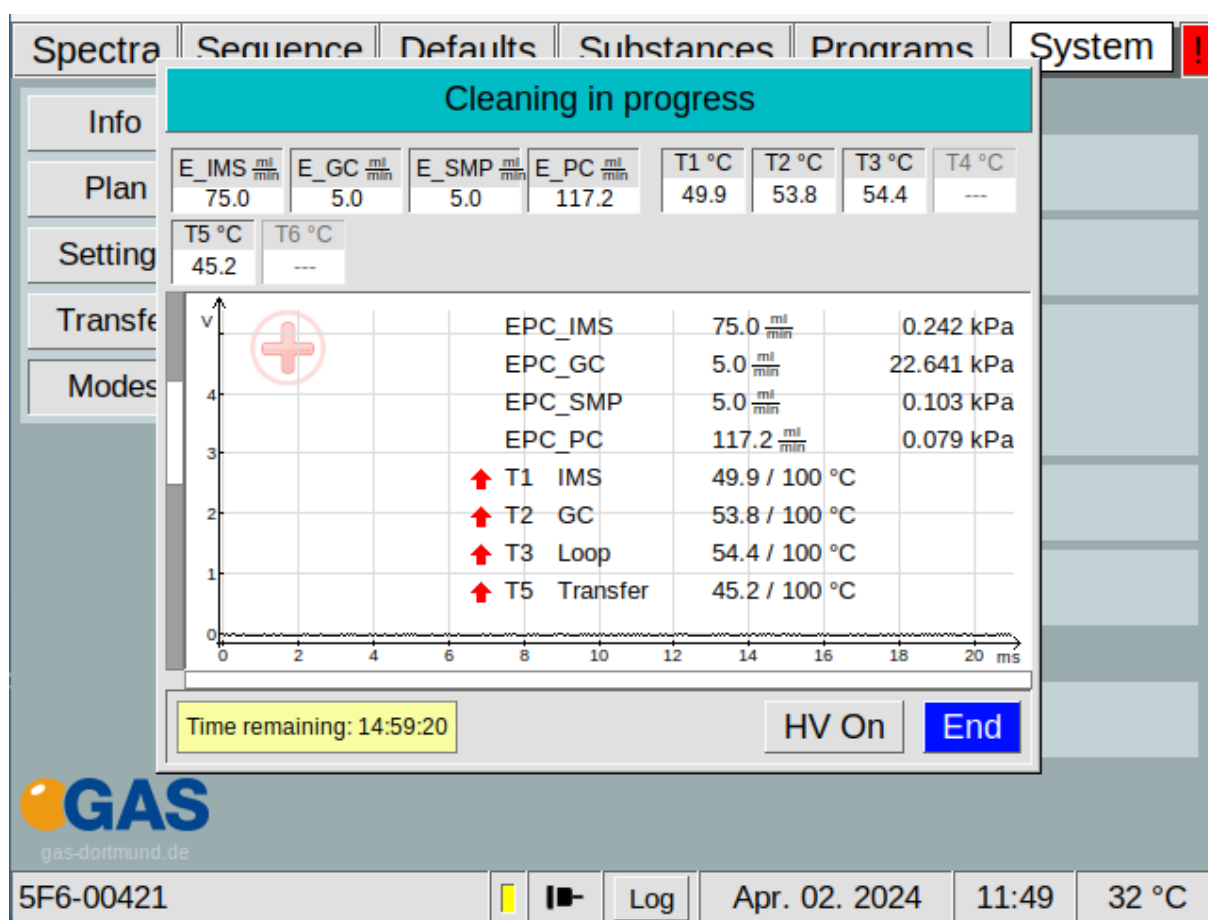

Figure 73: Operating Interface - Cleaning Mode Window



#### INFORMATION!

During the cleaning process the available heated device component temperatures (T1-T6) are set to their maxima. Values of more than 80°C are displayed as >80°C.

### 6.7.7.5 Standby Mode Window

By activating the Standby Mode, the **Standby Mode** window appears. The flowrate of the Drift gas (EPC\_IMS) and the carrier gas (EPC\_GC) will be decreased to reduce gas consumption. The **standby mode flowrate** for drift gas **(E\_IMS) is 10 ml/min**, for carrier gas **(E\_GC) is 5 ml/min** and optionally for sample gas **E\_SMP is 5 ml/min**

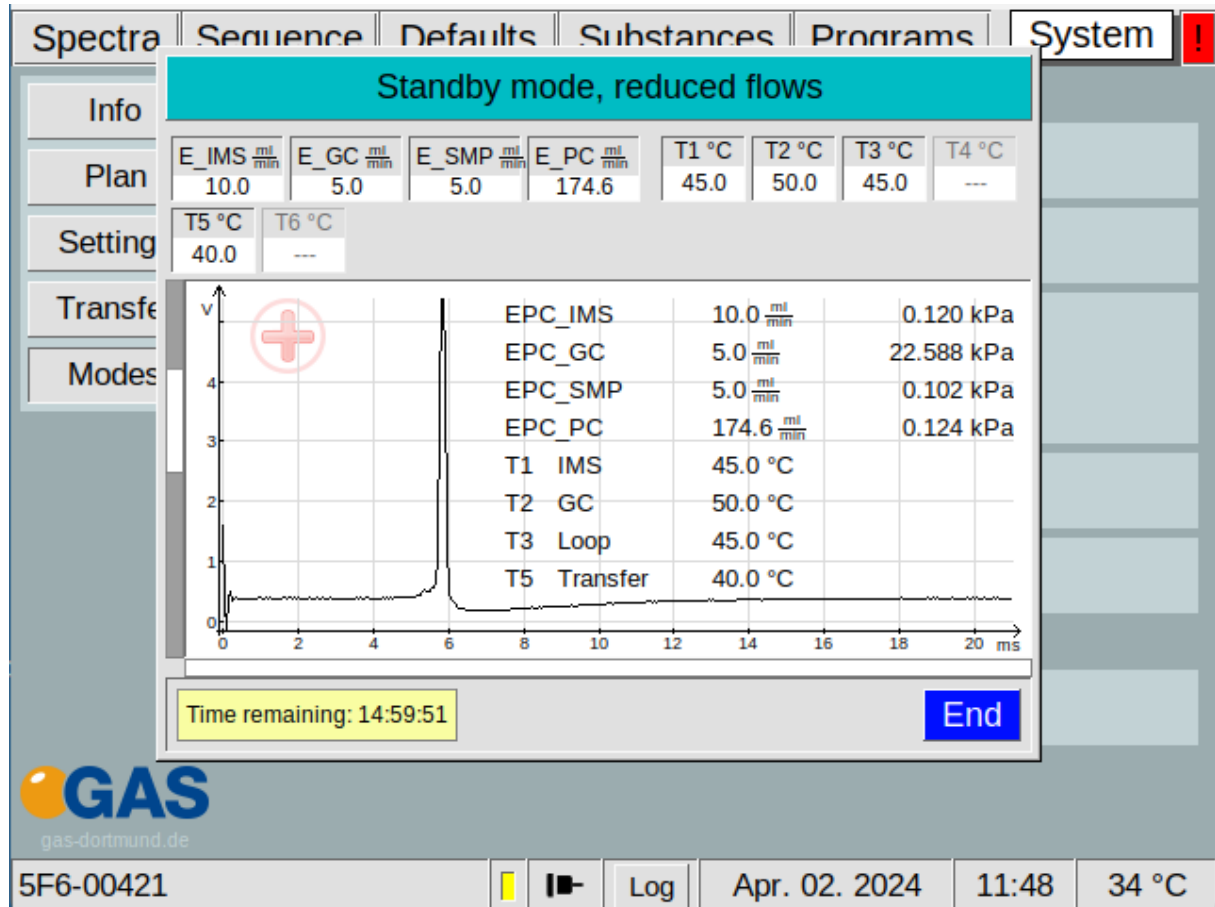

Figure 74: Operating Interface - Standby Mode Window

## 6.8 Error Information Window

In case if an Error is occurring the **!-Tab** is blinking red. The error window shows an overview of the current error events. When the device is restarted, the error events are deleted.

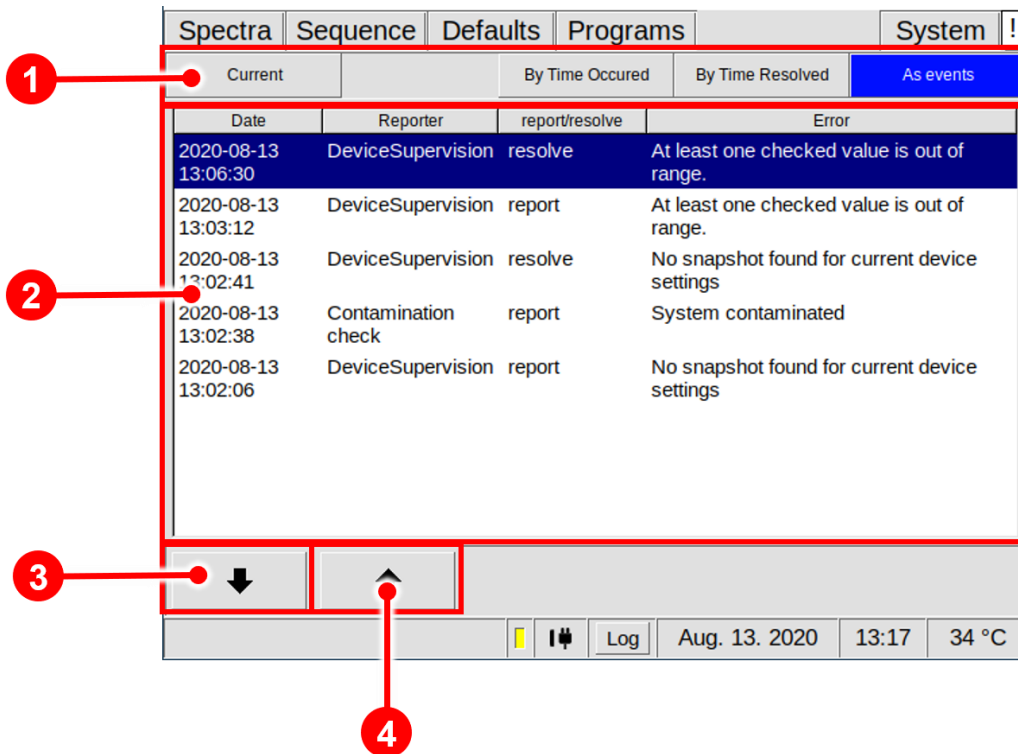

Figure 75: Error Information Window

<b>1</b>	<b>Selection Sort Order Bar</b>	Selects the following sort order: <b>Current</b> ; <b>By Time Occurred</b> ; <b>By Time Resolved</b> ; <b>As Event</b>
<b>2</b>	<b>Entry List</b>	A list of system event messages. The display depends on the selected sort order
<b>3</b>	<b>Down Button</b>	Scrolls one message down.
<b>4</b>	<b>Up Button</b>	Scrolls one message up.

## 6.9 Additional Dialogue Windows

### 6.9.1 Log Messages Window

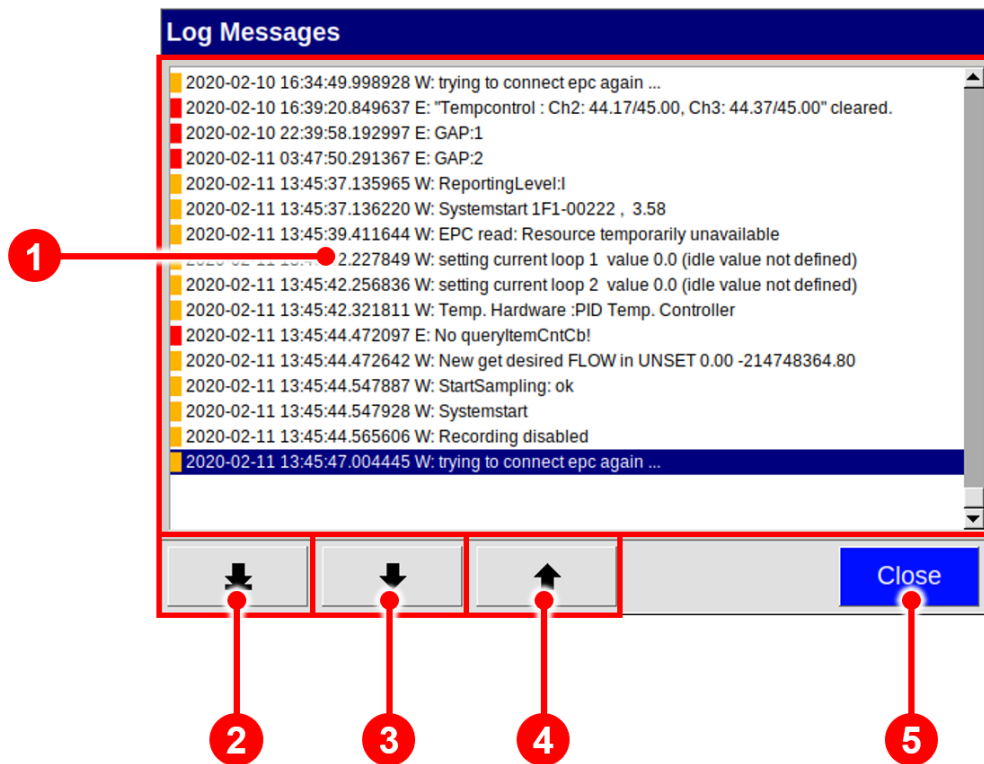

Figure 76: Log Messages Window

<b>1</b>	<b>Entry List</b>	A chronological list of system event messages. Warnings are marked orange, error messages are marked red.
<b>2</b>	<b>To Last Entry Button</b>	Scrolls down to the latest entry.
<b>3</b>	<b>Page Down Button</b>	Scrolls one page down.
<b>4</b>	<b>Page Up Button</b>	Scrolls one page up.
<b>5</b>	<b>Close Button</b>	Closes the dialog.

### 6.9.2 IP Address Input Dialog Windows

The IP Address Input Dialog is used to edit the static IP address of the device and the IP address of a remote server. This is necessary when configuring the LAN file transfer.

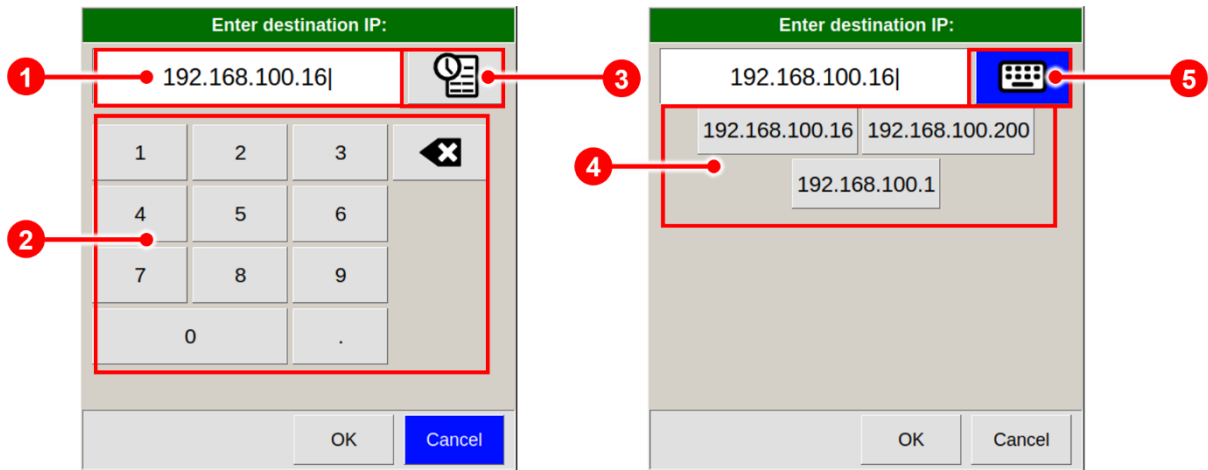

Figure 77: IP Address Input Dialog Windows

1	<b>IP Address Field</b>	The current IP address.
2	<b>Digit and Dot Buttons / Backspace Button</b>	Use these buttons to enter an IP address.
3	<b>History Button</b>	Displays a menu of previously used IP addresses to choose from.
4	<b>History Entry Buttons</b>	Buttons for entering previously used IP addresses.
5	<b>Keyboard Button</b>	Displays the keyboard.

### 6.9.3 Date and Time Input Dialog Window

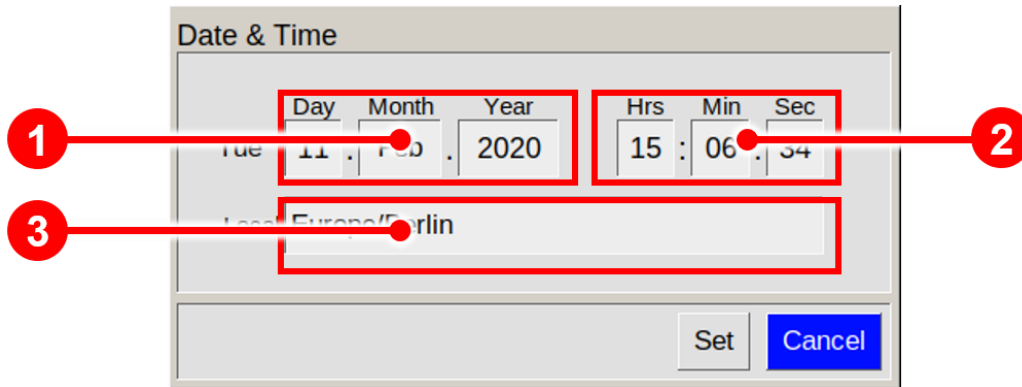

Figure 78: Date and Time Input Dialog Window

<b>1</b>	<b>Date Fields</b>	Fields displaying and modifying day, month and year.
<b>2</b>	<b>Time Fields</b>	Fields displaying and modifying hours, minutes and seconds.
<b>3</b>	<b>Timezone</b>	Field for selection of timezone.

### 6.9.4 Text Input Dialog Window

The Text Input Dialog is used to enter identifiers, e.g. shared folder name.

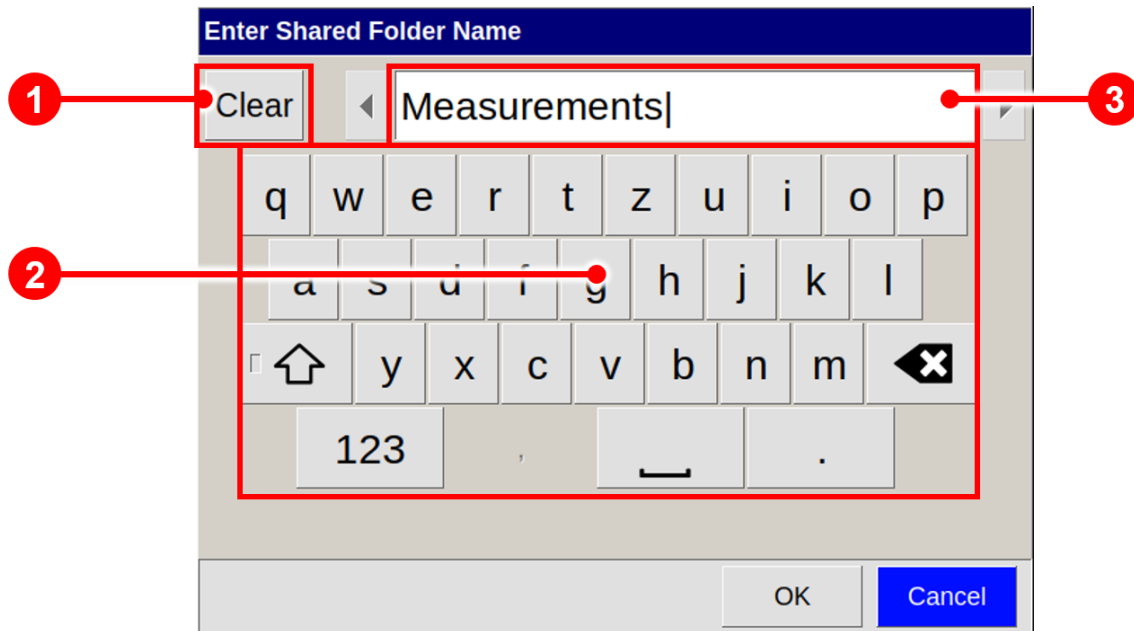

Figure 79: Text Input Dialog Window

1	<b>Clear Button</b>	Deletes the text in the current text field
2	<b>Keyboard Buttons</b>	Character and control buttons for entering a text. Depending on the context some buttons are disabled.
3	<b>Current Text Field</b>	The editable text.

### 6.9.5 Number Input Dialog Window

The Number Input Dialog is used in Program Window to enter number values, e.g. Start time, Flow Rates and Pump Power setpoints in Program Actions.

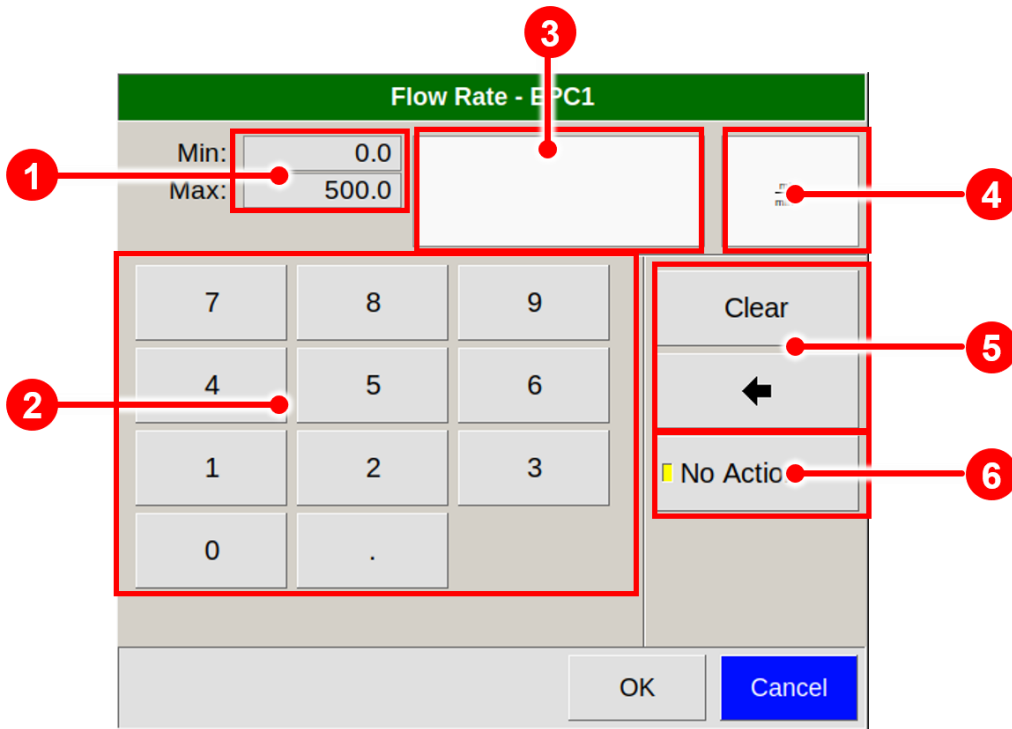

Figure 80: Number Input Dialog Window (Example)

<b>1</b>	<b>Range / Raster Info</b>	Displays the valid value range.
<b>2</b>	<b>Keyboard Buttons</b>	Buttons for entering a number.
<b>3</b>	<b>Value Field</b>	The entered numerical or selected special value.
<b>4</b>	<b>Unit</b>	Value unit name.
<b>5</b>	<b>Clear and Backspace Button</b>	Buttons for clearing the input field or deleting the last digit.
<b>6</b>	<b>Dedicated Values Buttons</b>	Dedicated value like <b>No Action</b> (only if available)

## 7 Installation BreathSpec® Device with Ciruclar Gas Flow Unit

### 7.1 Installation Requirements

The following requirements must be fulfilled by the customer:

#### Location of Installation

- Available space of 600 x 700 x 300 mm (W x D x H)
- Ambient temperature of 5 – 40°C
- Humidity: 0-90% RH, non-condensing

#### Electricity

- Electricity supply free of interferences
- Power Supply of 230 V  $\pm$  10%, 50- 60 Hz  $\pm$  1%

#### Safety

- Availability of exhaust system for device exhaust gas tube (Sample Gas out)

#### Computer

- Computer with current Microsoft Windows operating system
- Administrator right to install G.A.S. software



#### INFORMATION!

To ensure correct measurements it is necessary to **connect the supplied exhaust tube** (Sample gas out).

The exhaust tubes (Gas out and Sample gas out) **must be led separately into the exhaust system and must not be connected.**

The exhaust system must **not generate any negative pressure.**

## 7.2 Installing the device

1

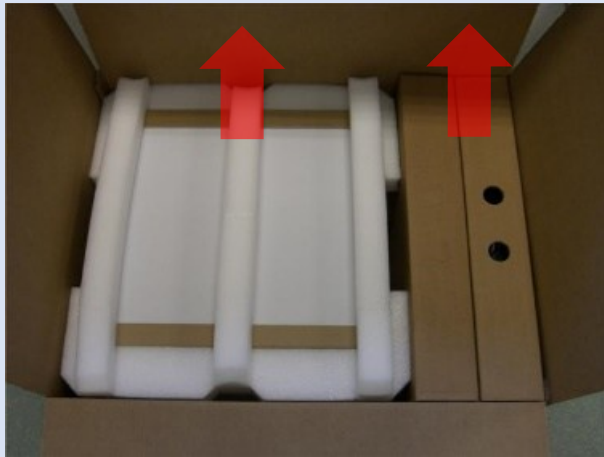

Unpack the device.

Remove the foam spacers.

Remove the accessories boxes.

Lift the device from the transport box.



### WARNING!

Do not deploy the device in areas exposed to explosive substances or mixtures!

2

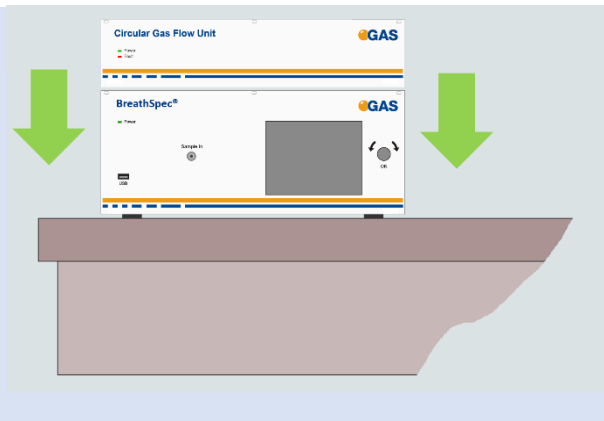

Place it on a robust tabletop of minimum footprint size of 60 cm x 70 cm. Ensure that there is enough working space at the rear side of the device.

3

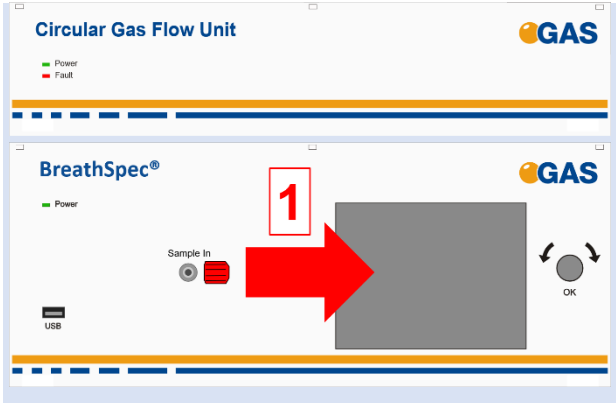

**Remove red protective cap** from gas sockets at front of housing. Retain for future use.

4

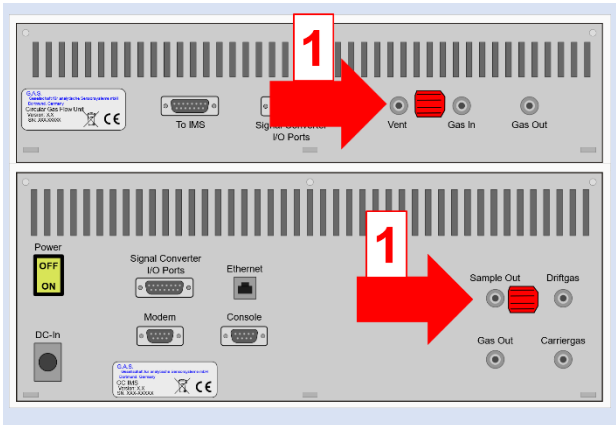

**Remove red protective caps** from gas socket at rear of housing. Retain for future use.



**INFORMATION!**

Protective caps should be put on gas sockets in case the device is stored or transported.



**WARNING!**

It is absolutely necessary to **remove all protective caps before the system is switched on.**



**INFORMATION!**

**Gas tubes** and **GCFU Connection Cable** are **preinstalled.**

5

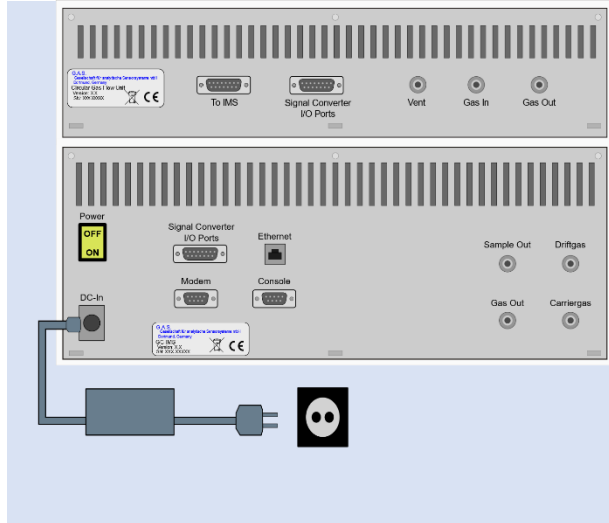

Connect device to power supply.

Connect power supply to power socket.

6

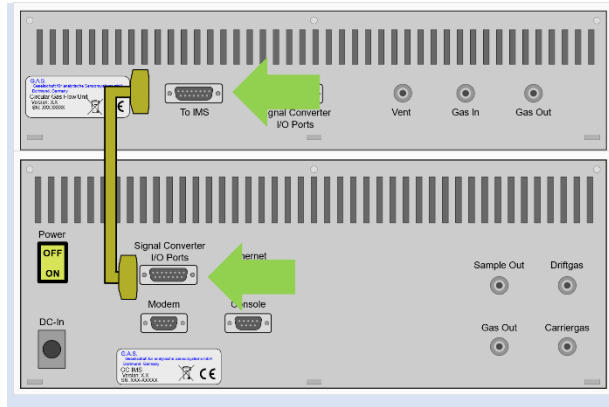

Connect CGFU-Connection-Cable.

(normally pre-installed!)

7

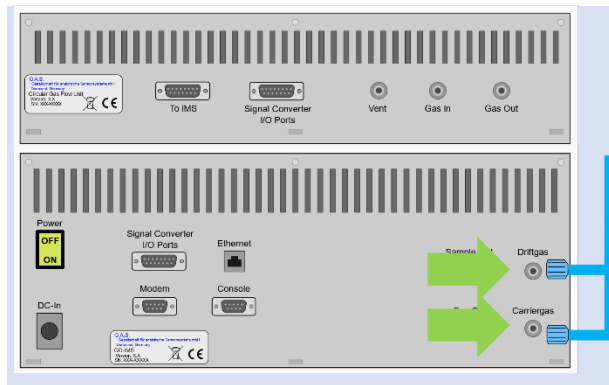

Connect the **Driftgas-/Carriergas-Adapter** to the **Driftgas-** and the **Carriergas-Connector**.

(normally pre-installed!)

8

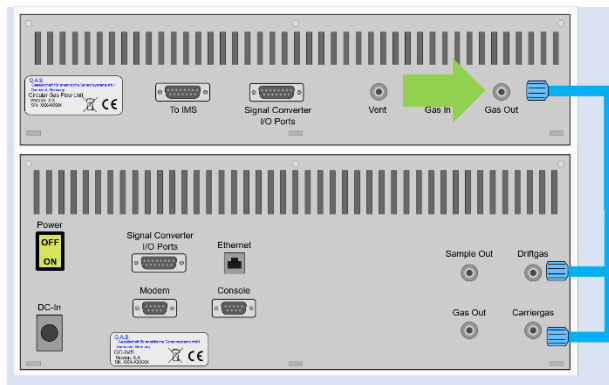

Connect CGFU **Gas Out** outlet to **Driftgas-/Carriergas-Adapter** using a PFA tube.

(normally pre-installed!)

9

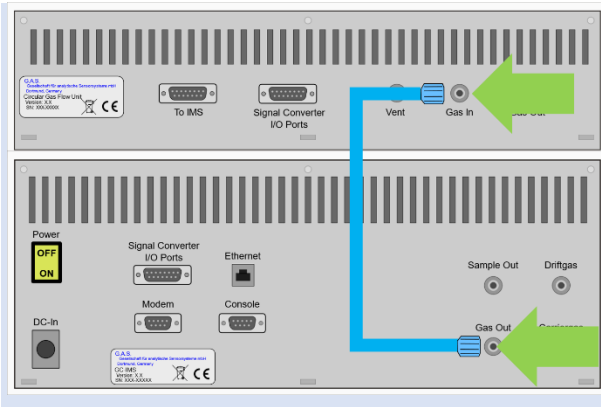

Connect CGFU **Gas In** inlet to GC-IMS **Gas Out** outlet using a PFA tube. (normally pre-installed!)

10

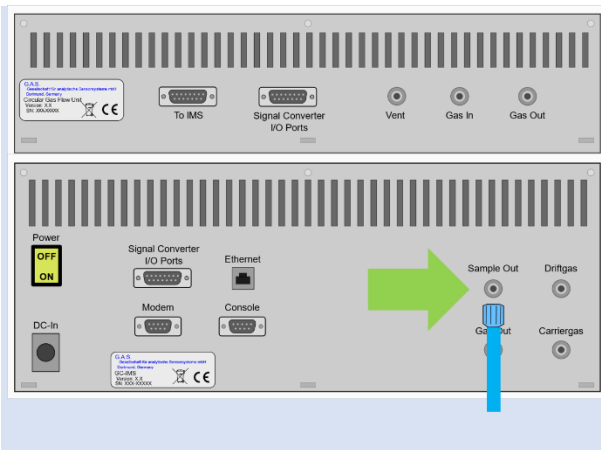

Connect **Sample Out** to an appropriate waste gas ventilation system.



**INFORMATION!**

To ensure correct measurements it is absolutely necessary to **connect the supplied exhaust tube** (Sample out).

The exhaust system must **not generate any negative pressure**.

11

Connect the Sampling System:

- Mouthpiece tube with heated Transfer Line **see chapter 7.4**
- Heated Luer-Lock-Adapter **see chapter 7.5**

12

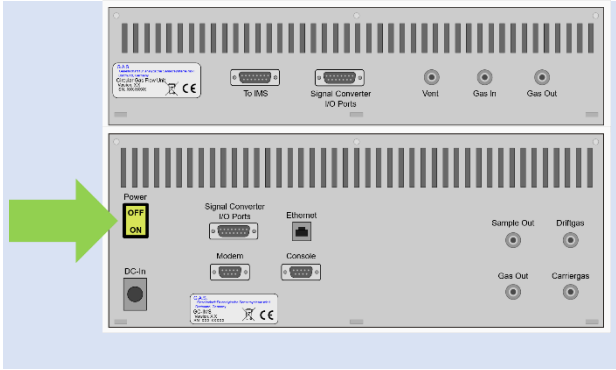

Switch on device.

13  
Option

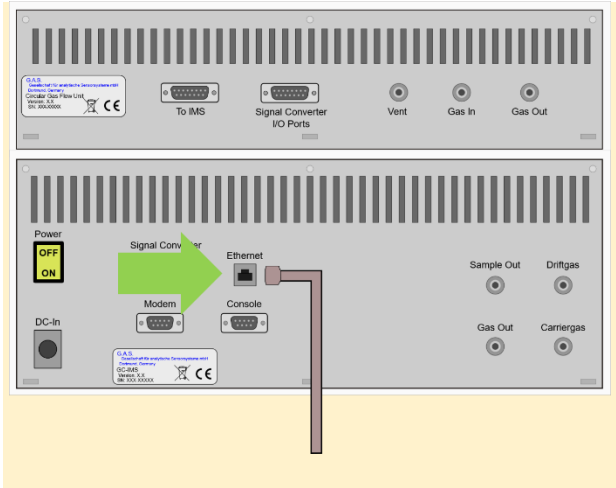



For file transfer via LAN:  
Connect the **Ethernet** socket with an appropriate Ethernet cable to a LAN.



**INFORMATION!**

When using a CGFU unit the total flow (EPC\_IMS and EPC\_GC) is limited to 400 ml/min.

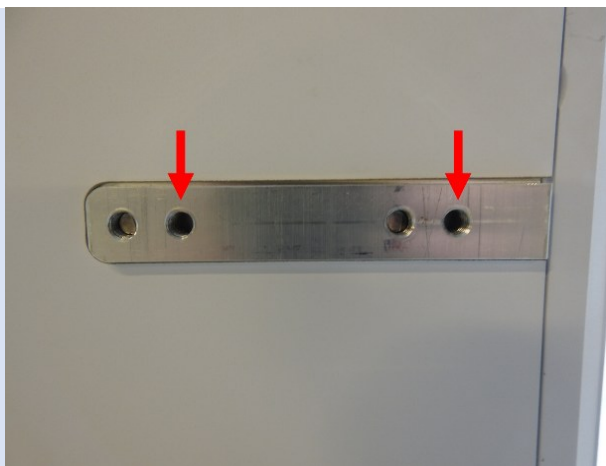
### 7.3 Mounting the Mouthpiece holder

<p><b>1</b></p>	 A photograph of a silver metal L-shaped arm with a blue plastic handle. A small clear plastic bag containing screws is placed next to the arm on a light-colored surface.	<p>Mouthpiece-Handheld holder arm with screws</p>
<p><b>2</b></p>	 A close-up photograph of the silver metal arm. Two red arrows point to two circular holes on the horizontal section of the arm, indicating the mounting points.	<p>For mounting the arm use the marked holes.</p>
<p><b>3</b></p>	 A photograph showing the silver metal arm being mounted onto a white surface. A silver Torx screwdriver is being used to tighten a screw into one of the holes.	<p>Mount the arm with a Torx screwdriver T30.</p>

### 7.4 Connecting the Mouthpiece tube

**1**



Mouthpiece Handheld with heatable Transfer-line

**2**

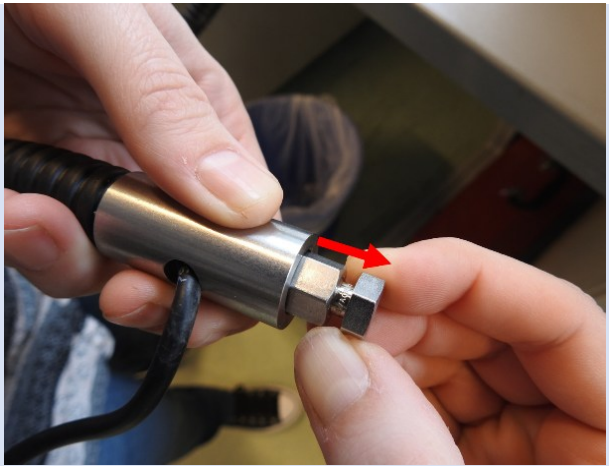

Pull the screw upwards.

**3**



Remove the handling screw.

4



Connect the Transfer Line to the sample-in connector.

Screenshots 4 – 9  
ersetzen

5



Tighten the screw with a spanner.

6



Connect the current supply cable.

7



Tighten the current supply cable.

8

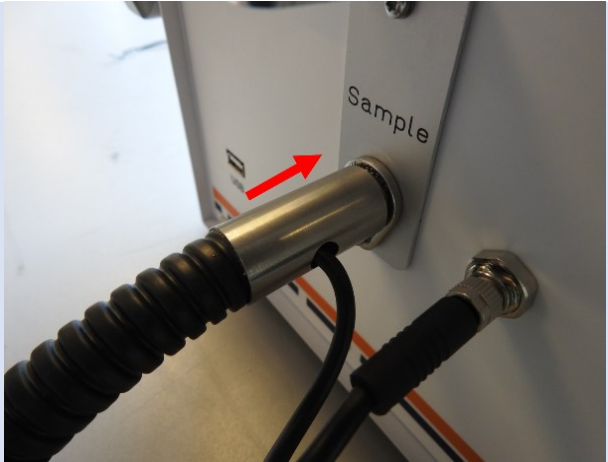

Push the Transfer-line connector onto the **Sample In connector**.

9



Place the Mouthpiece handheld into the handheld holder.

10



Switch ON the  
BreathSpec.

## 7.5 Warm-up phase after device switch-on

After switching on, the device is in the warm-up phase. The warm-up phase serves to protect the system against potential electronic damage which can be caused by condensation of humidity occurring during longer switch-off phases, e.g. after transportation or storage.

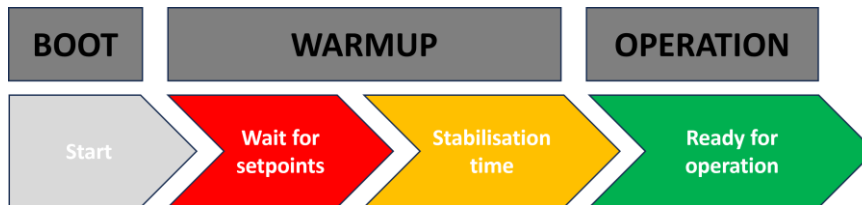

The warm-up phase is divided into two sub-phases:

### Phase 1: Waiting for setpoints

All set temperatures must be reached and stable for 30 seconds before switching to phase 2.

### Phase 2: Stabilization time

When all temperatures are stable, it takes up to one hour until the system is ready for operation.

The maximum duration of the warm-up phase is limited to 2 hours. The system's high voltage is switched off during this time.



#### INFORMATION!

The warm-up phase can be interrupted at any time by the user at his own risk.

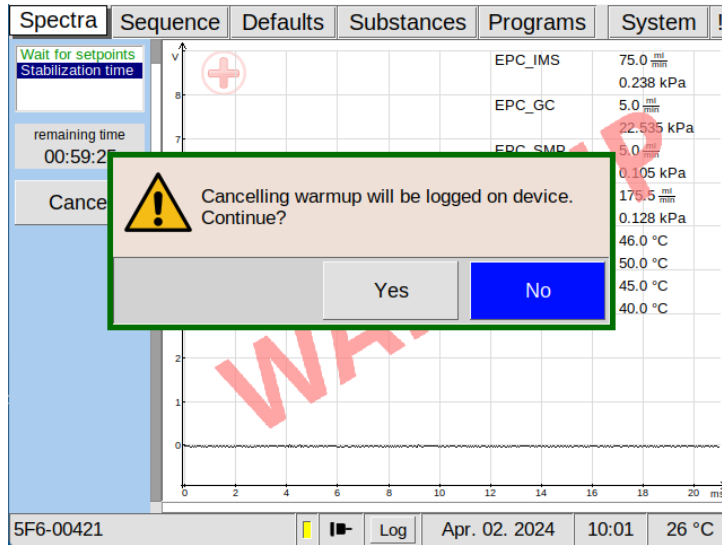

Figure 81: Warm-up Cancelling Window

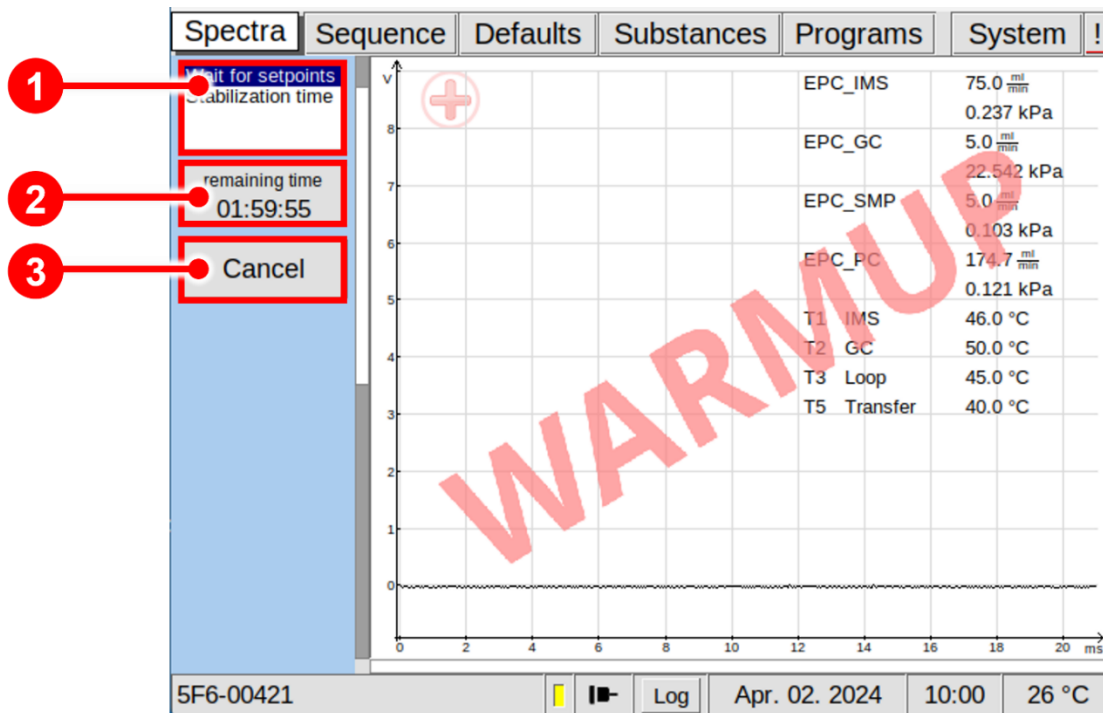

Figure 82: Spectra Window during the Warm-up Phase

<b>1</b>	<b>Warm-up Status Window</b>	Displays the current status of the warm-up phase: <b>Phase 1: Waiting for setpoints</b> <b>Phase 2: Stabilization time</b>
----------	------------------------------	--

<b>2</b>	<b>Warm-up Remaining Time Window</b>	Shows the remaining time of the warm-up phase
<b>3</b>	<b>Warm-up Cancel Button</b>	The user can cancel the warm-up process with this button.

## 7.6 Prepare the device for operation

Before using the device for the first time or after being disconnected from the nitrogen source for some time it must be cleaned to ensure proper operating conditions. In this case start the **Cleaning mode**.

An appropriate cleaning period duration must be chosen depending on how long the device was switched off and on the extent of contamination. It is recommended to clean the device for at least **15 hours** before operating it for the first time. If the Spectrum is not clean repeat the process. A **reference spectrum** for the evaluation can be found in the supplied **Analytical Approval**.



### INFORMATION!

After the cleaning process the device needs at least **2 hours** to cool down the internal components to their required temperatures.

The duration of the cool down process is depending on the temperature default settings.



### INFORMATION!

If the BreathSpec is turned off, wait a minimum of 10 minutes before restarting as otherwise the CGFU pump will not start due to overpressure within the system.

1

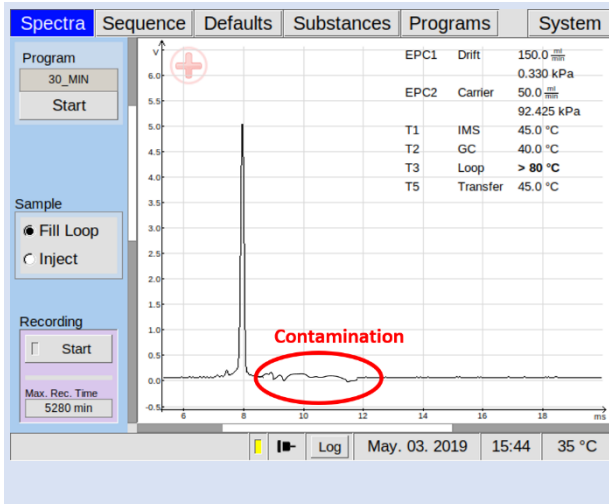

Inspect spectrum for contamination. Control the baseline. Start cleaning when contaminated. Contamination is indicated by peaks or the disappearing of the RIP.

2  
Option

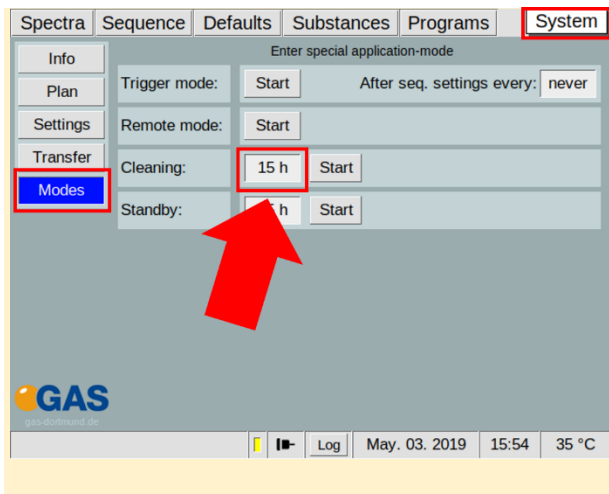

Select duration in hours:  
**System** > **Modes** >  
**Cleaning Mode** > **x h**

3  
Option

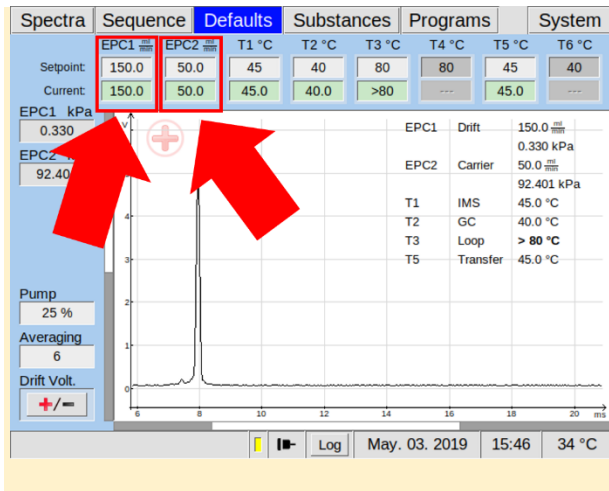

To speed up this process, increase flow rate of EPC\_IMS and EPC\_GC to their maximum values (e.g 500/150 ml/min):  
**Defaults** > **EPC\_IMS** >  
**EPC\_GC**

4

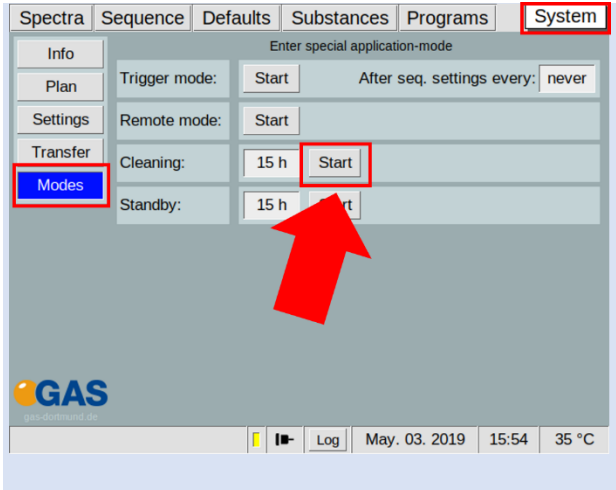

Start cleaning:

**System** > **Modes** >  
**Cleaning Mode** > **Start**

5

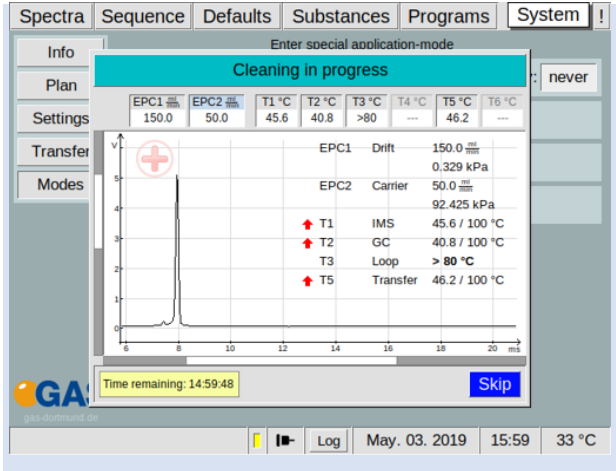

Wait until cleaning process is completed.  
 The process can be stopped with **Skip**.

## 6

**Spectra** Sequence Defaults Substances Programs System

Program: 30\_MIN Start

Sample:  Fill Loop  Inject

Recording: Start Max. Rec. Time: 5280 min

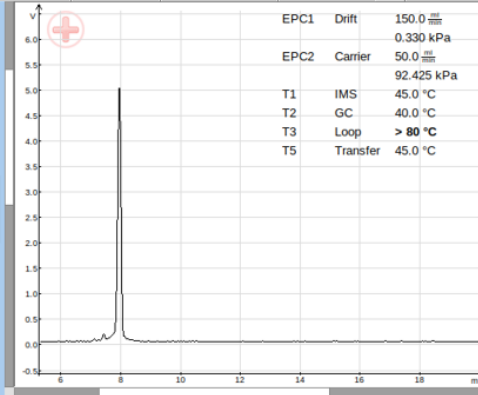

EPC1	Drift	150.0 $\frac{mV}{min}$
		0.330 kPa
EPC2	Carrier	50.0 $\frac{mV}{min}$
		92.425 kPa
T1	IMS	45.0 °C
T2	GC	40.0 °C
T3	Loop	> 80 °C
T5	Transfer	45.0 °C

Log May. 03. 2019 15:44 35 °C

### Analytical Approval

**GAS**

Type:	BreathSpec® + $\mu$ -TD
Serial number:	5G2-00450
Working principle:	Ion Mobility Spectrometry (IMS)
Ionisation:	$\beta$ -radiation source (Tritium ( $^3H$ ))
Sensor number:	00060120
Column type:	MXT-WAX, 30 m L, 0.53 mm ID, 0.5 $\mu$ m FT
Firmware Version:	4.14
Year of construction:	2023
$\mu$ -TD Serial Number:	

Measurement conditions			
Drift gas flow rate:	75 mL/min	Carrier gas flow rate:	5-50 mL/min
Drift gas type:	Nitrogen 5.0	Carrier gas type:	Nitrogen 5.0
Drift gas pressure:	0,150 kPa	Carrier gas pressure:	22,122 kPa
IMS temperature (T1):	45 °C	Column temperature (T2):	40 °C
Loop temperature (T3):	45 °C	Transferline temperature (T5):	40 °C
Valve opening time:	6 sec	Averages:	6
Trigger duration:	100 $\mu$ s	RIP voltage:	positive
Testmix/ Calibration sample:	Testmix_HS6_M3	Concentration range:	162-164 ppb
Sample-Test gas flow rate (Pump 30%):	~171 mL/min	Measurement runtime:	30 min
Program:	QC	Date of measurement:	04.08.2023

RIP (4,43 ms, 7,32 V)

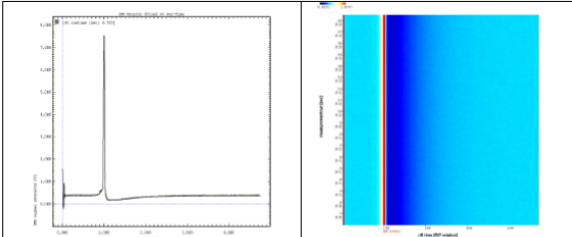

After all temperatures have reached the default values inspect visually the current spectrum and compare it with the reference spectrum of the analytical approval. **The RIP should reach ~80% of the RIP height displayed in the delivered Analytical Approval of the device when the same measurement conditions are used (as applied at G.A.S.) The assessment of the readiness to measure is additionally supported by the system.**

If not check the gas quality and/or install additional purification cartridges and start the cleaning procedure again.

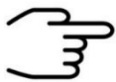

### INFORMATION!

The device is delivered with an acceptance snapshot. This snapshot defines the system performance during device acceptance and is used to assess the readiness for measurement. Any deviations from this are displayed in the Error Information Window. **The default values can be adjusted by the customer.**



**INFORMATION!**

The system in combination with CGFU is preset with the gas type Air for drift gas and carrier gas. Normally, nitrogen or synthetic air in quality 5.0 is used. **The default values can be adjusted by the customer.**

## 8 Installation BreathSpec® Device with Airsense µTD

### 8.1 Installation Requirements

The following requirements must be fulfilled by the customer:

#### Location of Installation

- Available space of 600 x 700 x 300 mm (W x D x H)
- Ambient temperature of 5 – 40°C
- Humidity: 0-90% RH, non-condensing

#### Electricity

- Electricity supply free of interferences
- Power Supply of 230 V  $\pm$  10%, 50- 60 Hz  $\pm$  1%

#### Gas supply

- Nitrogen (Quality 5.0 (99,999%) or Synthetic Air (Quality 5.0 (99,999%))
- Stainless steel pressure reducer adjustable, adjustable pressure range of 3 – 6 bar and 3 mm Swagelok connector

#### Safety

- Availability of exhaust system for device exhaust gas tubes (Gas out and Sample Gas out)

#### Computer

- Computer with current Microsoft Windows operating system
- Administrator right to install G.A.S. software



**INFORMATION!**

To ensure correct measurements it is absolutely necessary to **connect the supplied exhaust tubes** (Gas out and Sample gas out).

The exhaust tubes (Gas out and Sample gas out) **must be led separately into the exhaust system and must not be connected**.

The exhaust system must **not generate any negative pressure**.

## 8.2 Installing the device

**1**

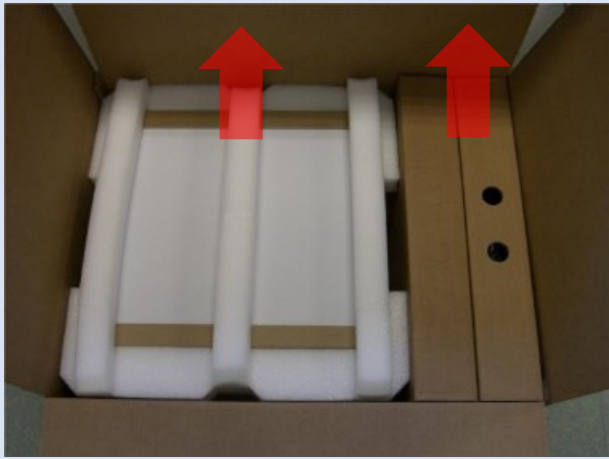

Unpack the device.

Remove the foam spacers.

Remove the accessories boxes.

Lift the device from the transport box.



**WARNING!**

Do not deploy the device in areas exposed to explosive substances or mixtures!

**2**

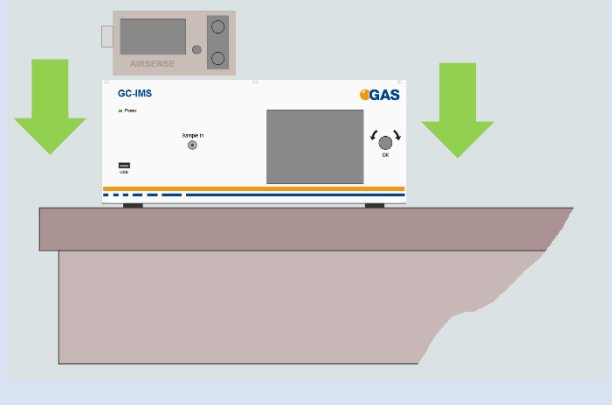

Place it on a robust table top of minimum footprint size of 60 cm x 70 cm. Ensure that there is enough working space at the rear side of the device.

**3**

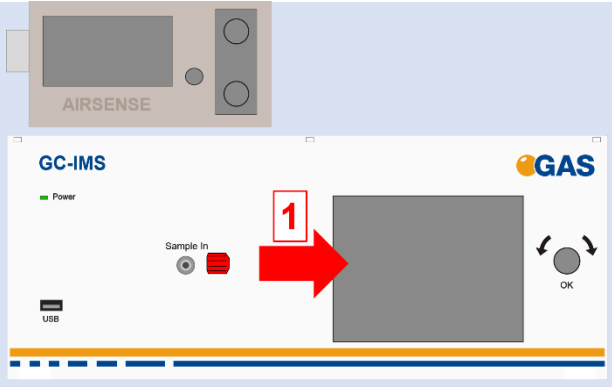

Remove red protective caps from gas sockets at front of housing. Retain for future use.

**4**

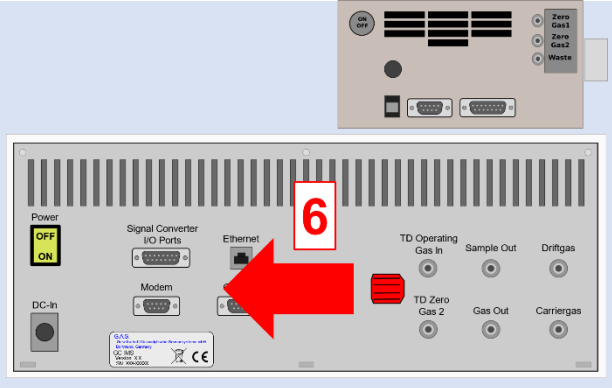

Remove red protective caps from gas socket at rear of housing. Retain for future use.

**5**

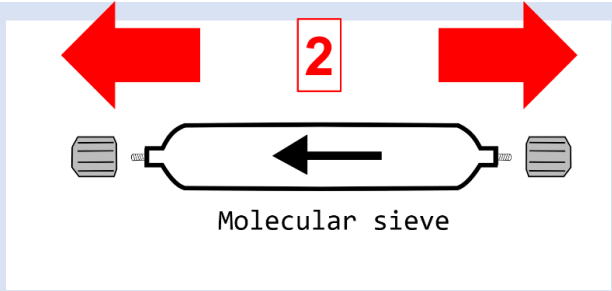

Remove protective caps from molecular sieve. Retain for future use.



**INFORMATION!**

Protective caps should be put on gas sockets in case the device is stored or transported.



**WARNING!**

It is absolutely necessary to **remove all protective caps before the system is switched on.**



**INFORMATION!**

Make sure that the power switch is set to OFF before connecting the power supply.

6

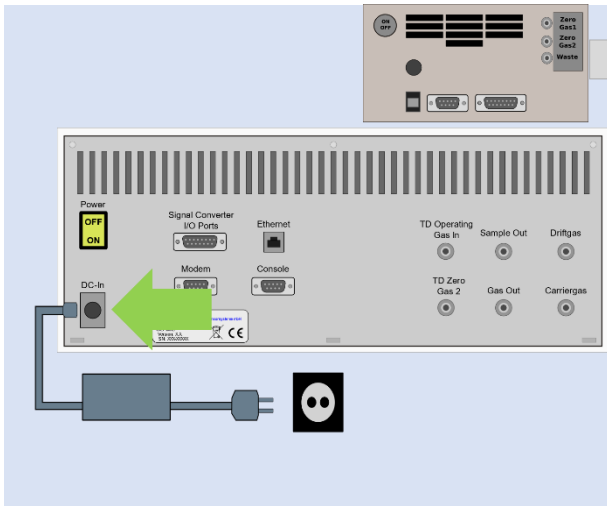

Connect BreathSpec device to power supply.

Connect power supply to power socket.

7

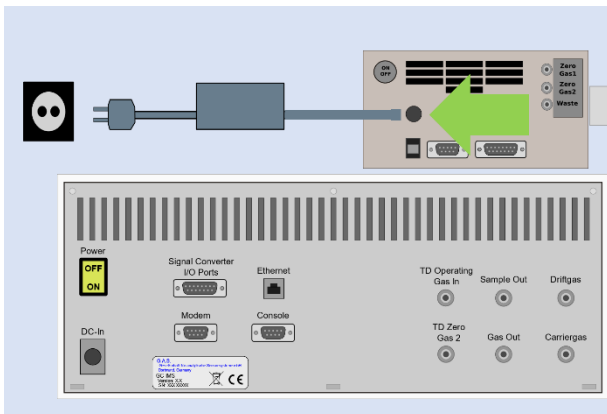

Connect  $\mu$ TD device to power supply.

Connect power supply to power socket.



**INFORMATION!**

Only use **stainless steel pressure reducers**, **PFA tubes** with 3 mm outer diameter and **3 mm Swagelok** connectors.

Screw on the Swagelok caps manually and fix them by screwing a further half-turn using a 12 mm open-end wrench.



**WARNING!**

Do not introduce aggressive gases or liquids into the device.

8

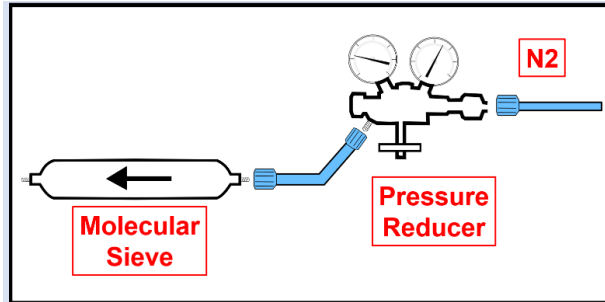

Connect nitrogen gas (Purity 5.0 or better) source to input of supplied molecular sieve using a PFA tube.

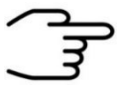

**INFORMATION!**

Recommended pressure of **Operation Gas** (Driftgas / Carriergas) is **3 bar (300 kPa)**. 6 bar (600 kPa) must not be exceeded.

8

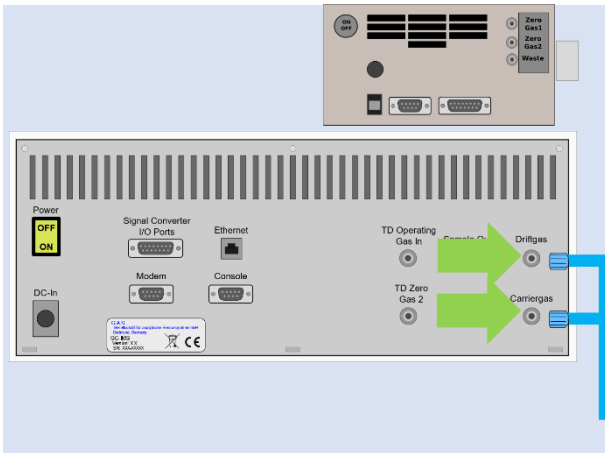

Connect the Driftgas-/Carriergas-Adapter to the Driftgas- and the Carriergas-Connector.

9

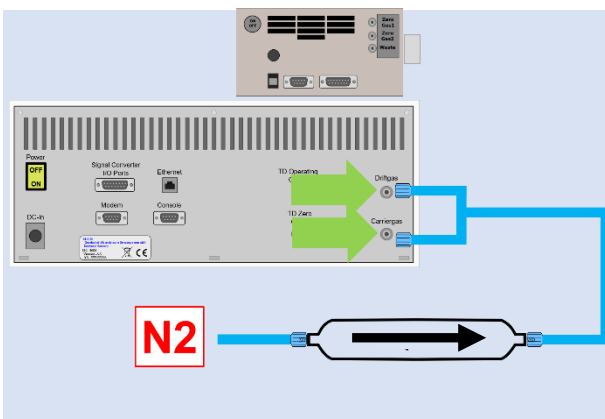

Connect molecular sieve outlet to **Driftgas-/Carriergas-Adapter** using a PFA tube.

10

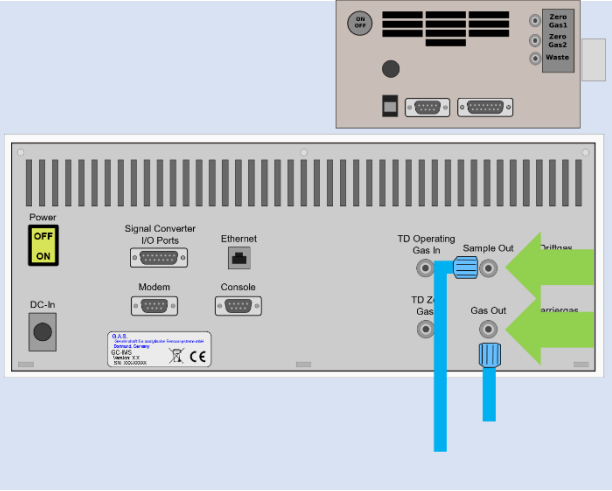

Separately connect sockets **Sample Out** and **Gas Out** to appropriate waste gas ventilation system.

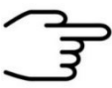

**INFORMATION!**  
 To ensure correct measurements it is necessary to **connect the supplied exhaust tubes** (Gas out and Sample gas out).  
 The exhaust tubes (Gas out and Sample gas out) **must be led separately into the exhaust system and must not be connected.**  
 The exhaust system must **not generate any negative pressure.**

11

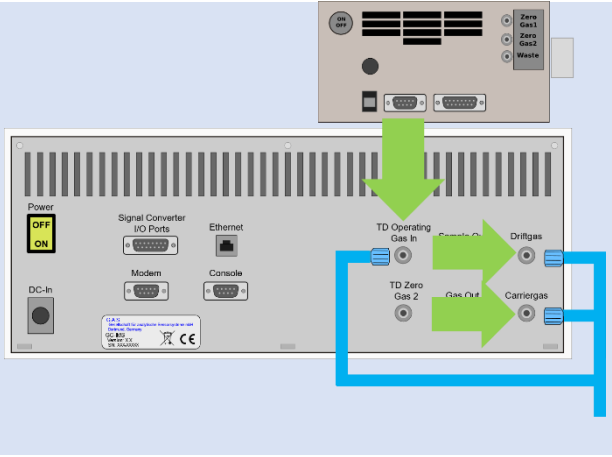

Connect TD operating gas in socket to **Driftgas- / Carriergas-Adapter** using a 3 mm Swagelok PFA tube.

12

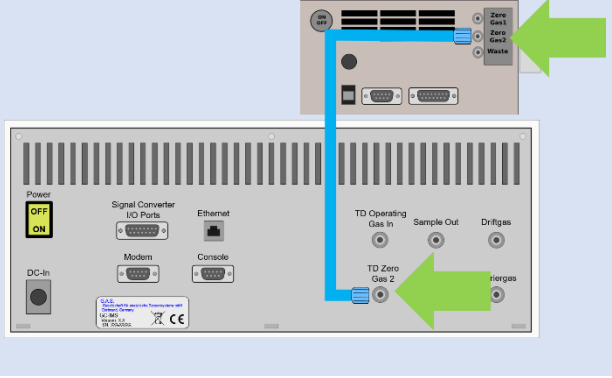

Also connect Outlet **ZeroGas 2** and **TDZero Gas 2** using a 3 mm Swagelok PFA tube.  
**For further information see: Airsense µTD manual**

13

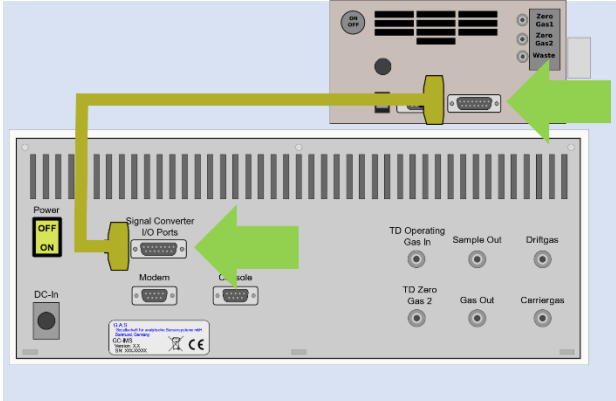

Connect BreathSpec **Signal Converter I/O-Port** to **μTD Digital Port** with appropriate Connection-Cable.

14

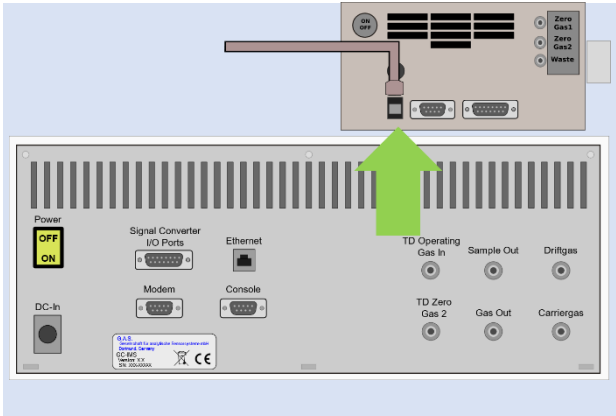

Connect the  $\mu$ TD with a computer via USB cable.

15



Connect the **μTD detector transfer line** to **sample in socket** of BreathSpec.

16



Connect **the μTD sampling transfer line** to  $\mu$ TD.

17

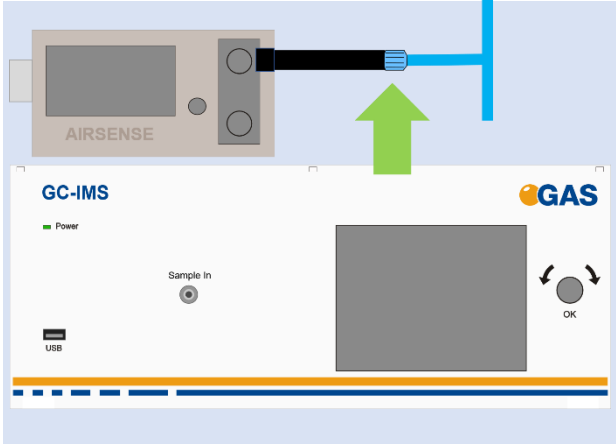

Connect a sample gas source to **sampling transferline** with the delivered **bypass adapter**.

18

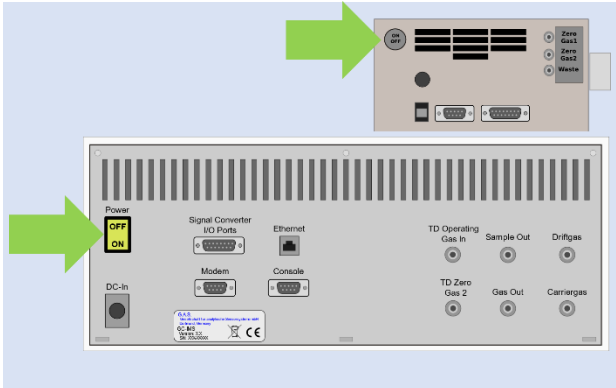

Switch on both devices.

19  
Option

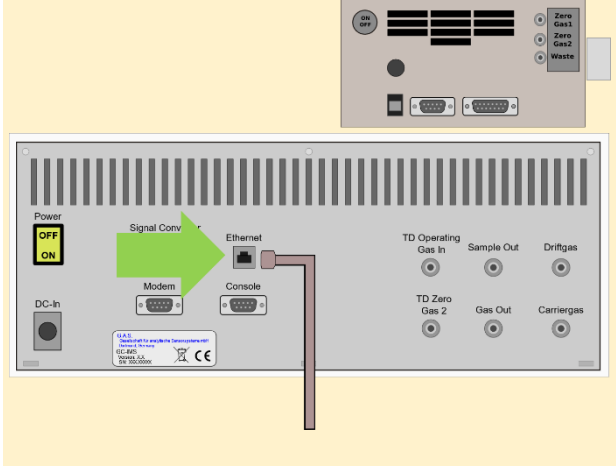

For file transfer via LAN: Connect the **Ethernet** socket with an appropriate Ethernet cable to a LAN.

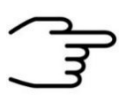

**INFORMATION!**  
For detailed information about the installation and operation of the  $\mu$ TD please refer the  **[\$\mu\$ TD-BreathSpec Quickstart Manual](#)** and the **[Airsense  \$\mu\$ TD Manual](#)**.



**INFORMATION!**  
When the  $\mu$ TD unit is connected to BreathSpec®, the current loop data output cannot be used.

**INFORMATION!**

The system is preset with the gas type nitrogen for drift gas and carrier gas. Normally, nitrogen or synthetic air in quality 5.0 is used.

**The default values can be adjusted by the customer.**

### 8.3 Warm-up phase after device switch-on

After switching on, the device is in the warm-up phase. The warm-up phase serves to protect the system against potential electronic damage which can be caused by condensation of humidity occurring during longer switch-off phases, e.g. transportation or storage.

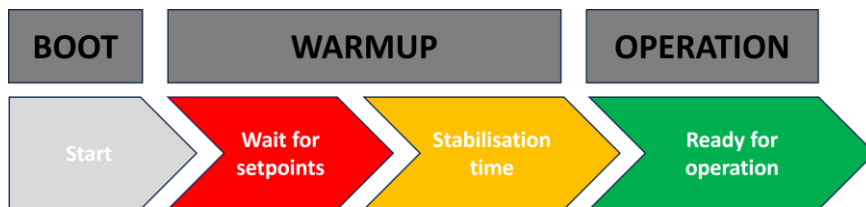

The warm-up phase is divided into two sub-phases:

#### Phase 1: Waiting for setpoints

All set temperatures must be reached and stable for 30 seconds before switching to phase 2.

#### Phase 2: Stabilization time

When all temperatures are stable, it takes up to one hour until the system is ready for operation.

The maximum duration of the warm-up phase is limited to 2 hours. The system's high voltage is switched off during this time.

**INFORMATION!**

The warm-up phase can be interrupted at any time by the user at his own risk.

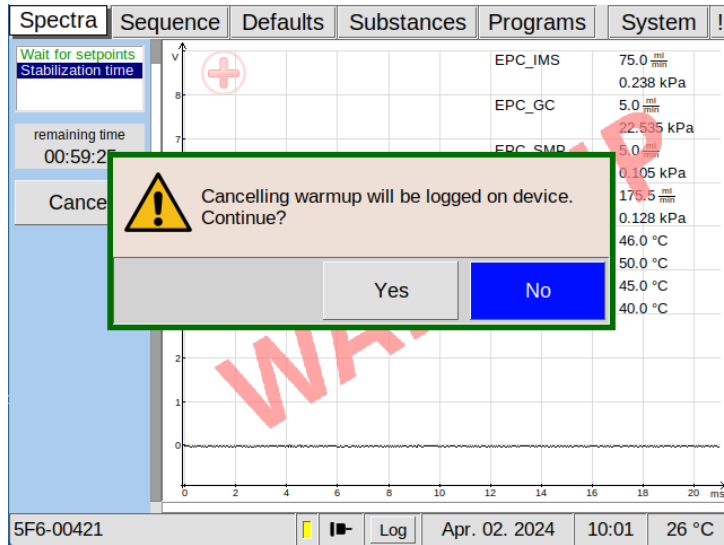

Figure 83: Warm-up Cancelling Window

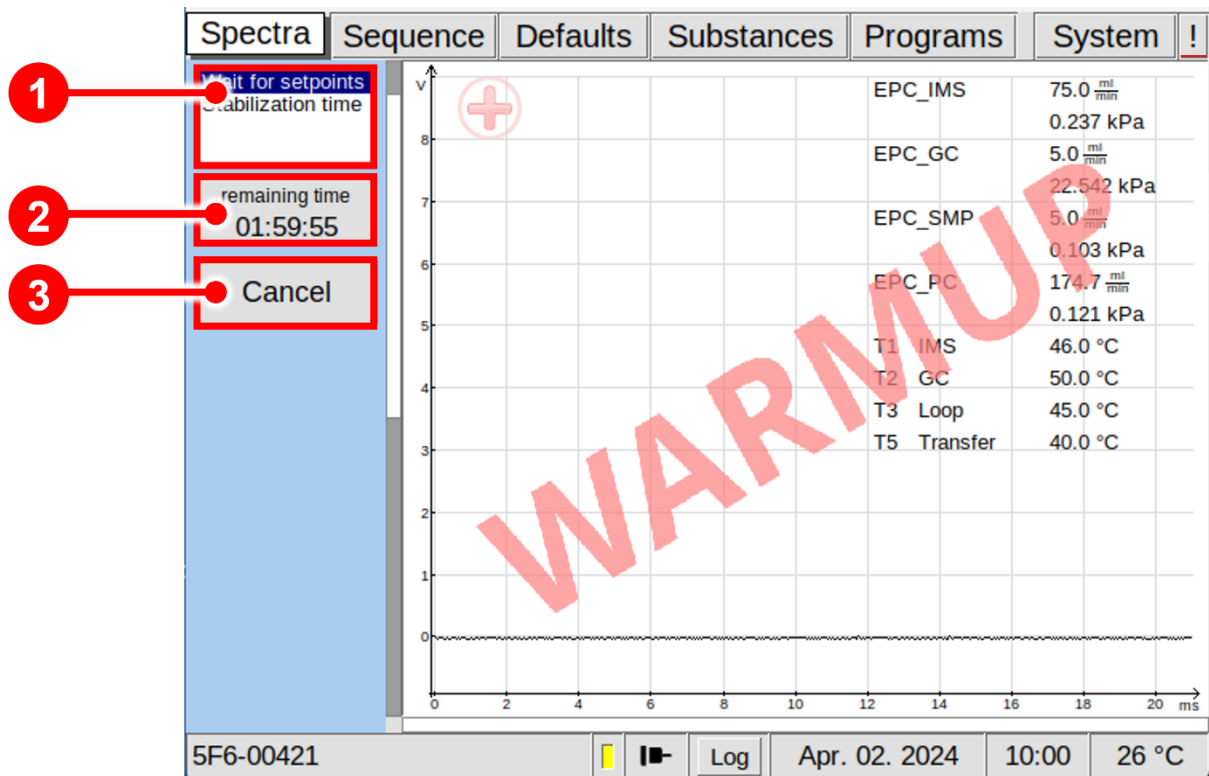

Figure 84: Spectra Window during the Warm-up phase

1	<b>Warm-up Status Window</b>	Displays the current status of the warm-up phase: <b>Phase 1: Waiting for setpoints</b> <b>Phase 2: Stabilization time</b>
2	<b>Warm-up Remaining Time Window</b>	Shows the remaining time of the warm-up phase
3	<b>Warm-up Cancel Button</b>	The user can cancel the warm-up process with this button.

## 8.4 Prepare the device for operation

Before using the device for the first time or after being disconnected from the nitrogen source for some time it must be cleaned to ensure proper operating conditions. In this case start the **Cleaning mode**.

An appropriate cleaning period duration must be chosen depending on how long the device was switched off and on the extent of contamination. It is recommended to clean the device for at least **15 hours** before operating it for the first time. If the Spectrum is not clean repeat the process. A **reference spectrum** for the evaluation can be found in the supplied **Analytical Approval**.



### INFORMATION!

After the cleaning process the device needs at least **2 hours** to cool down the internal components to their required temperatures.

The duration of the cool down process is depending on the temperature default settings.

**1**

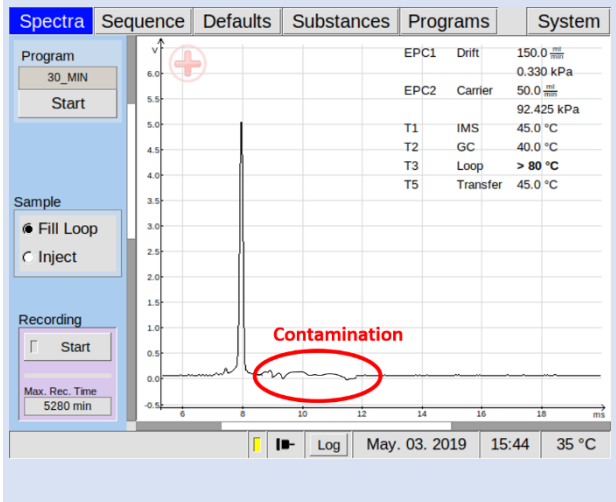

Inspect spectrum for contamination. Control the baseline. Start cleaning when contaminated. Contamination is indicated by peaks or the disappearing of the RIP.

**2**  
Option

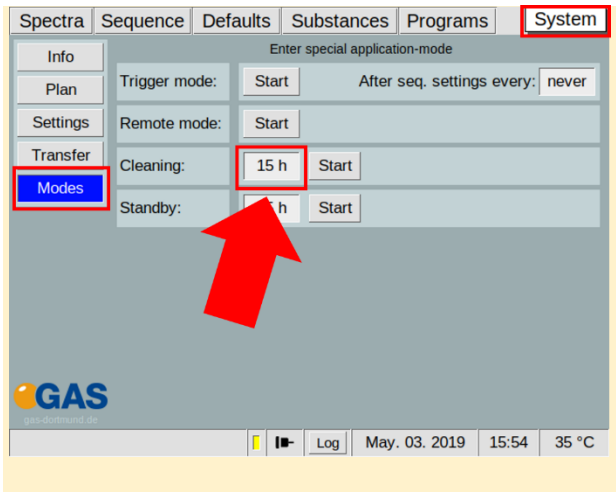

Select duration in hours:  
**System** > **Modes** >  
**Cleaning Mode** > **x h**

**3**  
Option

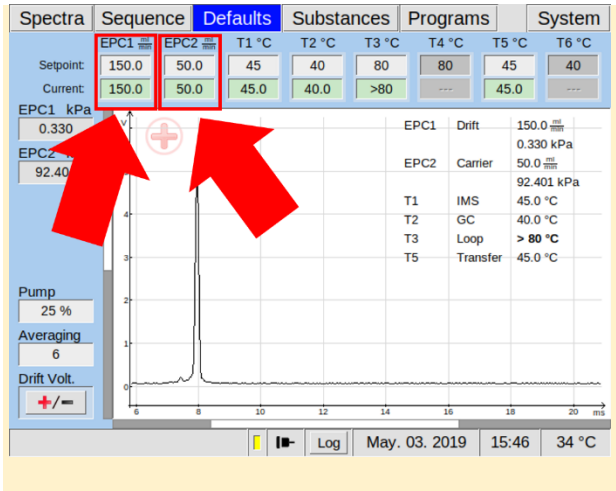

Change image!!!  
 To speed up this process, increase flow rate of EPC\_IMS and EPC\_GC to their maximum values (e.g 500/150 ml/min):  
**Defaults** > **EPC\_IMS** >  
**EPC\_GC**

4

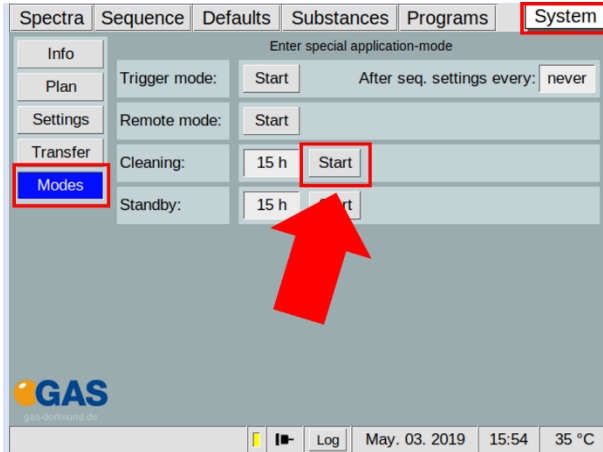

Start cleaning:

**System** > **Modes** >

**Cleaning Mode** > **Start**

5

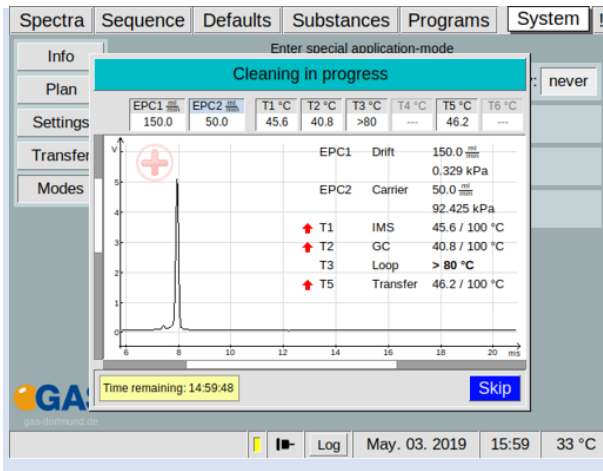

Wait until cleaning process is completed.

The process can be stopped with **Skip**.

6

The screenshot shows the 'Spectra' tab of the software. On the left, there are controls for 'Program' (30\_MIN), 'Sample' (Fill Loop selected), and 'Recording' (Start button, Max. Rec. Time 5280 min). The main area displays a chromatogram with a single sharp peak at approximately 8 minutes. To the right of the chromatogram is a table of parameters:

EPC1	Drift	150.0
		0.330 kPa
EPC2	Carrier	50.0
		92.425 kPa
T1	IMS	45.0 °C
T2	GC	40.0 °C
T3	Loop	> 80 °C
T5	Transfer	45.0 °C

Below the chromatogram is the 'Analytical Approval' section with the G.A.S. logo. It contains a table of device specifications:

Type:	BreathSpec® + µ-TD
Serial number:	5G2-00450
Working principle:	Ion Mobility Spectrometry (IMS)
Ionisation:	β-radiation source (Tritium ( <sup>3</sup> H))
Sensor number:	00060120
Column type:	MXT-WAX, 30 m L, 0.53 mm ID, 0.5 µm FT
Firmware Version:	4.14
Year of construction:	2023
µ-TD Serial Number:	

Below this is a table of 'Measurement conditions':

Drift gas flow rate:	75 mL/min	Carrier gas flow rate:	5-50 mL/min
Drift gas type:	Nitrogen 5.0	Carrier gas type:	Nitrogen 5.0
Drift gas pressure:	0,150 kPa	Carrier gas pressure:	22,122 kPa
IMS temperature (T1):	45 °C	Column temperature (T2):	40 °C
Loop temperature (T3):	45 °C	Transferline temperature (T5):	40 °C
Valve opening time:	6 sec	Averages:	6
Trigger duration:	100 µs	RIP voltage:	positive
Testmix/ Calibration sample:	Testmix_HS6_M3	Concentration range:	162-164 ppb
Sample-Test gas flow rate (Pump 30%):	~171 mL/min	Measurement runtime:	30 min
Program:	QC	Date of measurement:	04.08.2023

At the bottom of the screenshot, there are two smaller plots: a chromatogram on the left and a heatmap on the right.

After all temperatures reached the default values inspect visually the current spectrum and compare it with the reference spectrum of the analytical approval. **The RIP should reach ~80% of the RIP height displayed in the delivered Analytical Approval of the device when the same measurement conditions are used (as applied at G.A.S.).** The assessment of the readiness to measure is additionally supported by the system.

If not check the gas quality and/or install additional purification cartridges and start the cleaning procedure again.

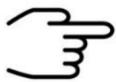

**INFORMATION!**

The device is delivered with an acceptance snapshot. This snapshot defines the system performance during device acceptance and is used to assess the readiness for measurement. Any deviations from this are displayed in the Error Information Window. **The default values can be adjusted by the customer.**



**INFORMATION!**

The system is preset with the gas type nitrogen for drift gas and carrier gas. Normally, nitrogen or synthetic air in quality 5.0 is used.

**The default values can be adjusted by the customer.**

## 9 System Operation (How to...)

### 9.1 Measurement Requirements



**INFORMATION!**

Only use the original accessories supplied with the device.



**INFORMATION!**

Make sure that the gas quality is 5.0 (99,999%) or better.



**INFORMATION!**

Only use stainless steel pressure reducer.



**INFORMATION!**

Make sure that the spectrum is clean a without contamination.



**WARNING!**

Do not introduce any liquids. This can destroy the device.

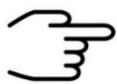

**INFORMATION!**

Make sure that that all temperature-, flow- and pressure values have reached their default value and are stabilized.



**INFORMATION!**

Make sure that the correct gas types are set for drift gas and carrier gas. The default setting is nitrogen.

### 9.2 Measurement Program

The BreathSpec will **by default** be equipped with a general measurement program called **'BREATH'**. This program may need to be subject for method optimization **see**

**chapter 6.6.** Please be aware that editing the program may require changes in the timeline of sampling to sample the exhaled breath.

The following workflows describe the analysis of human breath exemplarily using the 'BREATH' program.

## 9.3 Breath Sampling via Handheld Breath Sampler

### 9.3.1 Installation of Disposable Reservoir Tube and Mouthpiece

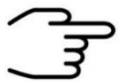

#### INFORMATION!

To sample via the handheld breath sampler, the respective tube port must be installed [see chapter 7.4](#).



#### DANGER

- Biohazard: wear appropriate gloves at all handling steps
- Take measures to prevent contamination from one subject/patient to other



#### WARNING

- Pinching possible

1



The image shows the parts necessary to set up the device for a breath analysis.

## BreathSpec® – User Manual

2



Insert new reservoir tube.

Check matching of Luer tip and reservoir's drilled hole.

The luer tip is the exit of a disposable 2 ml Syringe, see Workflow 9.3.3 for more information.

3



Plug in the mouthpiece into narrow end of the reservoir tube. Screwing the mouthpiece may ease plugging in.

4



The image shows installed reservoir tube kit.

### 9.3.2 Execute a breath measurement using the Handheld

1

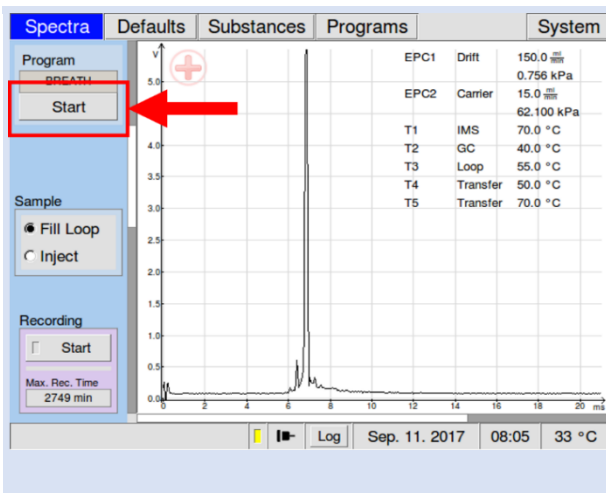

Select the **Start** button.

The dialog 'Start program' appears.

2

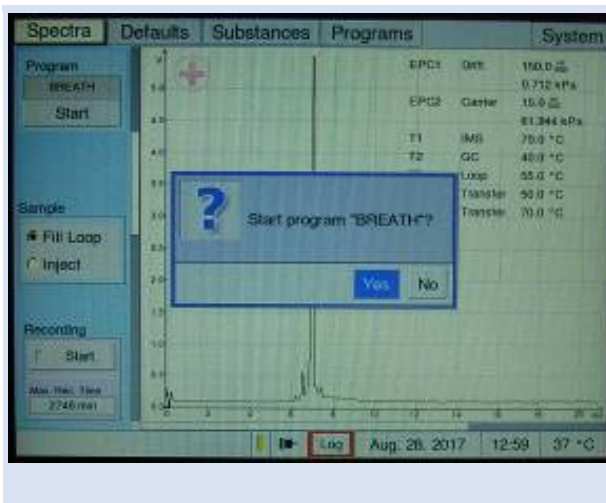

Select the **<Yes>** button with the pushable rotary knob (focus - background is blue), but do not click on **Yes** yet .

3



Ask the subject/patient to exhale smoothly into the mouthpiece mounted on the handheld.

[in case of a mistrial (cough etc.) the subject/patient can repeat exhalation]

{best practice is letting the subject/patient exhale into



the handheld still attached to the device without touching it. If touched, the handheld can be wiped clean with an alcohol-free tissue}

4

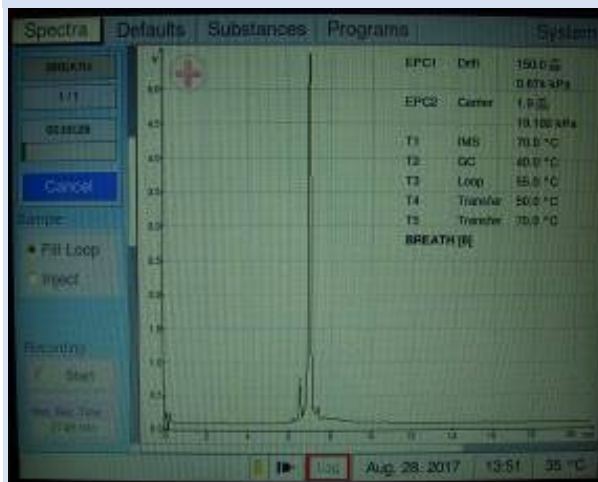

Upon ending of exhalation, the operator presses the pushable rotary knob to start the selected program.

[Arranging a sign with the patient to indicate ending of exhalation may be of benefit to match the right starting point]

> subject/patient can stop exhaling

> analysis is initiated  
(progress bar indicates runtime)

5



Pull out the used disposable reservoir tube.

The analysis will continue as defined in the program (15 min for the preinstalled 'BREATH' program)

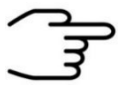

**INFORMATION!**

Dispose the syringe, reservoir tube and mouthpiece.

### 9.3.3 Exchanging the inner syringe body

The sampling tube is capped by a disposable syringe body to allow exchanging of all parts that are in direct contact to breath. The syringe's Luer tip protrudes from the handheld sampler (see images below).

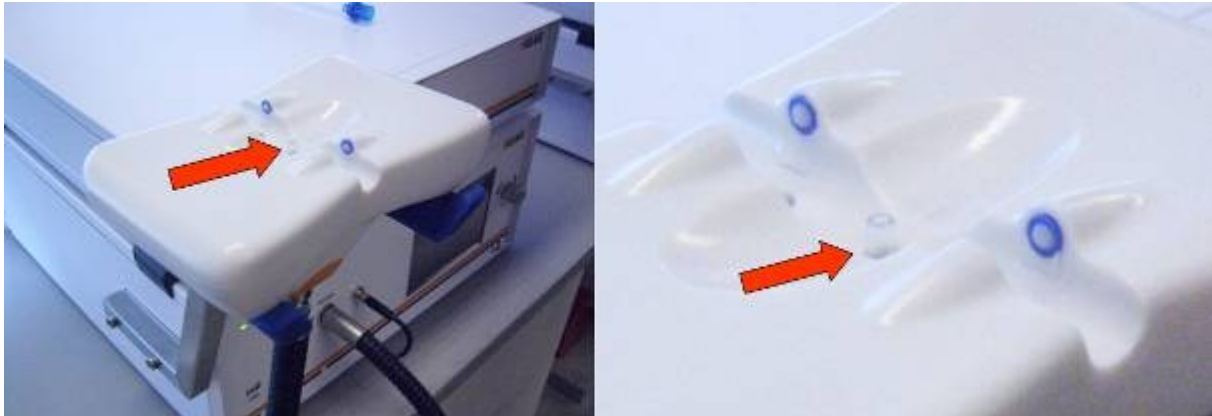

The procedure steps are described as follows:



#### DANGER

- Biohazard: wear appropriate gloves at all handling steps
- Take measures to prevent contamination from one subject/patient to other



#### WARNING

- Pinching possible

1

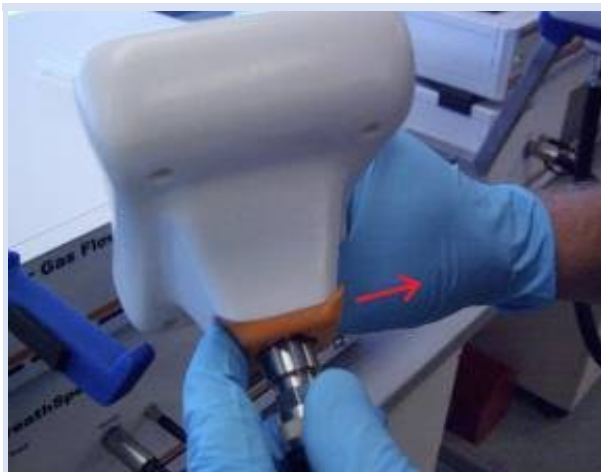

- move click located at the bottom of the handheld to disconnect handheld and tube and pull out the tube.

2



- pull syringe body from tube

3



- remove piston from a new, clean syringe and impose syringe body on tube

4



- re-insert tube equipped with new syringe body into handheld

### 9.3.4 Execution of an ambient air measurement using the Handheld

The analysis of the ambient air may indicate volatile compounds that do not originate from the subject/patients breath but are present in the air.

To analyze the ambient air follow the steps described in 9.3.2. A Reservoir tube and Mouthpiece must not be installed.

## 9.4 Breath Sampling via Disposable Breath Sampler

### 9.4.1 Start a breath measurement using disposable breath sampler

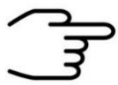

#### INFORMATION!

To sample via the Luer-Lock-Adapter the respective tube port has to be installed [see chapter 7.5](#).



#### DANGER

- Biohazard: wear appropriate gloves at all handling steps
- Take measures to prevent contamination from one subject/patient to other



#### WARNING

- Pinching possible

1

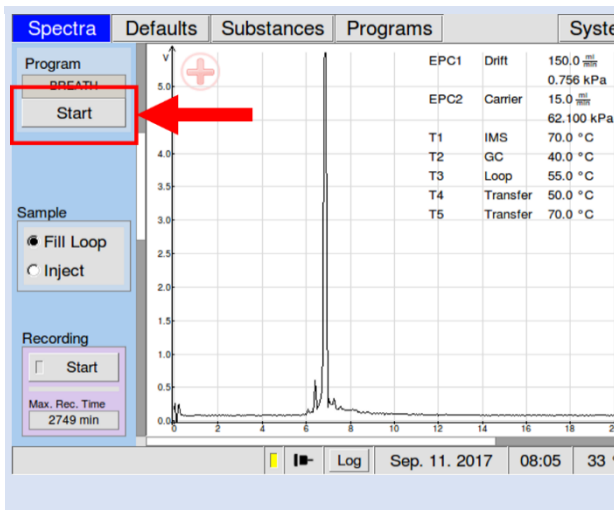

Press Start Button to initialize the selected program.

The **dialog** 'Start program' appears.

2

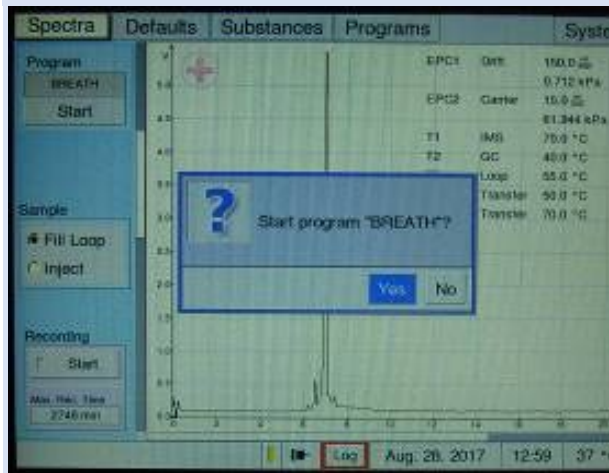

Select the **<Yes>** button with the pushable rotary knob (focus - background is blue), **but do not hit Yes yet.**

3



Plug in the mouthpiece into the narrow end of the reservoir tube. Screwing the mouthpiece may ease plugging in.

4



Connect the 5 ml Syringe with the reservoir tube. Screwing the mouthpiece may ease plugging in.

5



Ask the subject/patient to exhale smoothly into the mouthpiece mounted on the handheld.

During the exhalation sample breathing air into the syringe.

[in case of a mistrial (cough etc.) the subject/patient can repeat exhalation]

[Note that the breath sample may alter with time in the syringe]

6



Disconnect the syringe from the reservoir tube.

Insert the syringe into sample in connector with integrated Luer port.

Smoothly inject the breathing air into the sampling Luer port.

Towards the ending of injection press the pushable rotary knob to start the selected program.

7

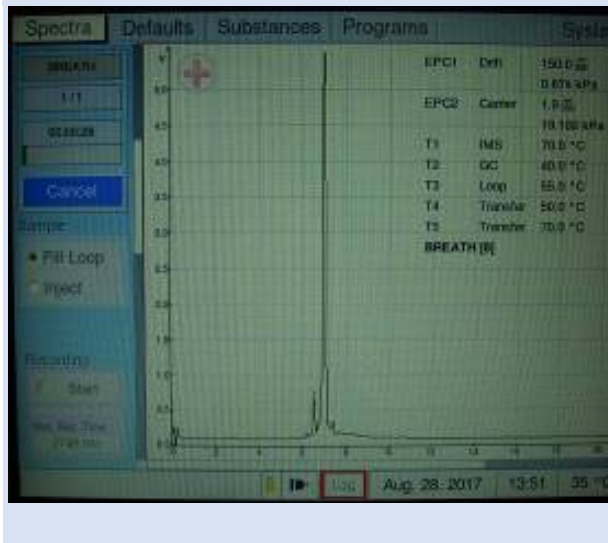

> analysis is initiated  
(progress bar indicates  
runtime)



### INFORMATION!

THE DESCRIBED MODE OF OPERATION ONLY WORKS WITH THE DEFAULT BREATH PROGRAM. PROGRAM ADJUSTMENTS BY THE USER MAY REQUIRE ADJUSTMENTS IN THE SAMPLING.



### INFORMATION!



Dispose the syringe, reservoir tube and mouthpiece.

#### 9.4.2 Execution of an ambient air measurement using syringes

The analysis of the ambient air may indicate volatile compounds that do not originate from the subject/patient's breath but are present in the air.

To analyze the ambient air follow the steps described in chapter 9.4.1. The ambient air can be sampled directly into a syringe.

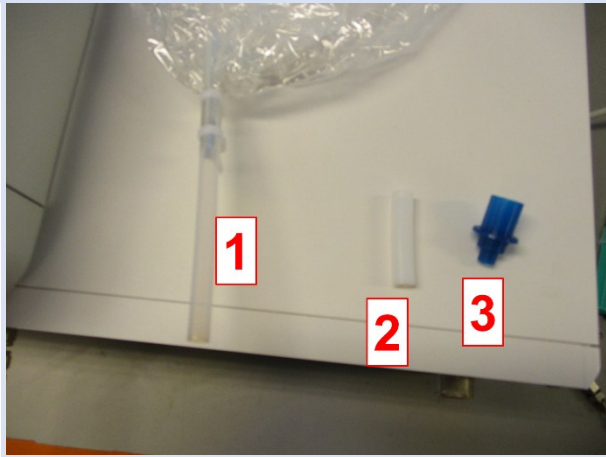
## 9.5 Exemplary Breath sampling with a sample bag

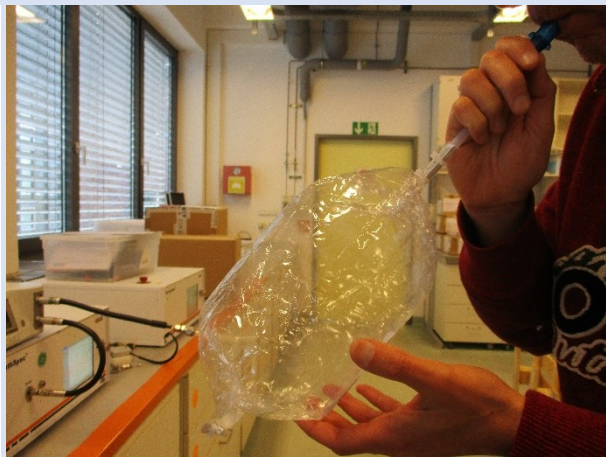
<b>1</b>		<p>The components for breathing air sampling with the gas bag:</p> <ul style="list-style-type: none"><li>1: Sampling bag</li><li>2: Sampling bag adapter</li><li>3: Mouthpiece</li></ul>
<b>2</b>		<p>Put all components together</p>
<b>3</b>		<p>Fill the sample bag with breathing air.</p>

4



Connect the sampling bag to  $\mu$ TD sampling Transfer Line .

5



Set BreathSpec to Triggemode and start the  $\mu$ TD.



**INFORMATION!**

- For detailed Information refer to the [Airsense  \$\mu\$ TD Handbook](#) and the  [\$\mu\$ TD GC-IMS Additional Information Quickstart](#)

## 9.6 Measurement in Normal mode

1



Select Normal Mode:

**System** > **Settings** >  
**Normal**

2



Select Start:

**Spectra** > **Start**

3



Preselect **OK** in the dialog box, but do not start.

4



Insert the sample (here exemplary with syringe and Luer-Adapter) and start the program by pressing the rotary knob.

## 9.7 Measurement in Simplified mode

1

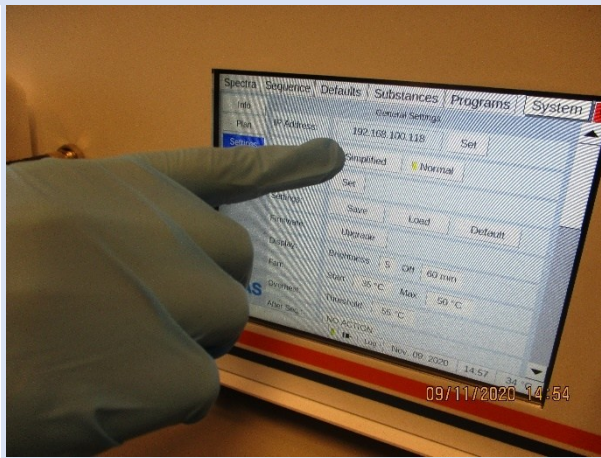

Select Normal Mode:

**System** > **Settings** >  
**Simplified**

2

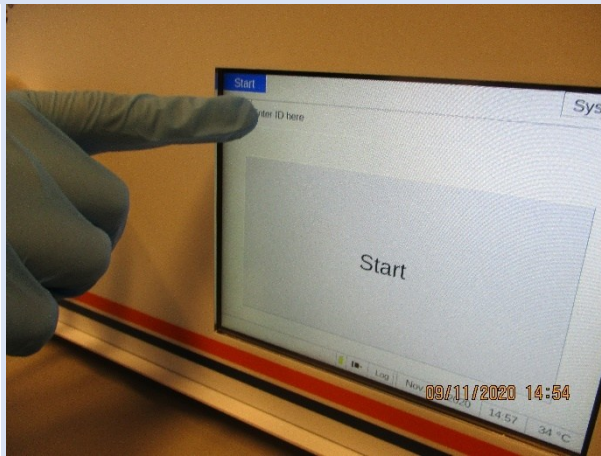

In simplified window select the **ID field** and enter an ID.



### INFORMATION

The entry of an ID is only possible in Simplified Mode and is mandatory.

3

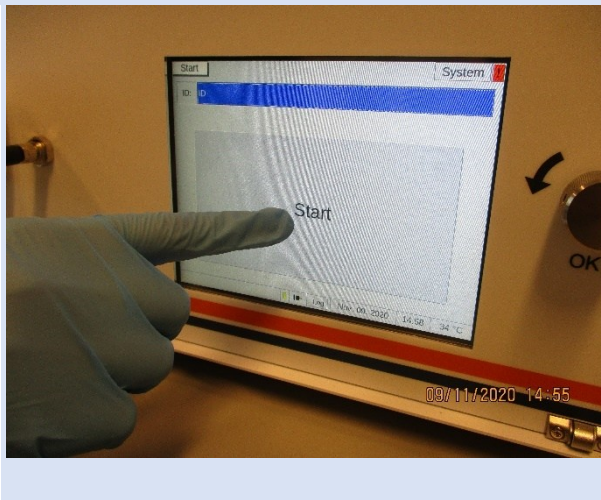

Select Start:

**Start** > **Start**

3

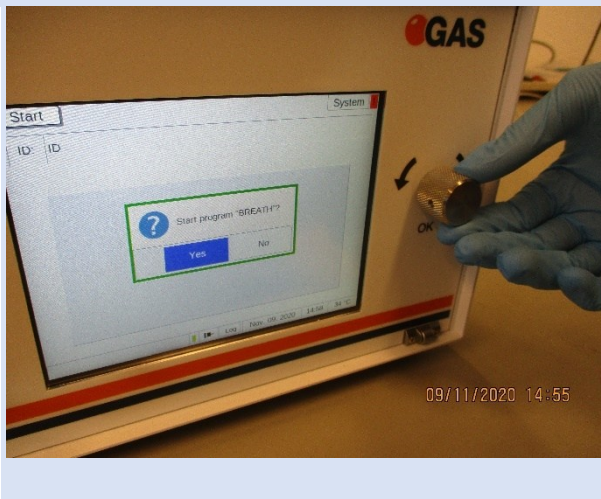

Preselect **Yes** in the dialog box, **but do not hit Yes yet.**

4



Insert the sample (here exemplary with syringe and Luer-Adapter) and start the program by pressing the rotary knob.

## 9.8 Measurement in ID Input Mode

**1**

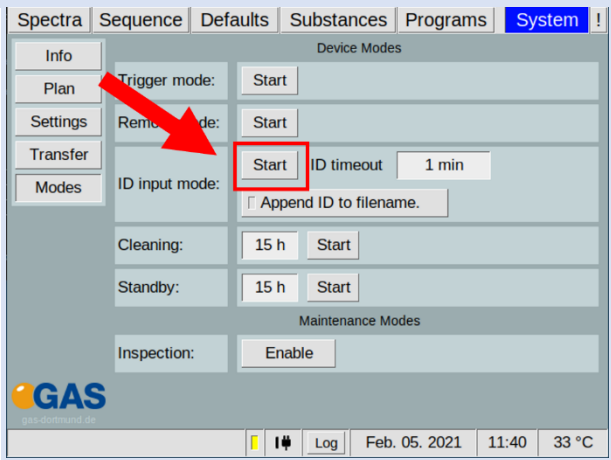

Select ID Input Mode:  
**System** > **Modes** > **ID Input Mode** > **Start**

**2**

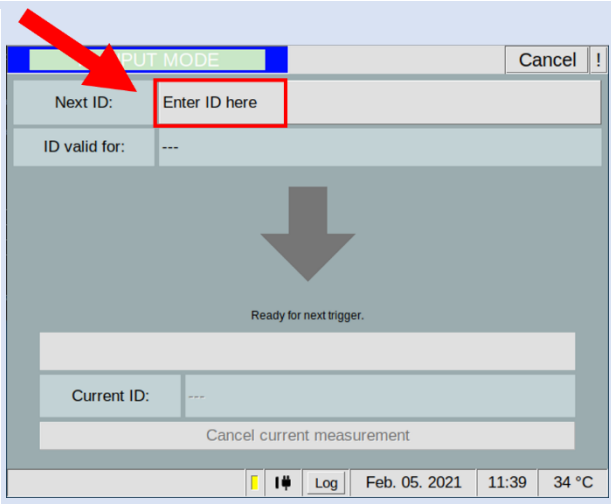

In ID Input Mode window select the ID field and enter an ID.

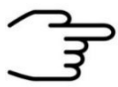

### INFORMATION

The entry of an ID is mandatory.

3



Start measurement with  $\mu$ TD-start button.

## 9.9 Manual Measurement Recording

1

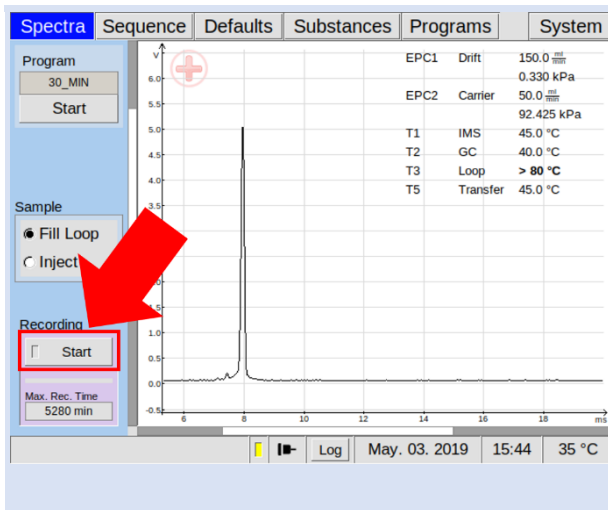

To record a measurement manually select:

**Spectra** > **Recording-Start**

2

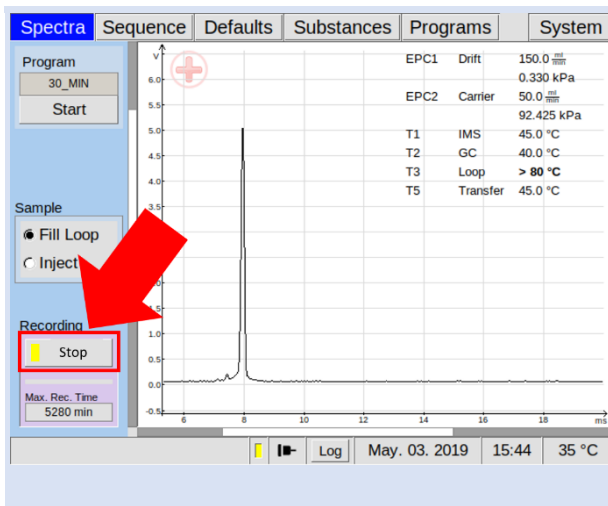

To stop the measurement, select:

**Spectra** > **Recording-Stop**



### INFORMATION!

The maximum measuring time is limited to **59 minutes 59 seconds and 980 milliseconds**.

## 9.10 Adjusting the gas type settings



### INFORMATION!

The electronic pressure regulators for drift gas (EPC\_IMS), carrier gas (EPC\_GC), uTD gas (EPC\_SMP) and Sample gas (EPC\_PC) are preset with the gas type nitrogen. If other gas types are used, these must be adapted by the user. Usually, nitrogen or synthetic air of quality 5.0 is used.

<b>1</b>		<p>Select the <b>system window</b></p>
<b>2</b>		<p><b>Select</b> EPC settings <b>Edit</b></p>

3

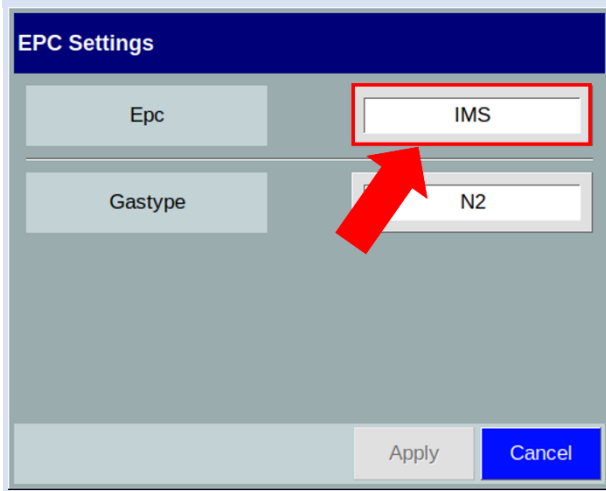

Select the available EPCs. **IMS** (drift gas), **GC** (carrier gas) **SMP** (uTD gas) and **PC** (sample gas pump control) are available depending on the device model.

4

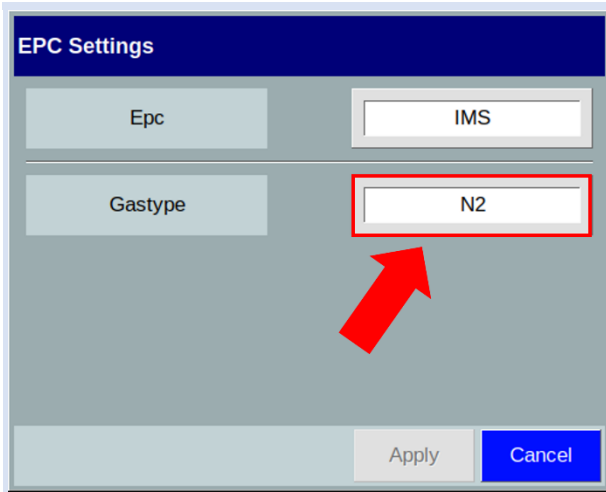

Select the Gastype. All available gas types of the electronic pressure controllers are displayed. Usually **nitrogen** or **synthetic air** is used.

5

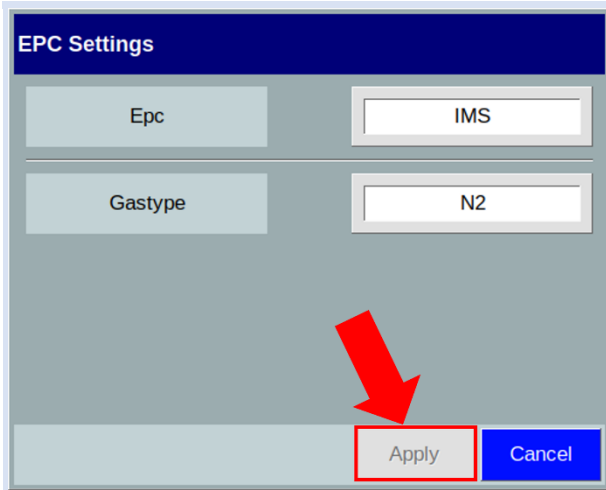

Press **apply** to confirm.

## 9.11 Test Pump Flow Control



### INFORMATION!

The sample pump is EPC-monitored and controlled (**EPC PC**). Changing environmental parameters (e.g. changing sample tube lengths or decreasing pump duty) requires a calibration of the parameters.

1

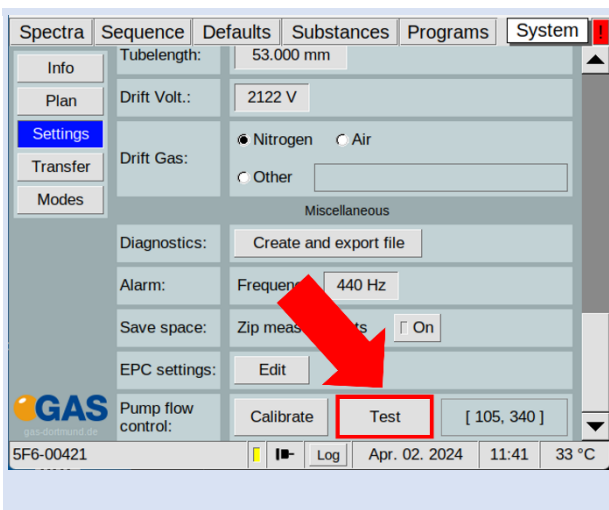

To test the pump flow control select:  
**System** > **Settings** > **Test**

2

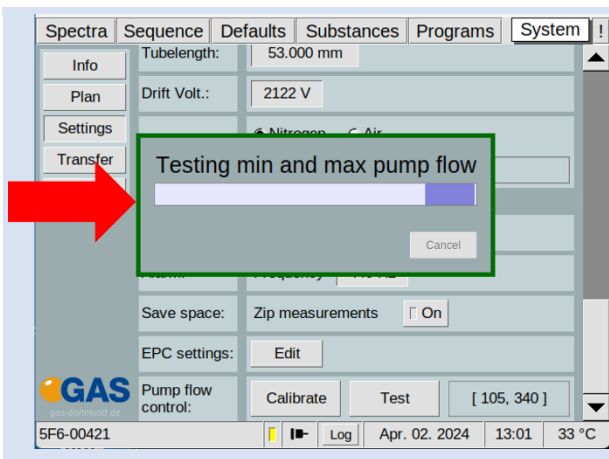

The reachable MIN and MAX flow values are checked.

3

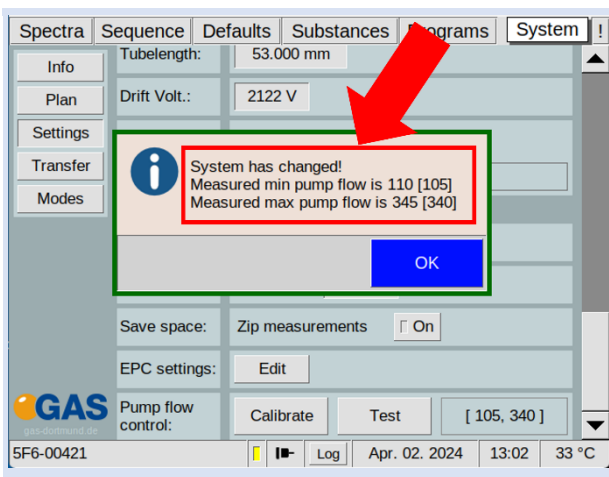

The measured and saved MIN and MAX flow values are displayed.  
 New Value: **100**  
 Stored value: **[105]**

4

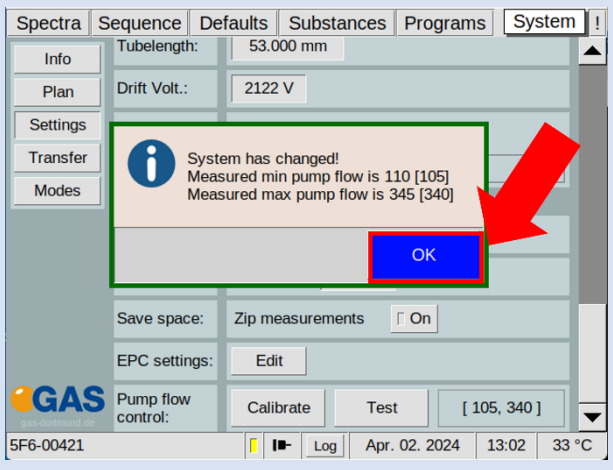

Close the window by clicking **OK**



**INFORMATION!**  
It is recommended to test the pump flows regularly

## 9.12 Calibrate Pump Flow Control



### INFORMATION!

The sample pump is EPC-monitored and controlled (**EPC PC**). Changing environmental parameters (e.g. changing sample tube lengths or decreasing pump duty) requires a calibration of the parameters.

1

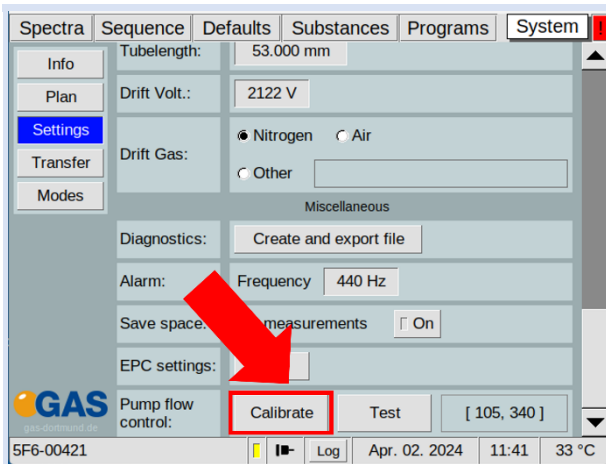

To calibrate the pump flow control select:

**System** > **Settings** > **Calibrate**

2

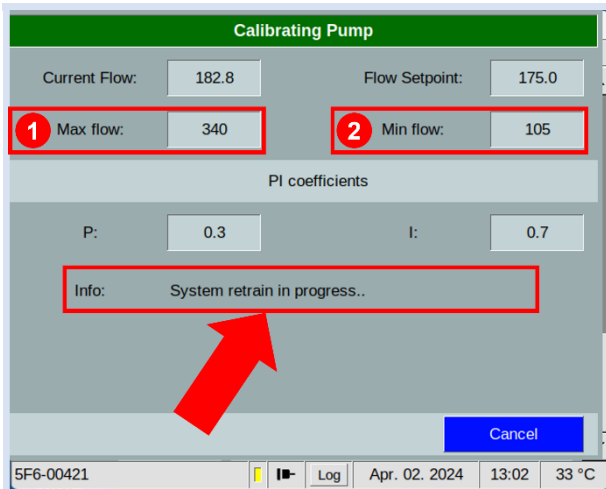

The possible MAX flow and MIN flow values are measured. The existing v MAX flow and MIN flow values are displayed

#### Example:

- 1 MAX flow: 340
- 2 MIN flow: 105

3

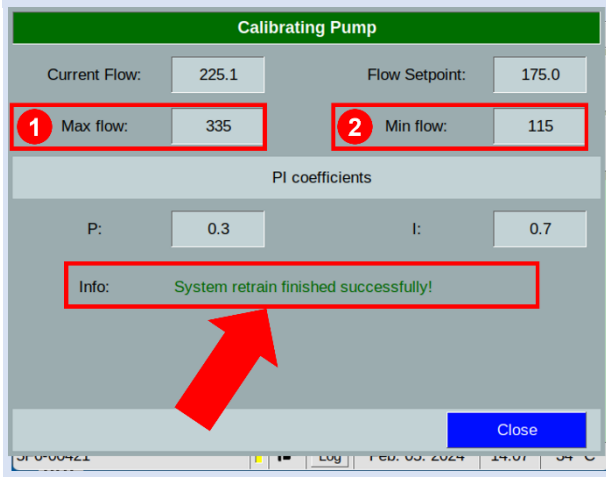

The new calibrated MAX flow and MIN flow values are stored.

**Example:**

- 1 MAX flow: 305
- 2 MIN flow: 115

4

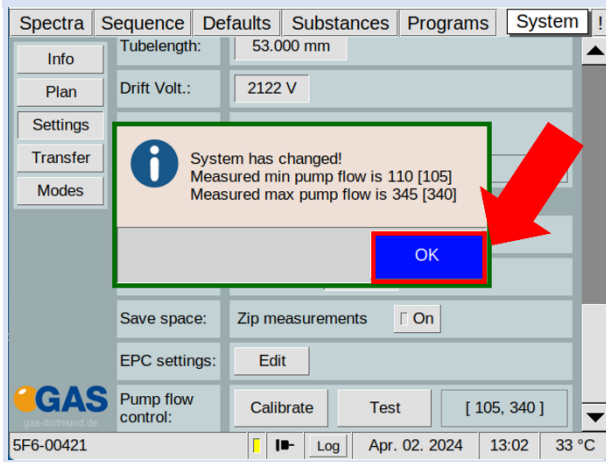

Close the window by clicking **OK**

### 9.13 Adaptation of existing programs to the pump flow control



#### WARNING!

Existing programs are no longer compatible after a firmware upgrade to version 4.50 and can no longer be executed. They must be adapted.

1

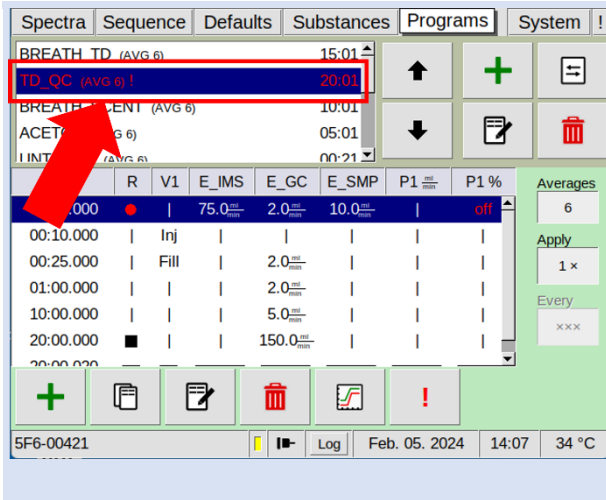

Incompatible programs are displayed in red and cannot be executed

2

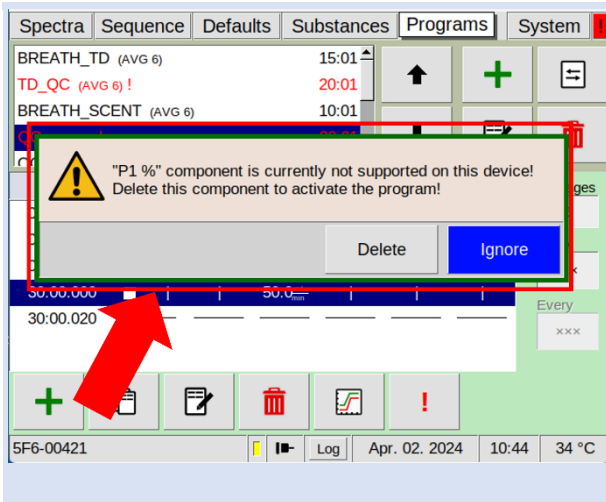

If such a program is selected, an error message appears and the incompatible pump parameter is displayed.

3

Time	R	V1	E_IMS	E_GC	E_SMP	P1 ml/min	P1 %
00:00.000	●		75.0 ml/min	5.0 ml/min			off

Time	R	V1	E_IMS	E_GC	E_SMP	P1 ml/min	P1 %
00:00.000	●		75.0 ml/min	5.0 ml/min		115.0 ml/min	

Example of incompatible pump parameter and adjusted pump parameter:

- 1 P1 %= incompatible
- 2 P1 ml/min= compatible

**P1% was deleted !**

### 9.14 Create a Measurement Program

1

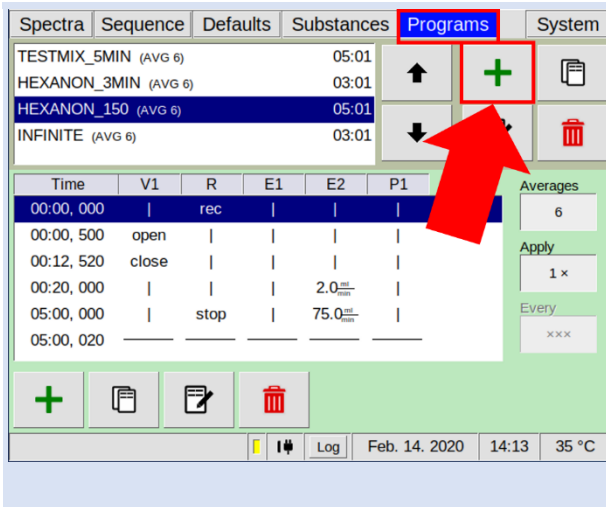

Select:  
**Programs**  
To create a new program select the Button

2

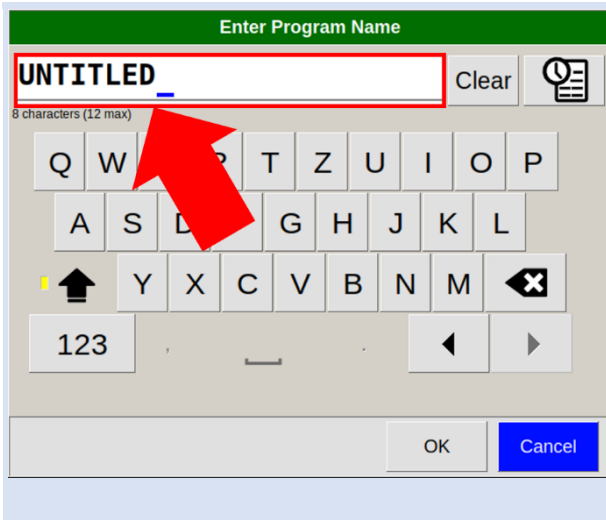

Enter a new program name or use the default name.

3

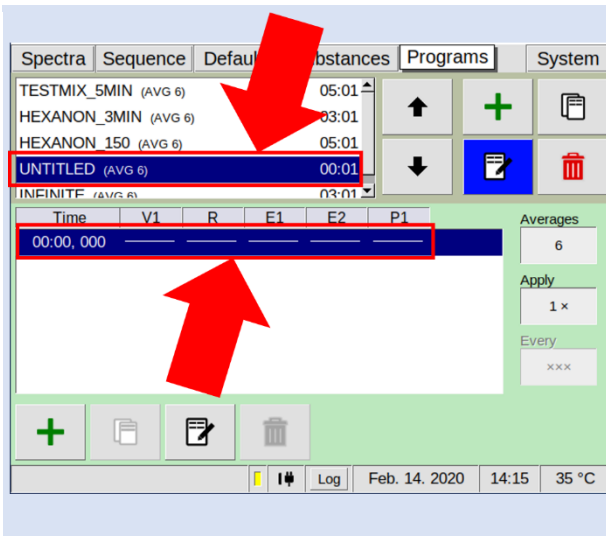

The program end time is displayed as the final line

4

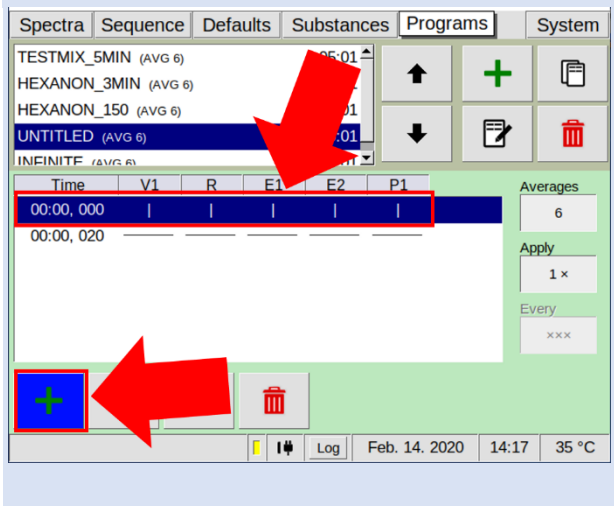

To create a new program action line select the Button 

5

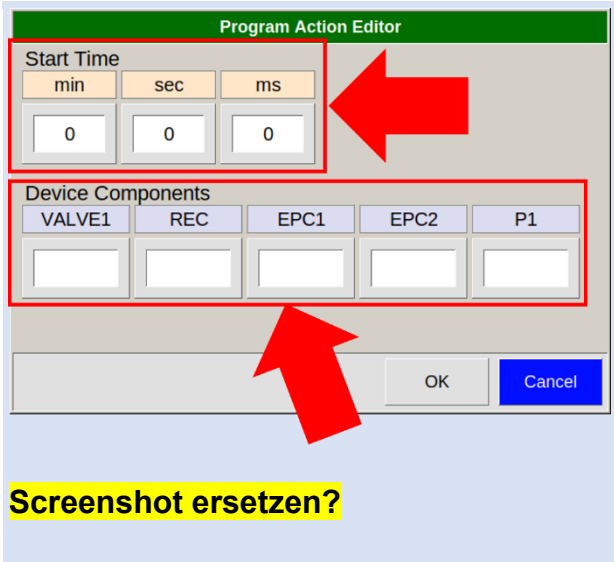

Screenshot ersetzen?

This line can be filled with values. For more information see also [Chapter 6.6.3 Edit Measurement Programs](#)

6

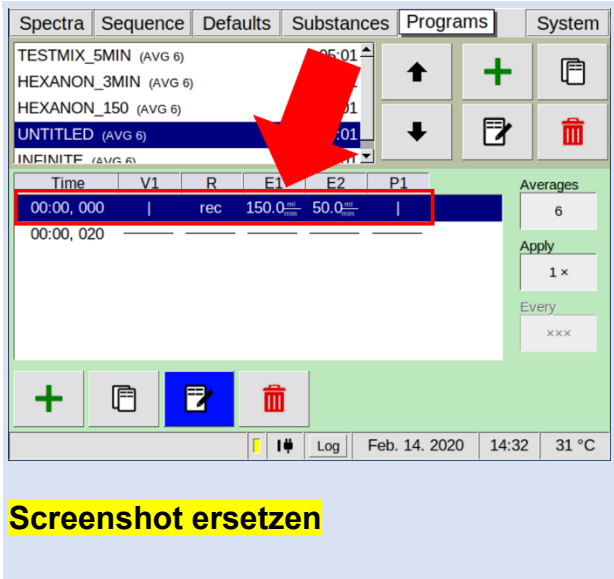

Screenshot ersetzen

After the necessary values have been entered, repeat step 4 and 5 to create the next program action line.

7

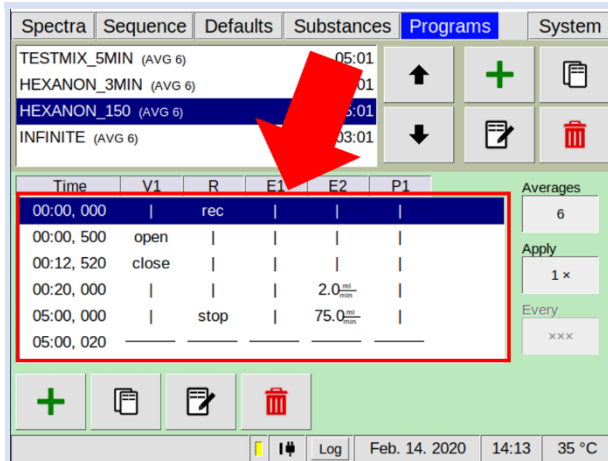

A complete program sequence can be created line by line.

**Screenshot ersetzen**

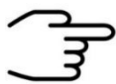

**INFORMATION!**

The device is delivered with standard programs that can be adapted to your needs.

Customer-specific programs can also be created optionally.

**9.15 Start Sequence**



**INFORMATION!**

The sequence file must be created with the **G.A.S. Sequence Designer Software**. For detailed Information refer to the **G.A.S. Sequence Designer Software Manual**.

1



To import a sequence select:

**Sequence** > **Start**

2

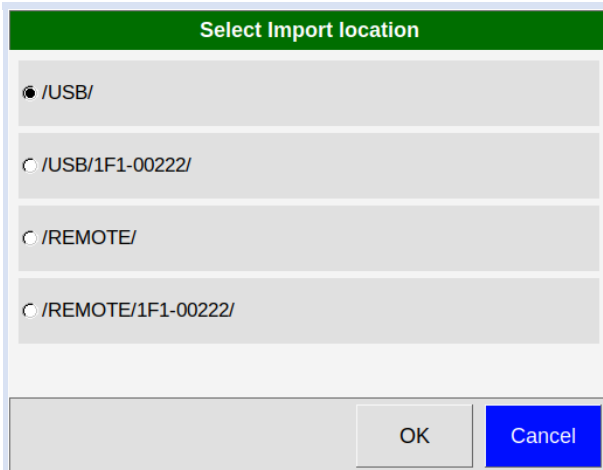

Select the import location of the sequence file and press **OK**

3

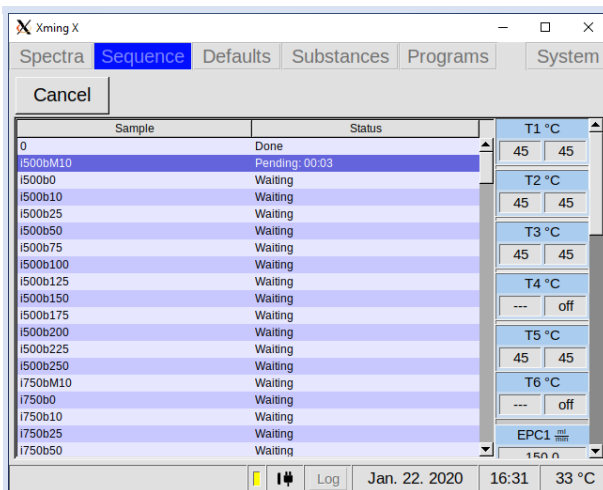

The Sequence will be executed.

After importing the sequence select **Spectra Start**



**INFORMATION!**

If the **tftp-protocol** is used for data transmission, the file has to be named **Sequence.json** for the software to recognize it. Make sure, that the parameters specified in the programs and after-run settings are within your devices permitted regions.



**WARNING!**

Careful when changing device critical parameters by applying After Run Settings. A device can become inoperable with faulty IMS parameters. After Run settings are also applied if the Sequence is cancelled by the user. In case of cancellation, the devices default parameters will be the same as if the sequence had successfully finished, taking all previous After Run Settings into consideration.



**INFORMATION!**

From firmware version 4.50, the use of the sequence designer from version 1.5 is mandatory.

## 9.16 Workflows: File Transfer Setup

### 9.16.1 Overview

Files can be transferred to and from the device by LAN connection and by USB device connected to the USB port at the front of the housing.



#### INFORMATION!

A connected USB device is always preferred to a LAN connection when exporting or importing files manually.



#### INFORMATION!

The USB device must be formatted to FAT32. Consult your system administrator on formatting USB devices.

Generated measurement files and measurement result files are stored on the internal storage volume of the device.

The following file types are generated from measurements:

File Type	Description
<b>MEA Measurement Files</b>	Contains the complete data of one single measurement including the raw sampling data.

When a connection to a server is established and the export is activated these files are copied to this server when created in the workflow. Measurement files once copied to one of these locations are marked and will be overwritten in case the internal storage is full.

By default, the **Service Message Block Protocol (SMB)** also known as Common Internet File System (CIFS) is used. The **Secure File Transfer Protocol (SFTP)** or a modified version of the **Trivial File Transfer Protocol (TFTP)** can also be used. LAN file transfer settings can be modified in **System** > **Transfer** > **Connection** > **Edit Server Details**.

Manual transfer of measurement files stored on the device can be done **System** > **Transfer** > **Mea Files** > **Copy to Remote**.

Manual transfer of measurement files stored on the device can be done **System** > **Transfer** > **Mea Files** > **Delete**.

### 9.16.2 Connecting to a Server in a LAN



**INFORMATION!**  
Some PC Ethernet interfaces may not be suited for a direct connection to the device. In that case consider using an Ethernet switch to connect both devices.

**1a**

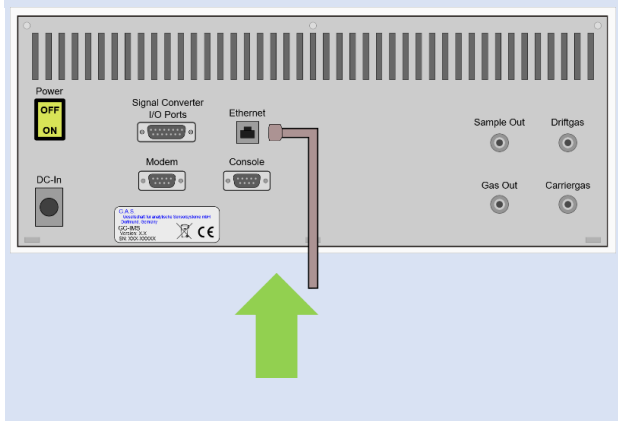

Connect the device with a standard Ethernet cable (LAN cable) to the LAN or directly to a computer.

**1b**

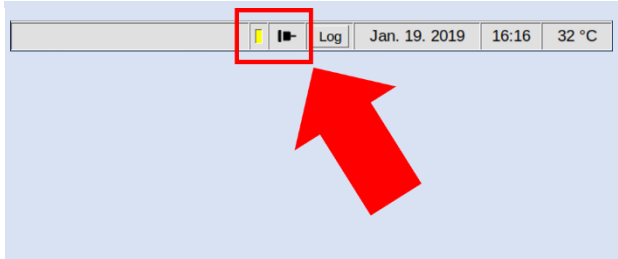

In the status bar the connection icon is displayed.

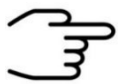

**INFORMATION!**  
Make sure that any firewall present in the network does not block necessary traffic. Consult your system administrator on how to configure your firewall.



**INFORMATION!**  
Consult your system administrator on how to set up a server with one of the protocols **SMB** and **SFTP**. The **TFTP** protocol requires the G.A.S. TFTP Server software to run on a Microsoft® Windows® computer.

**2a**  
Option

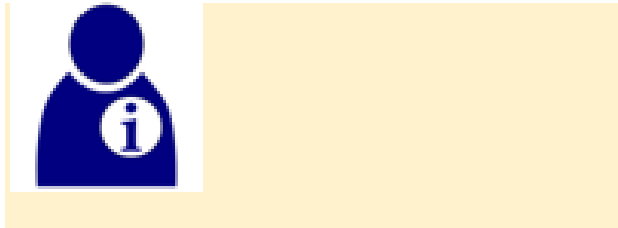

For **SMB** set up a SMB share on a server. Consult your system administrator on how to do that.

## 2b

Option



For **SFTP** set up a SFTP server. Consult your system administrator on how to do that.

For an example SFTP server for Microsoft® Windows® PCs see:

<http://www.coreftp.com/server>

## 2c

Option



For **TFTP** install the G.A.S. IMS-Control TFTP-Server on the PC. For detailed information see the [IMS Software Suite IMScontrol TFTP-Server manual](#).

## 3a

Option

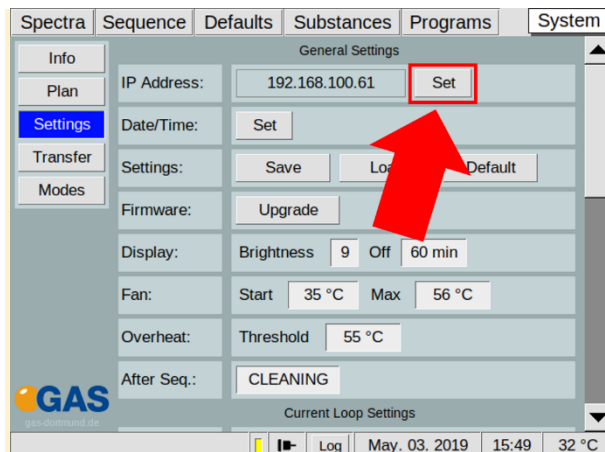

**Set a static device IP** (Recommended for direct connection of PC and device):

**Use System** > **Settings** > **Set**

In the next dialogbox select: **Yes**

# 3b

## Option

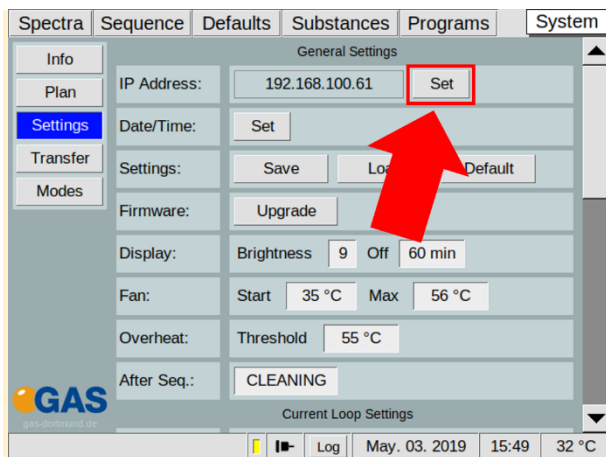

### Get device IP From DHCP Server

(Recommended for LAN integration of the device):

**Use System** > **Settings** > **Set**

In the next dialogbox select: **No**



### INFORMATION!

Note that both devices must be in the same subnet mask area of **255.255.255.0** i.e. only differ in the fourth number of the four-part IPv4 address.

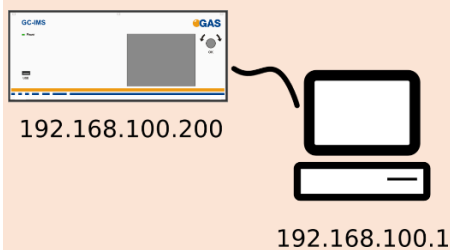

# 4

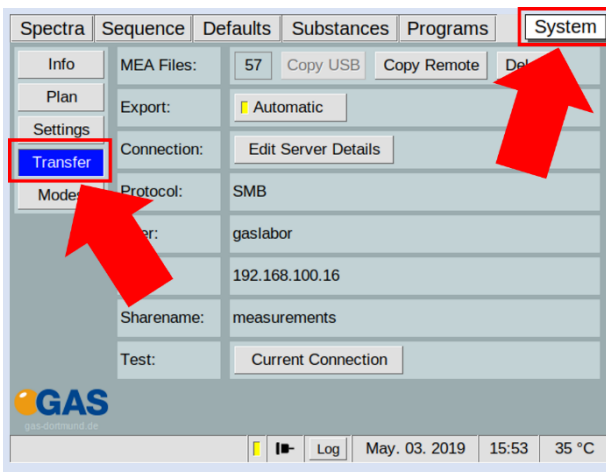

Open **System** > **Transfer**

5

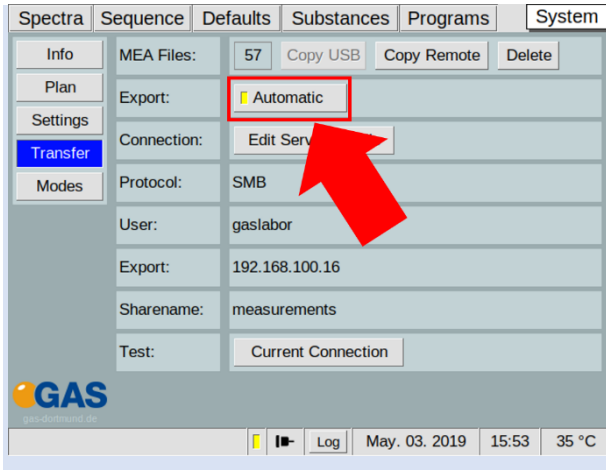

Activate or deactivate automatic file transfer to the server with **Automatic Export**.

6

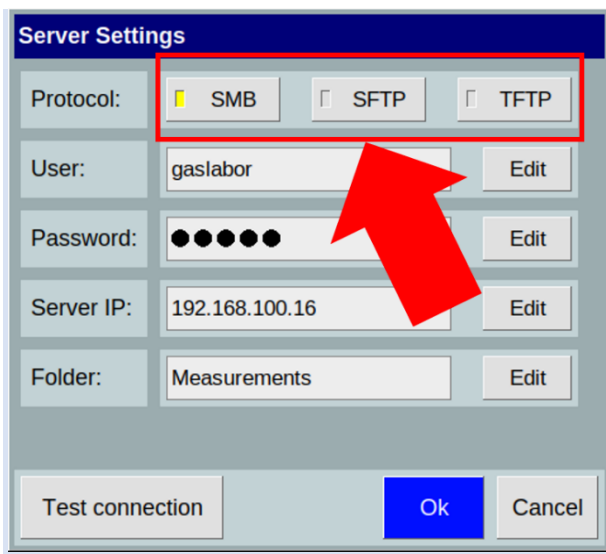

Select the desired protocol **SMB**, **SFTP** or **TFTP**.

7a  
Option

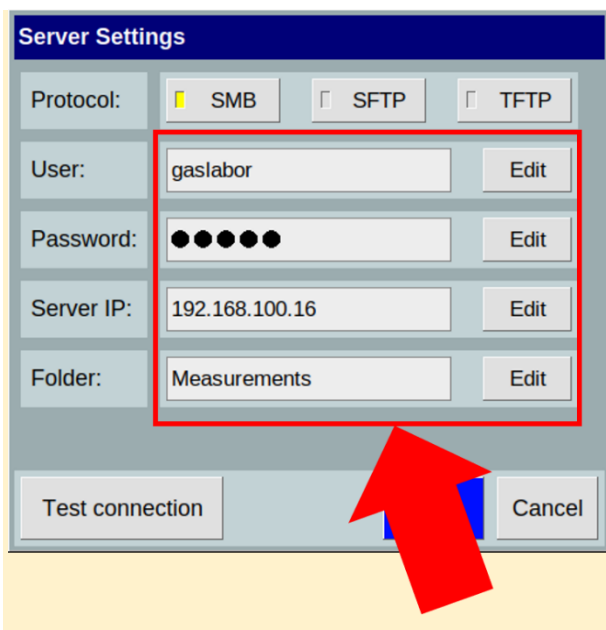

For **SMB** enter **Server IP Address**, **Folder** name, **User** name and **Password** for the SMB share on the server.

**7b**  
Option

**Server Settings**

Protocol:  SMB  SFTP  TFTP

User: gaslabor Edit

Password: ●●●●●● Edit

Server IP: 192.168.100.16 Edit

Port: 22 Edit

Test connection Cancel

For **SFTP** enter **Server IP Address**, **IP Port**, **User** name and **Password** for the SFTP server.

**7c**  
Option

**Server Settings**

Protocol:  SMB  SFTP  TFTP

Server IP: 192.168.100.16 Edit

Test connection Ok Cancel

For **TFTP** enter the **Server IP Address**.

**8**

**Server Settings**

Protocol:  SMB  SFTP  TFTP

Server IP: 192.168.100.16 Edit

Test connection Ok Cancel

Test the connection with **Test Connection**.



**INFORMATION!**

When the connection cannot be established check the Ethernet cable connection. Main the network IP address of the server, the used protocol, the name of the shared folder (**SMB**) on the server and the server account login data (**SMB**, **SFTP**). Consult the manuals of your server operating system and your system administrator.

9

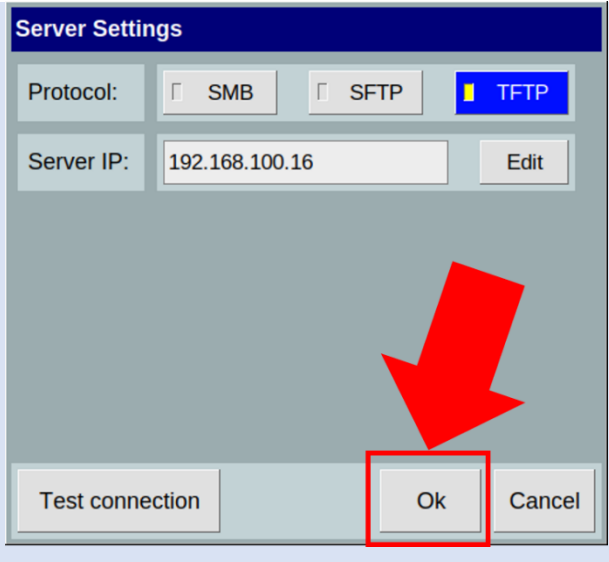

Close Dialog with **OK**.

### 9.16.3 Manual Transfer of measurement files to USB-Stick

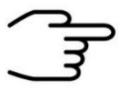

#### INFORMATION!

Do not turn off the device during the download process!

1

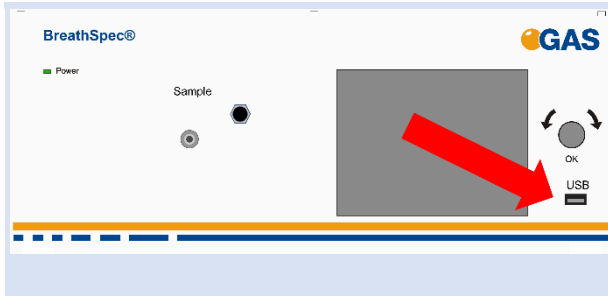

Connect the USB device (**FAT32**-formatted) to the **USB** socket at the front side of the housing.

2

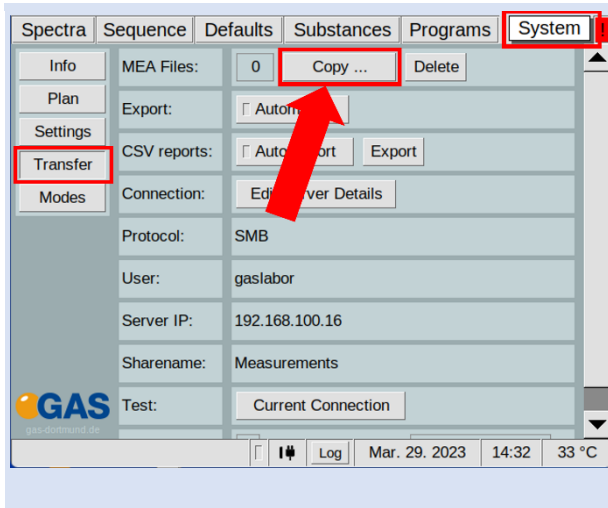

Open page: **System** > **Transfer**.

Press: **Copy USB**.

3

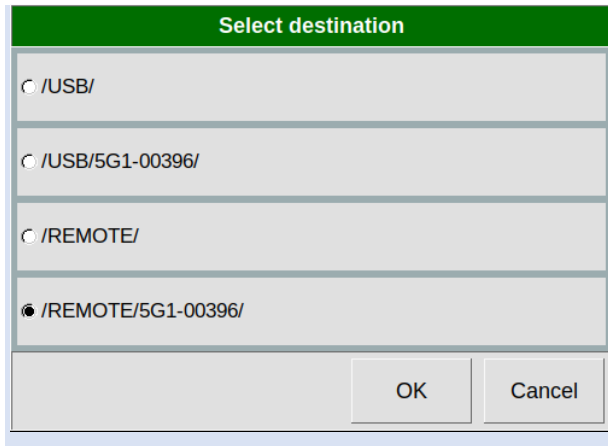

A confirmation dialog opens. Select the storage location (usb or remote)

Press **OK** to start the process.

4

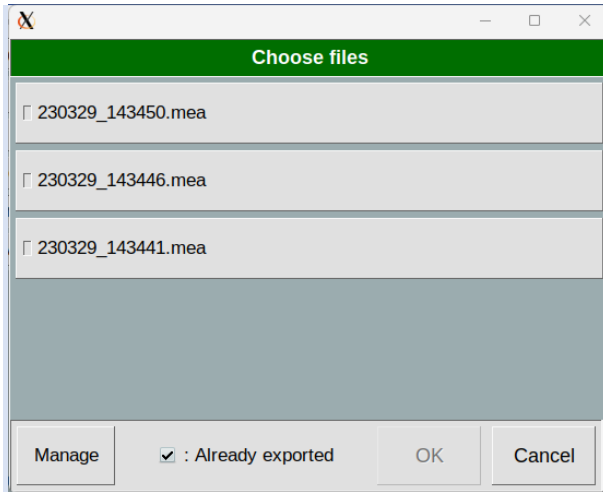

Select the files to be exported **manually** or use the **manage button** to select all.

5

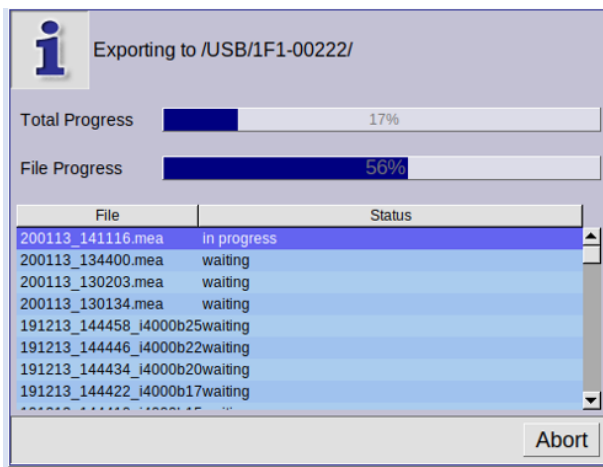

Wait until the exporting process is completed.

6a

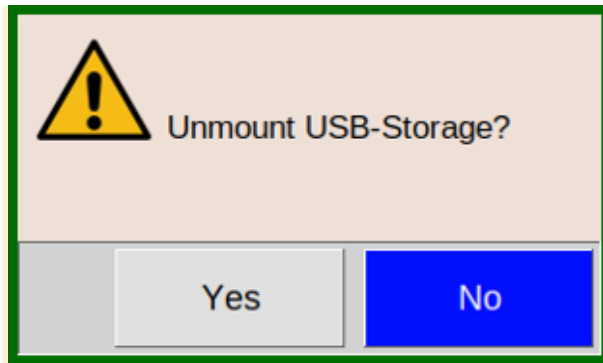

A confirmation dialog opens. Press **OK** to unmount the USB-Stick

6b

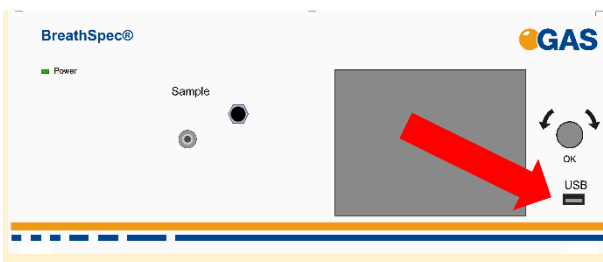

Remove the connected USB device from the **USB** socket at the front side of the housing.



The measurement files has been downloaded.

## 9.17 Current Loop Setup (only available in Version 5G2)

### 9.17.1 Introduction

The device writes the measured concentration of the main substance as electrical current to the 0-20 mA-current loop interface.

The concentration range of the output substance is mapped to a sub-interval within 0-20 mA.

Outside this sub-interval a mA-error value and a mA-idle value can be defined.

The error value is set when a measurement has failed to produce a valid concentration.

The idle value is set when no valid concentration is available yet or when the interval mode is not active.

### 9.17.2 Electrical Interface

The current loop must be connected to the **Signal Converter – I/O Ports** socket at the rear of the housing according to the following diagram:

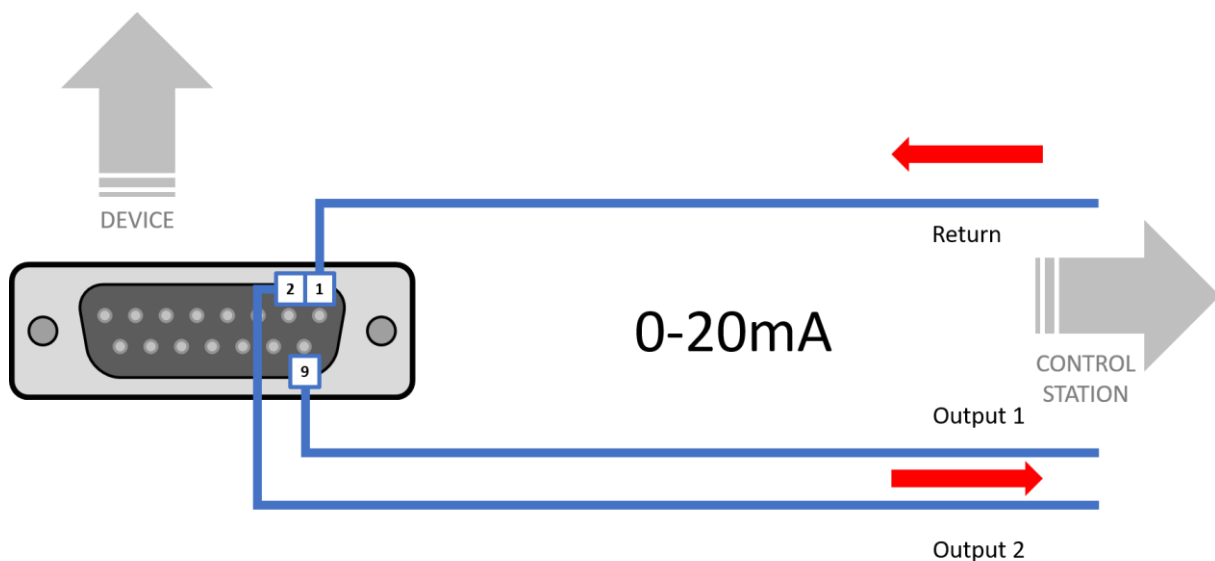

Figure 85: Schematics Current Loop

### 9.17.3 Configuring the Current Loop



**INFORMATION!**

For concentration value output through the 0-20mA current loop the socket **Signal Converter – I/O Ports** at the rear of the housing must be connected to an appropriate cable to a display unit.

**1a**

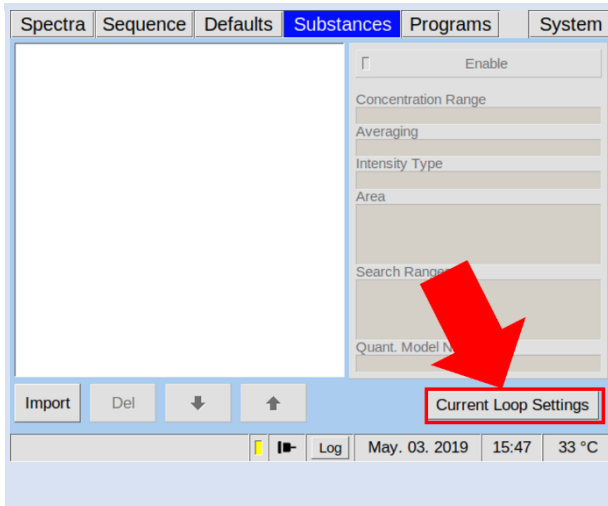

Open dialog:  
**Substances** > **Current Loop Settings**.

**1b**  
 Option

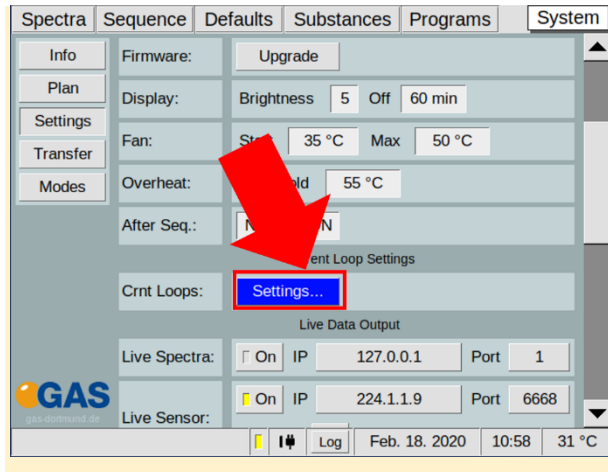

Optional open dialog:  
**System** > **Settings** > **Settings**.

**2**

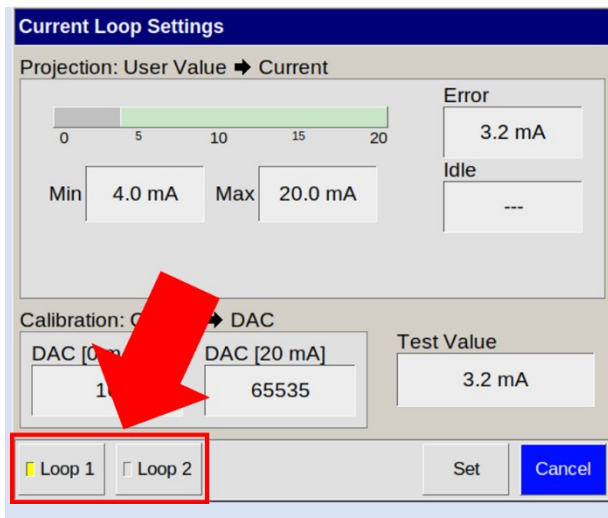

Select **Loop 1** or **Loop 2**.  
**Loop1**: Output of the first substance result.  
**Loop2**: Output of the second substance result.

**INFORMATION!**

Only two substance results can be transferred. These must be at the first and second position in the substance list.

**3**

**Current Loop Settings**

Projection: User Value → Current

0 5 10 15 20

Min 4.0 mA Max 20.0 mA

Error 3.2 mA

Idle ---

Calibration: Current → DAC

DAC [0 mA] 16 DAC [20 mA] 65535 Test Value 3.2 mA

Loop 1 Loop 2 Set Cancel

In **Projection: User Value** → **Current** set **Min** and **Max** value of the concentration range to the range 0 mA – 20 mA.

**4**

**Current Loop Settings**

Projection: User Value → Current

0 5 10 15 20

Min 4.0 mA Max 20.0

Error 3.2 mA

Idle ---

Calibration: Current → DAC

DAC [0 mA] 16 DAC [20 mA] 65535 Test Value 3.2 mA

Loop 1 Loop 2 Set Cancel

In **Calibration: Current -> DAC** set **DAC [0 mA]** and **DAC [20 mA]** calibrate to 0-20 mA by observing the outputted mA value on the external display unit. The values on the picture are examples. The values for DAC [0 mA] and DAC [20 mA] are preset by G.A.S. but **must be adapted by the user**.

**INFORMATION!**

The values for DAC [0 mA] and DAC [20 mA] are preset. The correct values for DAC [0 mA] and DAC [20 mA] must be adapted by the user.

5

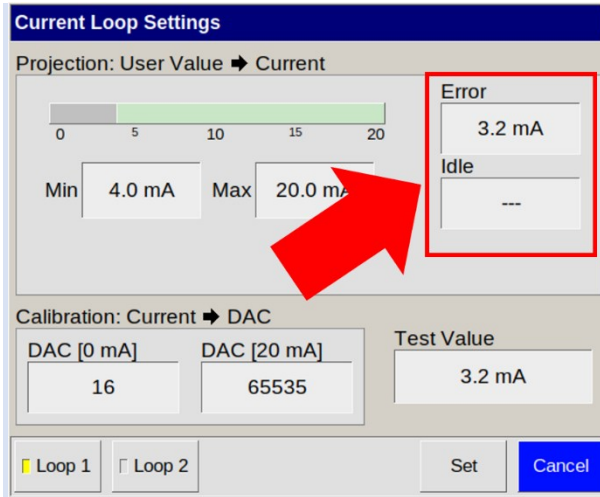

When desired set mA values for error and idle state with **Projection User Value -> Current Error** and **Idle**.

6

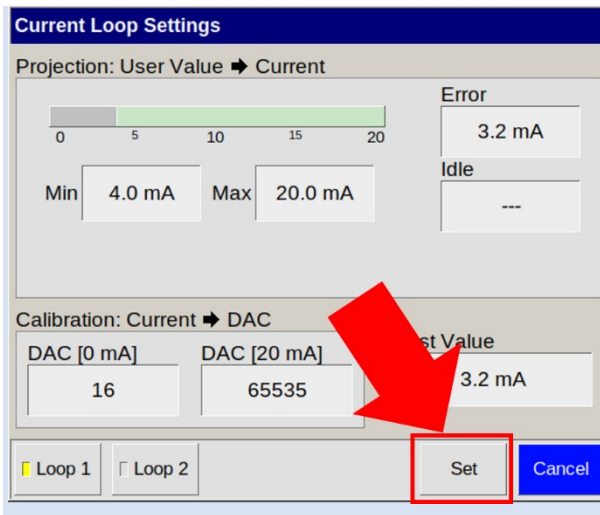

Close the dialog with **Set**.

## 9.18 Modbus TCP Setup

1

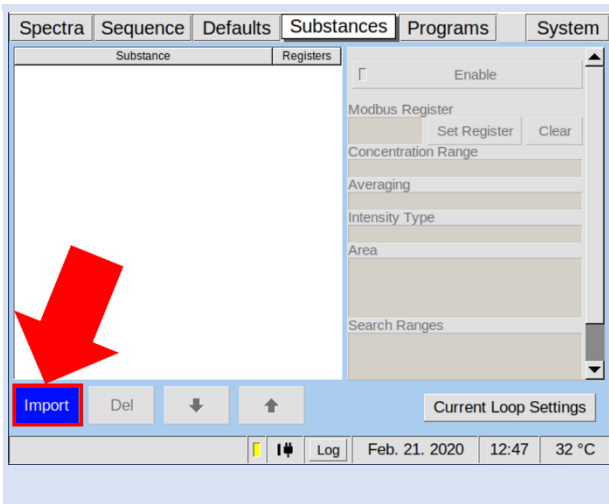

Open dialog:

**Substances** > **Import** to import a substance file list named **calibration.gsd**

2

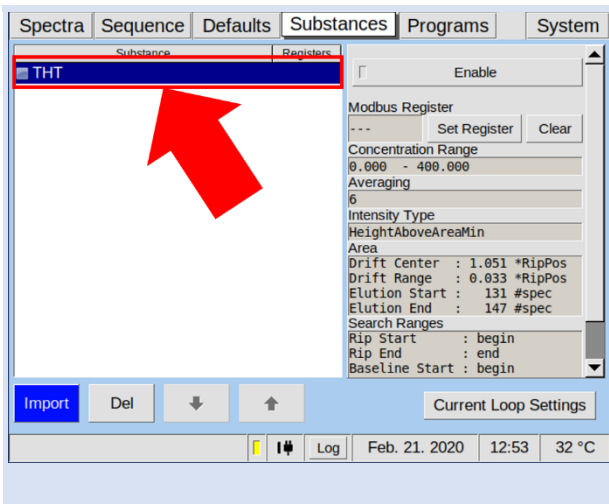

Select a Substance to setup the Modbus TCP register.

3

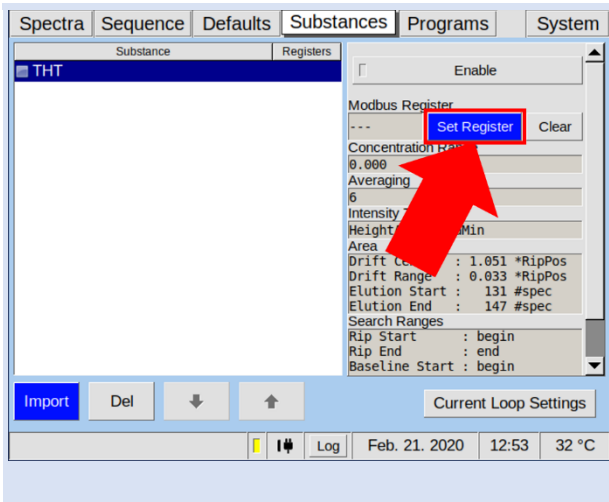

Select **Set register** to open the **Setup Dialog**.

4

Enter First Register(Total size will be 6)

Min: 7  
Max: 120

7 8 9  
4 5 6  
1 2 3  
0

Clear  
←

OK Cancel

In **Setup Dialog** enter the Register Values.

5

Spectra Sequence Defaults Substances Programs System

Substance	Registers
<input checked="" type="checkbox"/> THT	7-12

Enable

Modbus Register  
7 - 12 Set Register Clear

Concentration Range  
0.000 1000

Average  
6

Inter...  
HeightAl...  
Area

Drift Center : 1.051 \*RipPos  
Drift Range : 0.033 \*RipPos  
Elution Start : 131 #spec  
Elution End : 147 #spec

Search Ranges  
Rip Start : begin  
Rip End : end  
Baseline Start : begin

Import Del ↓ ↑ Current Loop Settings

Log Feb. 21. 2020 13:06 31 °C

In **Substances Window** the entered **Register range** is displayed.

## 9.19 Start Cleaning mode



### INFORMATION!

In case of contamination it is helpful to activate the cleaning mode to clean the system.

1

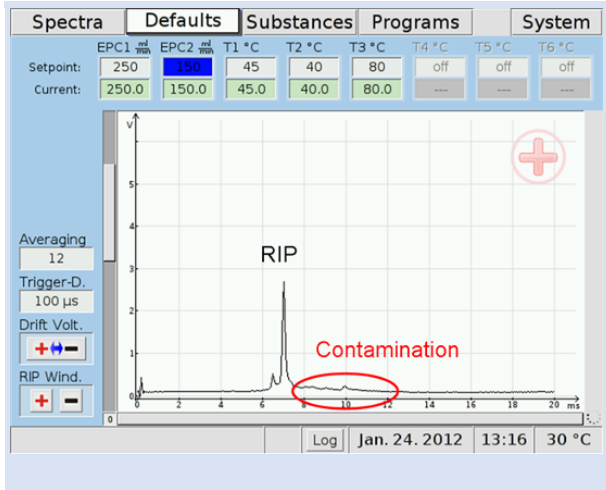

In case of contamination it is helpful to activate the cleaning mode to clean the system.

The frequency of cleaning interval is depending on the character and quantity of the samples.

2

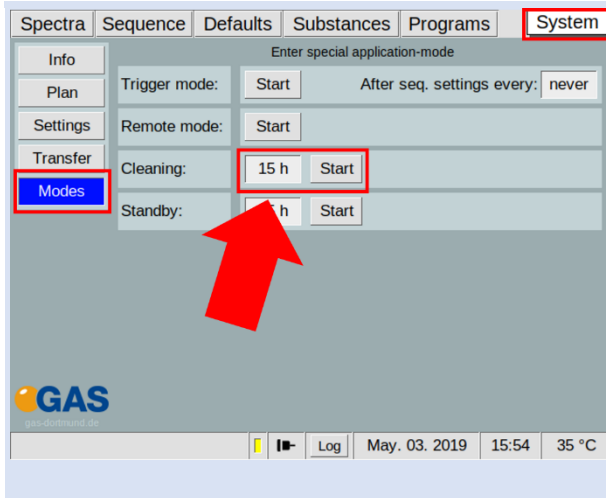

Select **System** > **Modes** > **Cleaning [x h]** and set the cleaning duration time.

Select **Start** to start the cleaning process.

All temperatures are set up to their maxima.

3

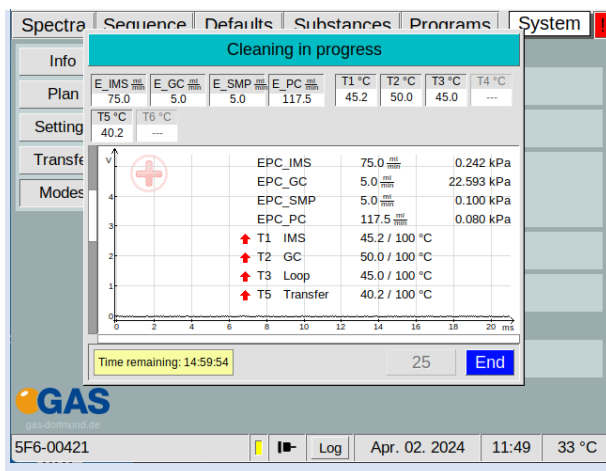

During the cleaning process a Cleaning window appears. During this process no other activities can be executed. This process can be skipped at any time.

## 9.20 Start Standby mode



### INFORMATION!

It is recommended not to switch off the device during measurement breaks. Using the Standby mode ensures the cleanness of the system and a quick readiness to measure and helps saving Nitrogen.

1

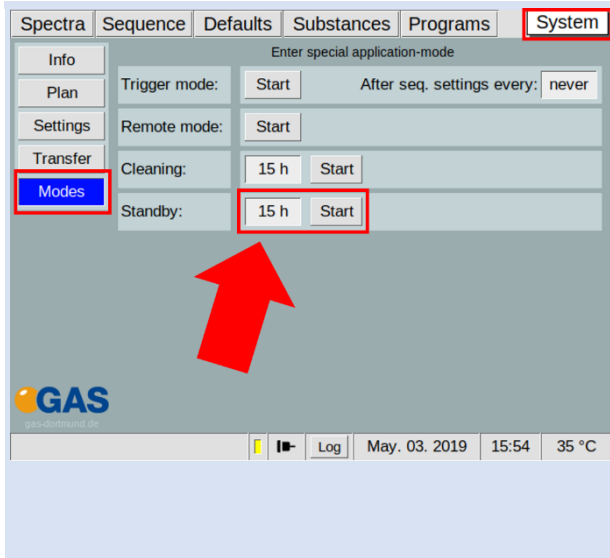

Select **System** > **Modes** > **Standby [x h]** and set the standby duration time.

Select **Start** to start the Standby process.

Driftgas (EPC\_IMS) is set to **10 ml/min** and Carriergas (EPC\_GC) is set to **5 ml/min**.

2

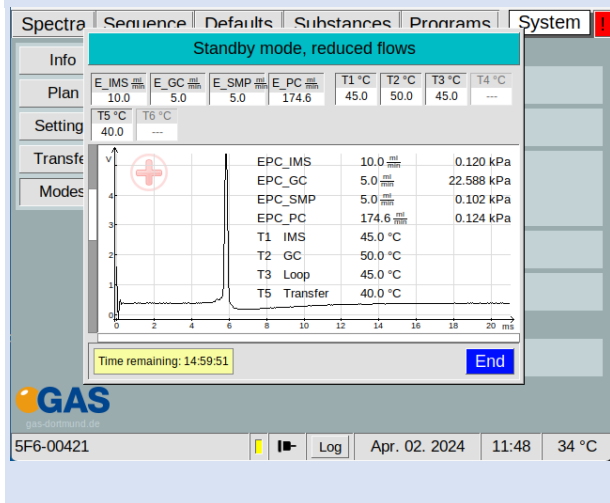

During the standby process a Standby Window appears. During this process no other activities can be executed. This process can be skipped at any time.

## 9.21 Remove the Housing Cover



### DANGER!

Before all work on the device switch off the device and pull out the power plug!

1



Switch off the device and pull out the power plug.

2a



Open the side-covers of the case carefully using a screwdriver.

2b



Remove the side-covers of the case carefully

**2c**

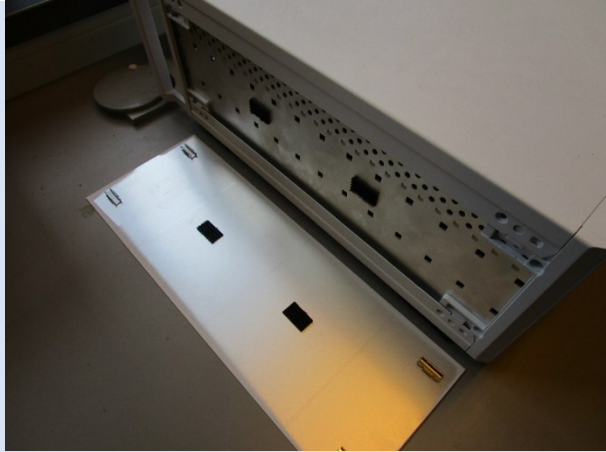

Removed side-cover.

**3a**

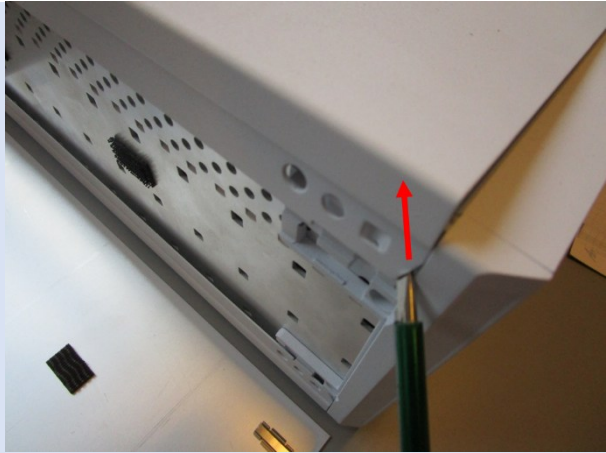

Open the top-cover of the case carefully using a screwdriver.

**3b**

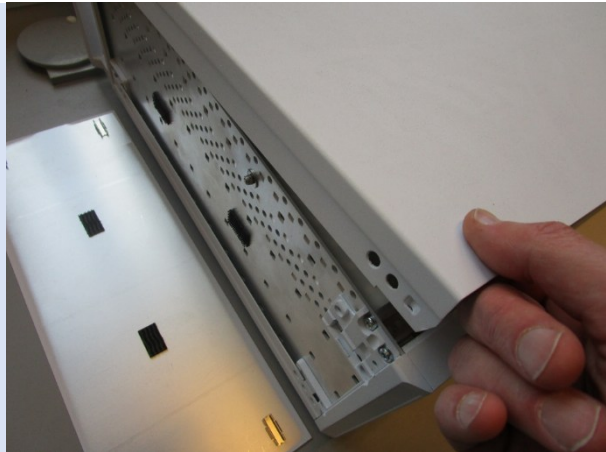

Remove the top-cover of the case carefully.

4



Device without top cover.

## 9.22 Change Capillary Column



### DANGER!

Before all work on the device switch off the device and pull out the power plug!

1

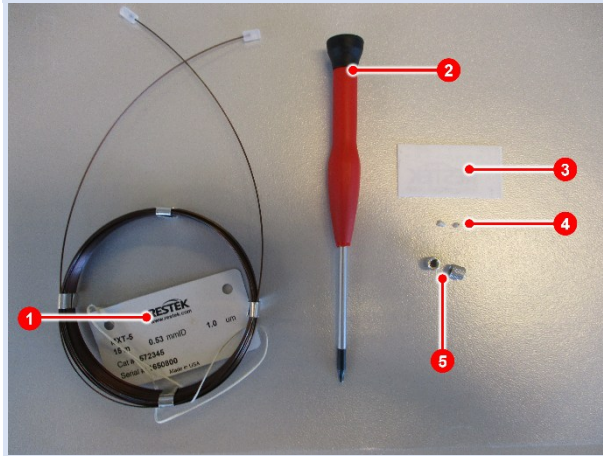

### Necessary tools:

1. Capillary column
2. T10 Torx screwdriver
3. Column cutter
4. Peek Ferrule with hole (depending on the column dimensions)
5. Handtight screw connector

2



Switch off the device and pull out the power plug.

3

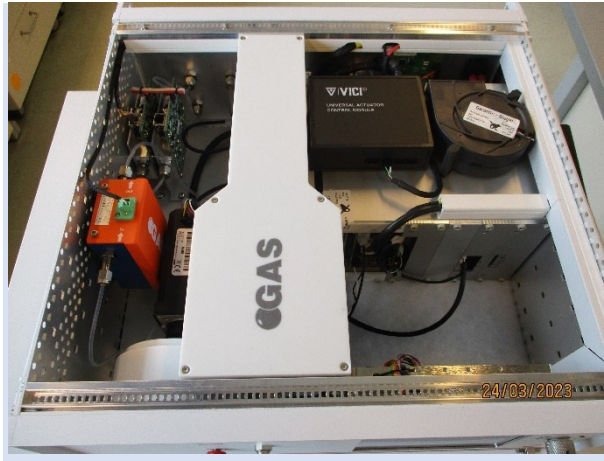

Remove the top cover.  
For detailed information see [Chapter 9.21 Remove Housing Cover](#)

4

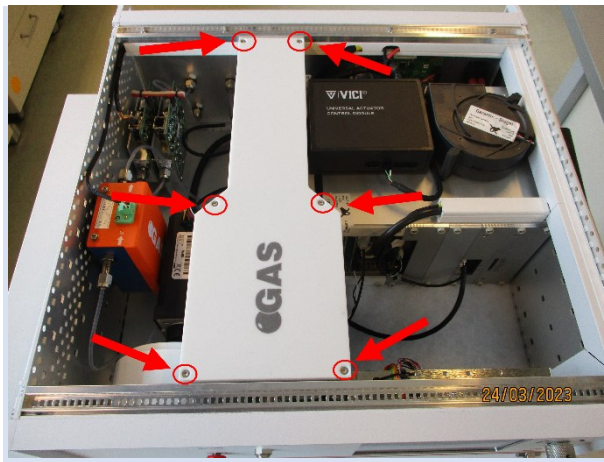

Release all screw of the oven-cover and remove it.

5

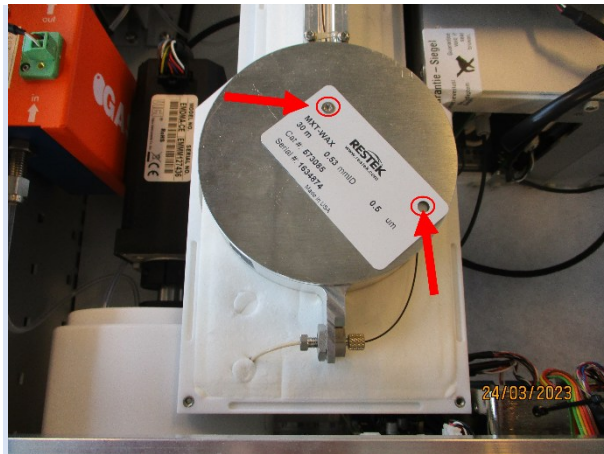

Release all screw of the inner oven-cover and remove it.

6

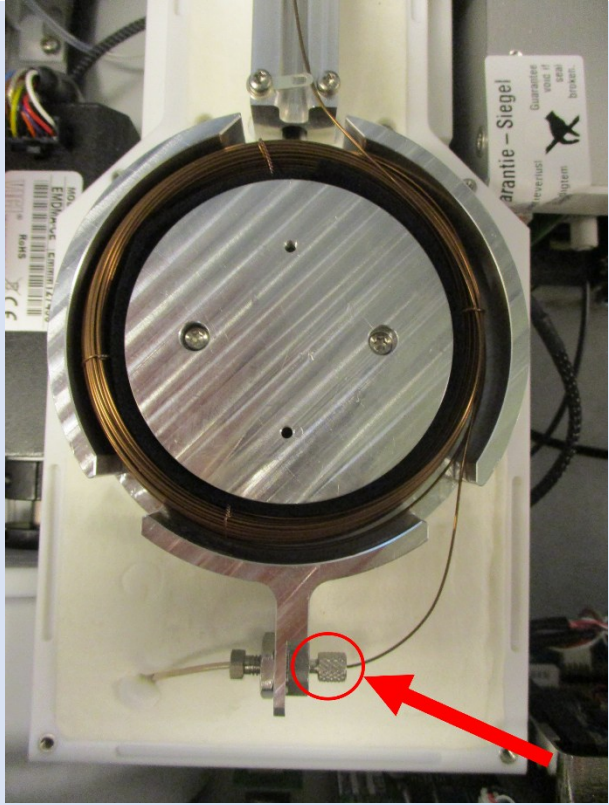

Open the front handtight screw-connector.

7

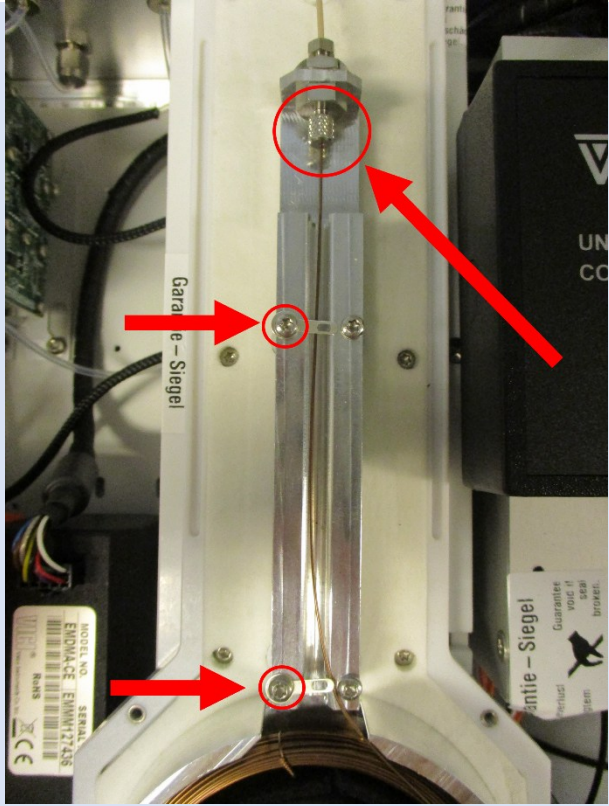

Open the rear handtight screw-connector.  
Also open the transfer line securing holder.  
Remove the capillary column.

8

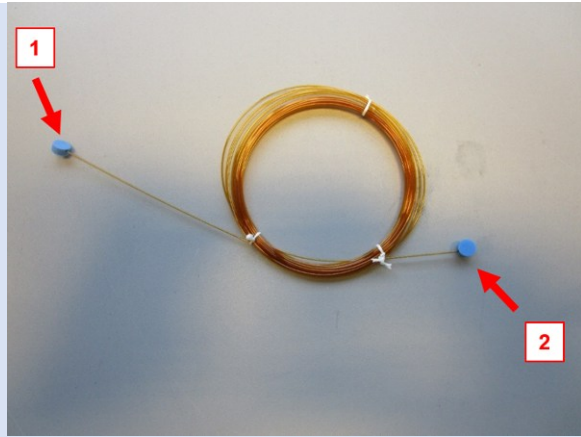

Remove the blind bolts (1) + (2) of the capillary column

9

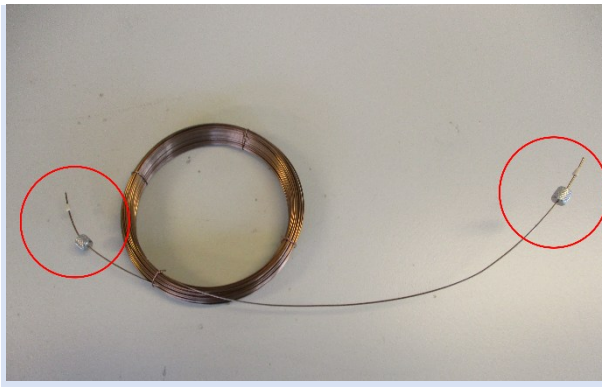

Insert the handtight screw-connector and the Peek-ferrules with hole.

10

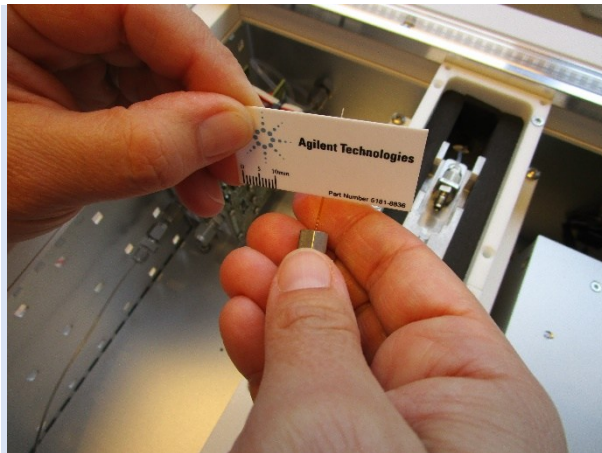

Put the new capillary column into the oven. If necessary, cut the ends of the column.

11

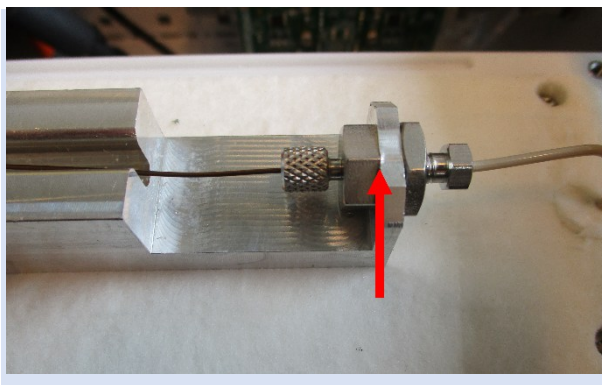

Max installation length of the column.

Shorten the column to this position

12

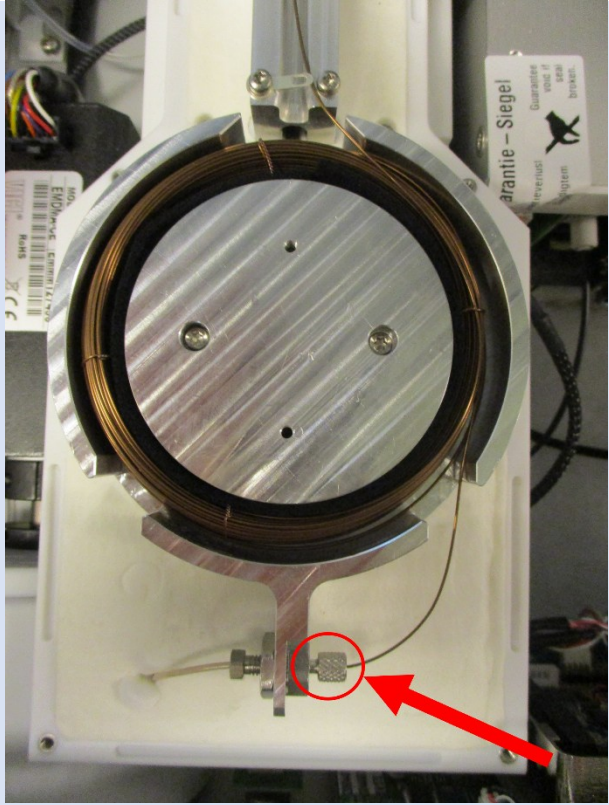

Connect the column with the front handtight screw-connector.

13

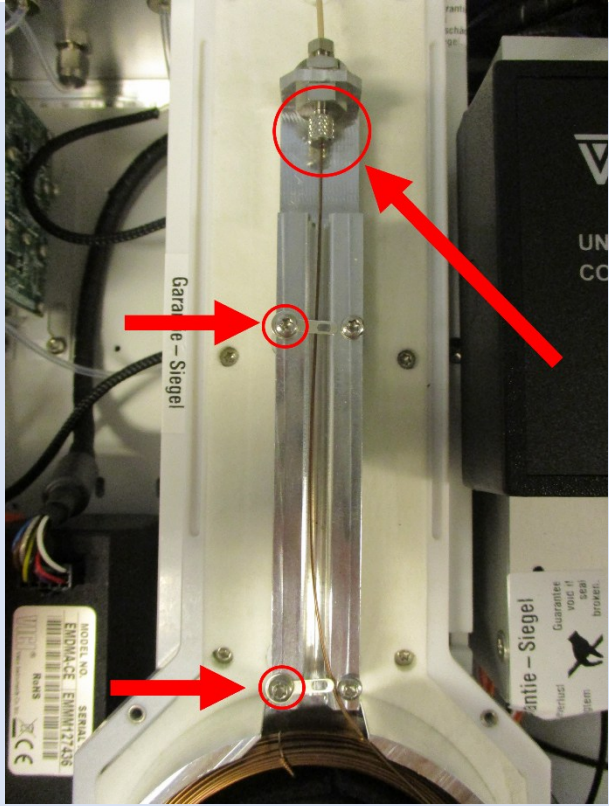

Connect the column with the rear handtight screw-connector.  
Also close the transfer-line securing holder.

14

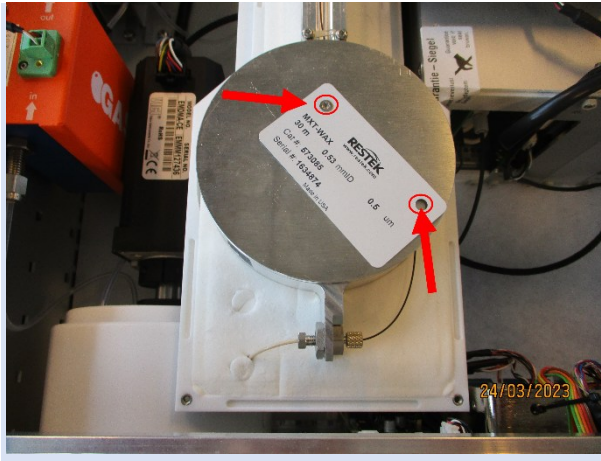

Mount the screws of the inner oven cover. Make sure that the column labeling is screwed on.

15

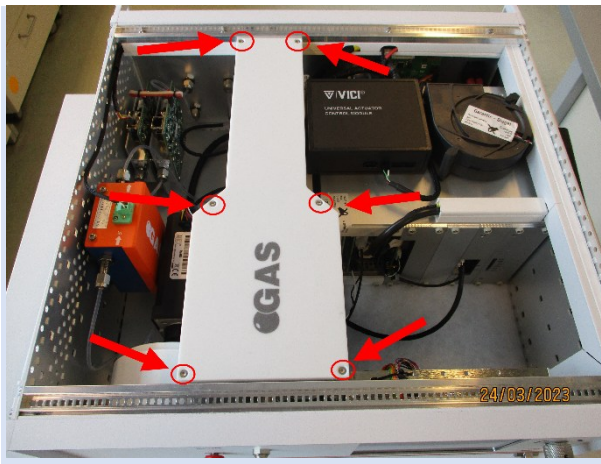

Mount the screw of the oven cover.

Attach the top cover, the bottom cover and the side cover.

Install all connections and switch on the device.

## 9.23 Change sample pump unit



### INFORMATION!

Only authorized, trained and technically instructed people are allowed to do these work steps.



### DANGER!

Before all work on the device **switch off the device** and **pull out the power plug!**

1



Switch off the device and pull out the power plug.

2



Remove the top cover.  
For detailed information see **Chapter 9.21 Remove Housing Cover**

3

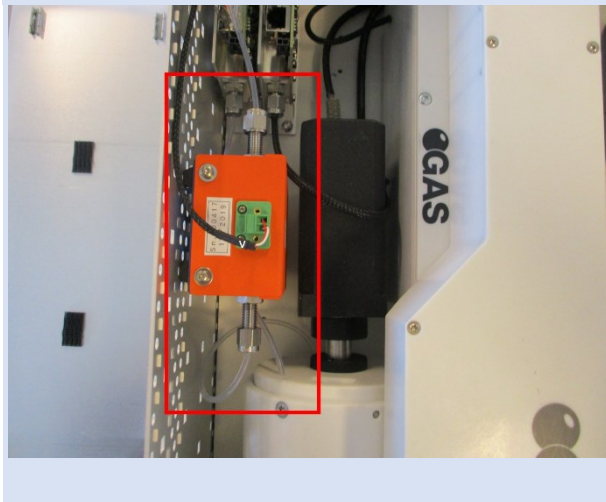

Top view of installed sample pump unit.

4

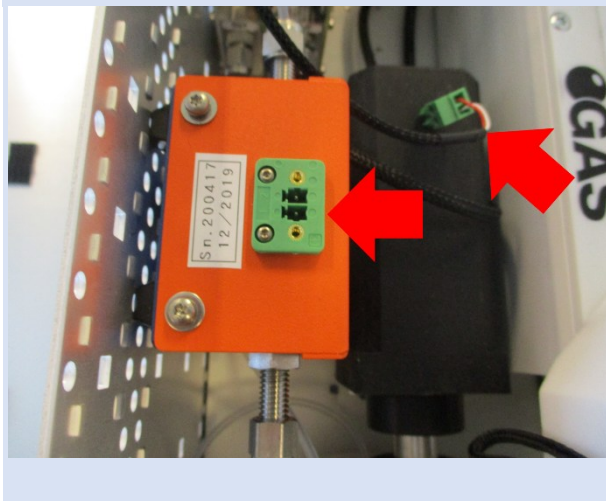

Remove the plug.

5

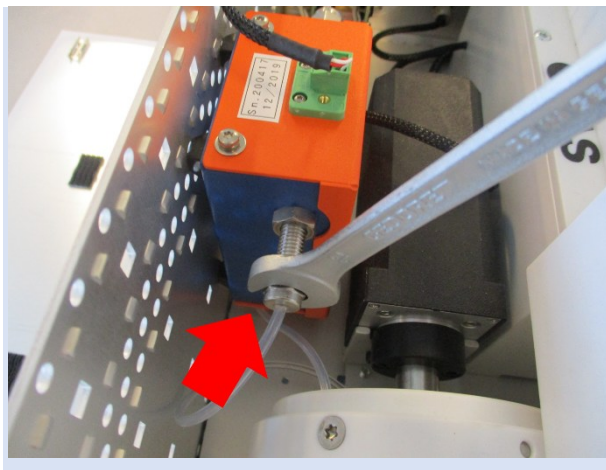

Loosen front connector.

6

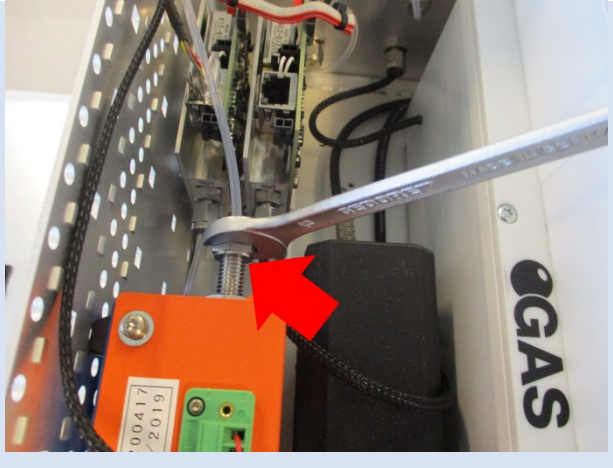

Loosen rear connector.

7

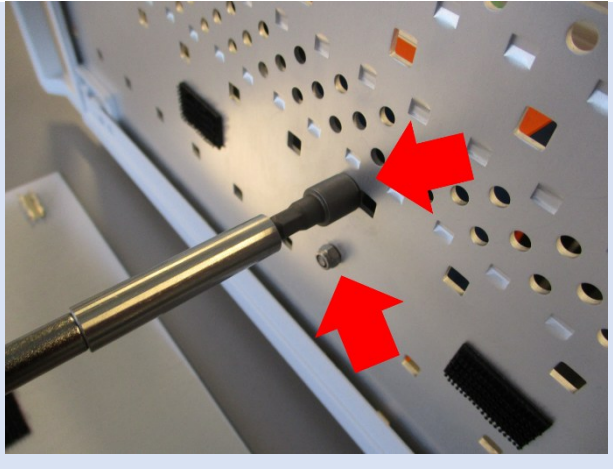

Loosen the fixing screws and remove the sample pump unit.

8

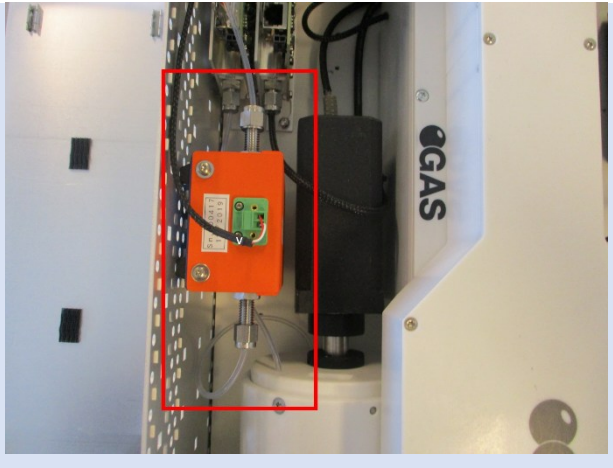

Insert a new sample pump unit and mount it in reverse order.

## 9.24 Change high voltage circuit board



### INFORMATION!

Only authorized, trained and technically instructed people are allowed to do these work steps.



### DANGER!

Before all work on the device **switch off the device** and **pull out the power plug!**

1



Switch off the device and pull out the power plug.

2

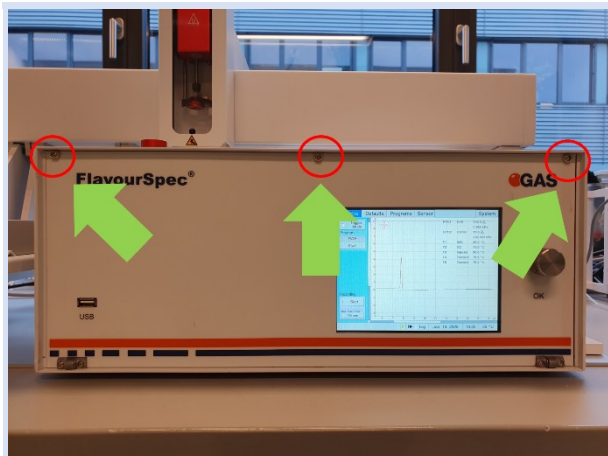

Loosen three Screws at the front of the device.

3



Remove the top cover.  
For detailed information see [Chapter 9.21](#)  
**Remove Housing Cover**

4

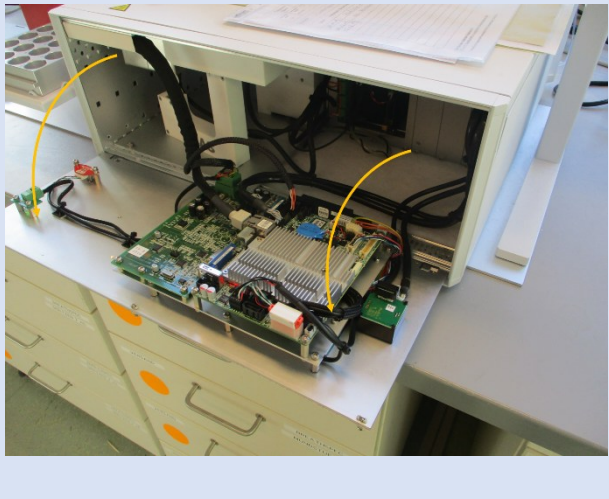

Open the front panel.

5

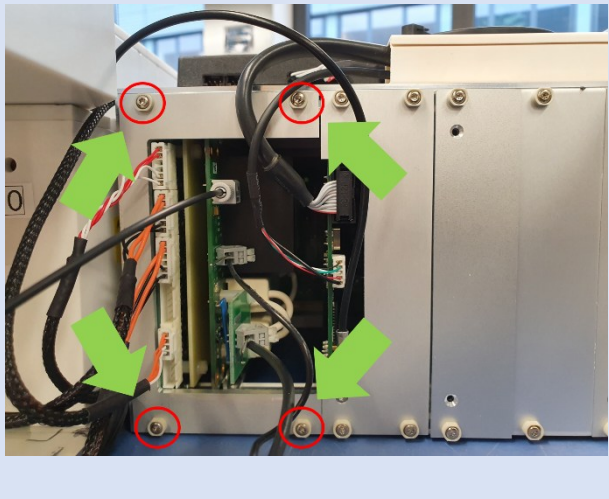

Loosen four screws with T8 screwdriver and remove the coverplate.

6

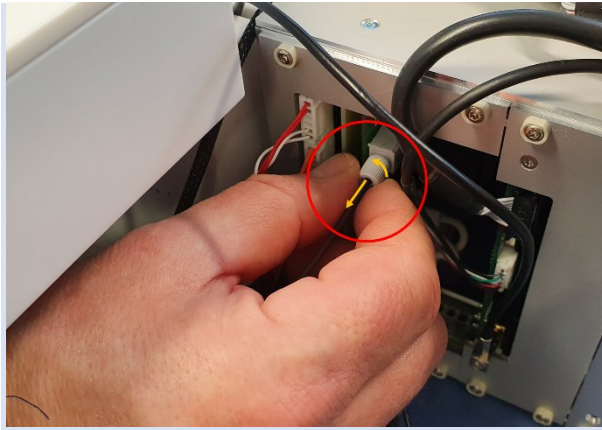

Loosen the nut from transmitter and pull-out fibre-optical-cable.

7

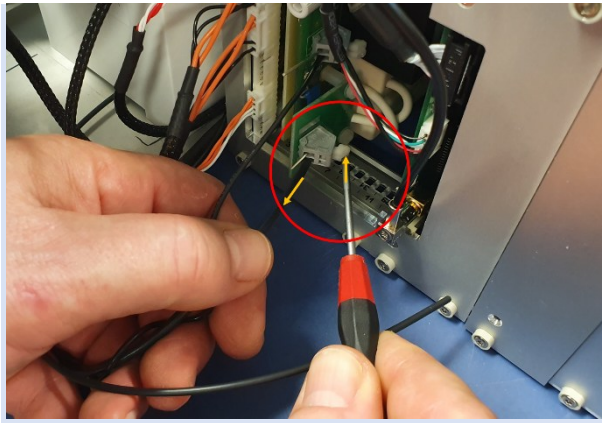

Push the button and pull-out high voltage wire

8

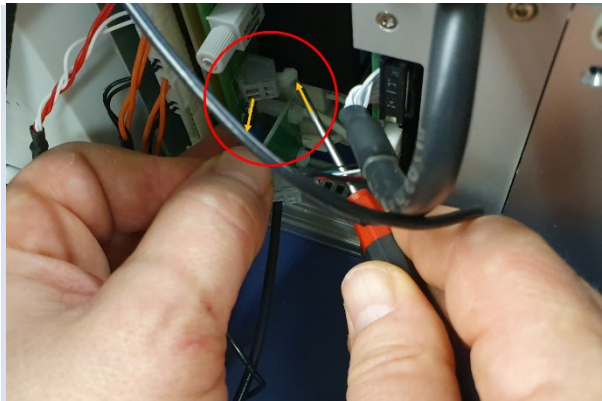

Push the button and pull-out ground wire

9



Pull the circuit board out of the casing profile

10



Insert the new circuit board

11

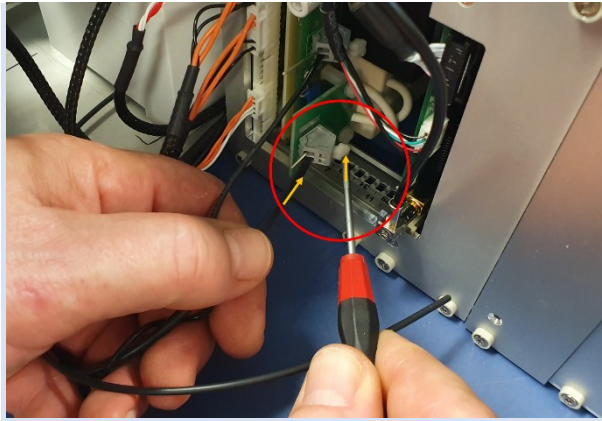

Push the button and reinsert the ground wire

12

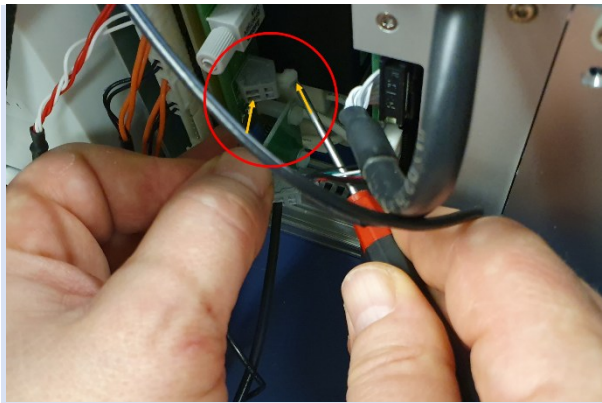

Push the button and reinsert the high voltage wire

13

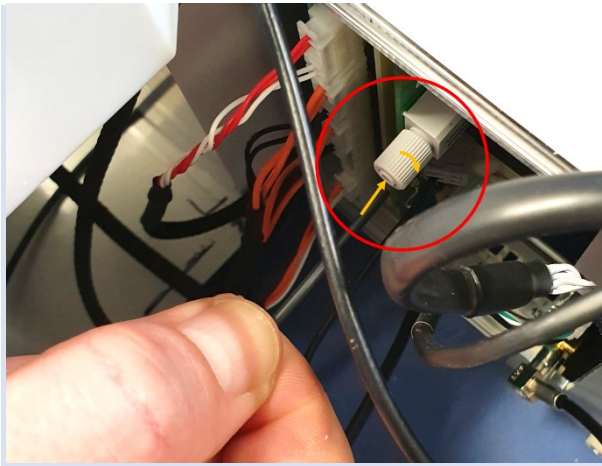

Reinsert the optical fiber cable and tighten the screw connection.

14

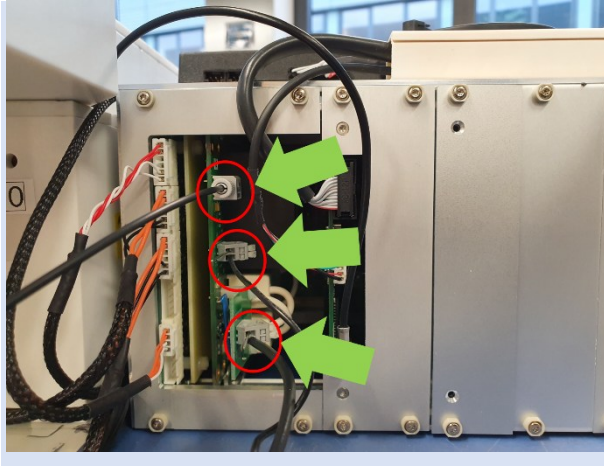

View of the three connected wires.

15

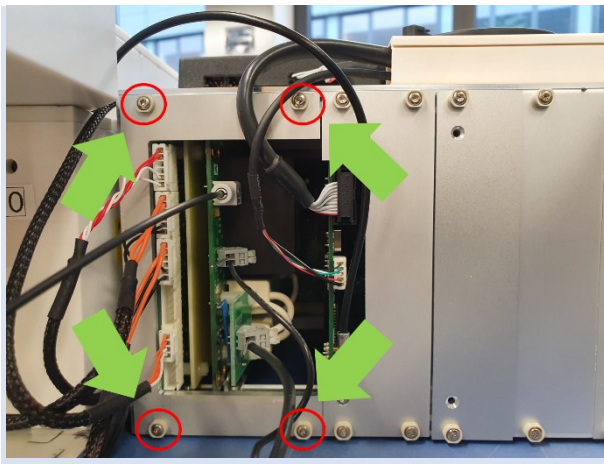

Replace the cover plate and tighten the four screws.

16

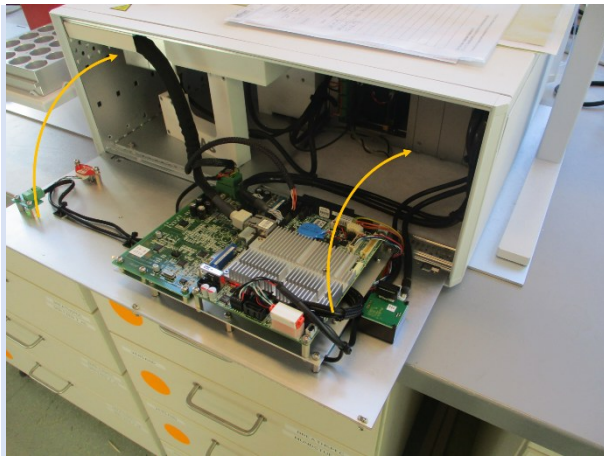

Close the front plate and attach the top cover.

17

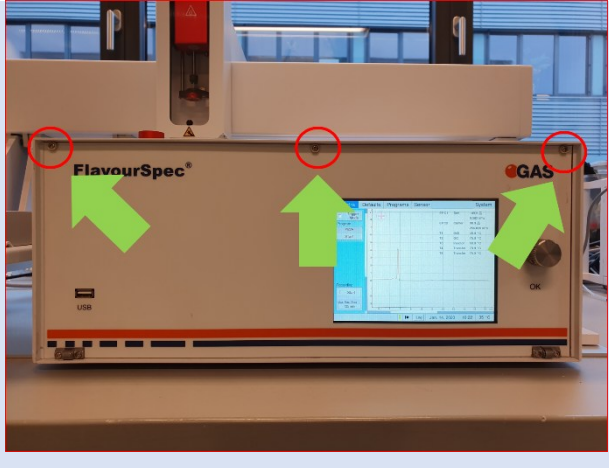

Tighten the three screws of the frontplate.

## 9.25 Change filter set CGFU



### INFORMATION!

It is recommended change the filter set of the Circular gas flow unit periodically. The recommended maintenance interval is every **6 months**.



### DANGER!

Before all work on the device switch off the device and pull out the power plug!

1



Switch off the device and pull out the power plug.

2



Remove the side-covers of the CGFU-case carefully with a small screwdriver and remove the cover.

3

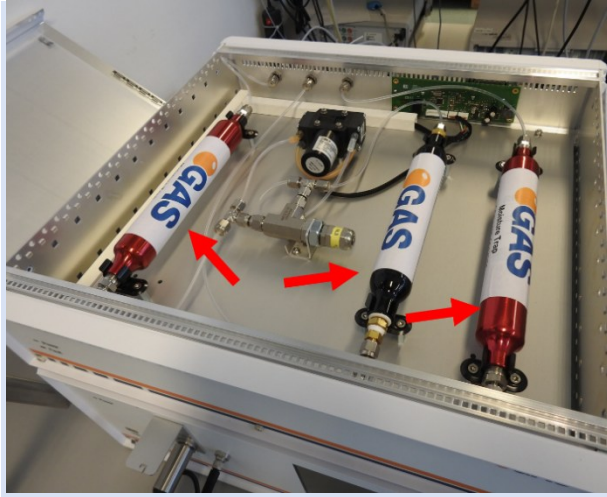

The two molecular sieve cartridges (Red) and the activated carbon cartridge (Black) must be replaced periodically **every 6 months**.

4

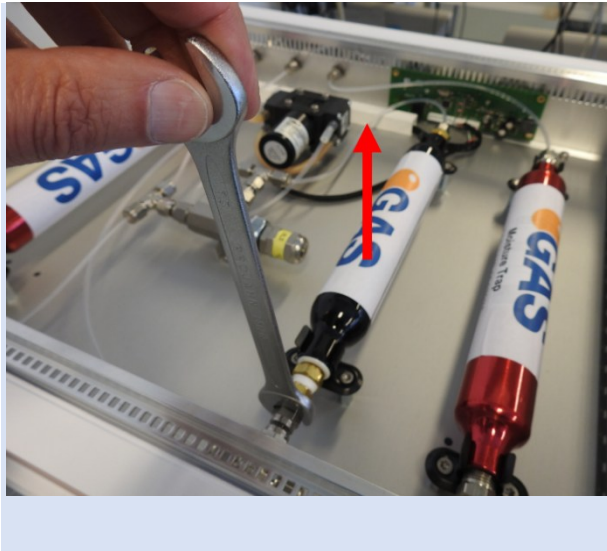

Loosen the connectors with a spanner and remove the cartridges in upwards direction.

5

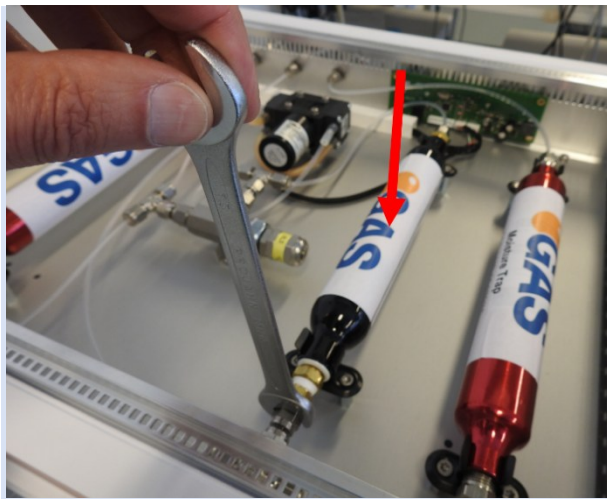

Insert a new cartridge into their clips and tighten the connector screws.

6



Attach the top cover.  
Connect the power plug  
and switch on the device.

### 9.26 Firmware Upgrade

The firmware of G.A.S. IMS devices can be upgraded by the user with an **update.gas file** – provided by G.A.S. The file name must start with update and end with .gas.

This file must be put on an empty USB storage device (e.g. 'USB stick' / 'USB thumb drive') formatted as a FAT32 file system.



#### INFORMATION!

The USB storage device must be formatted to FAT32. Consult your system administrator on formatting USB devices.



#### INFORMATION!

Do not turn off the device during the upgrade process!

1

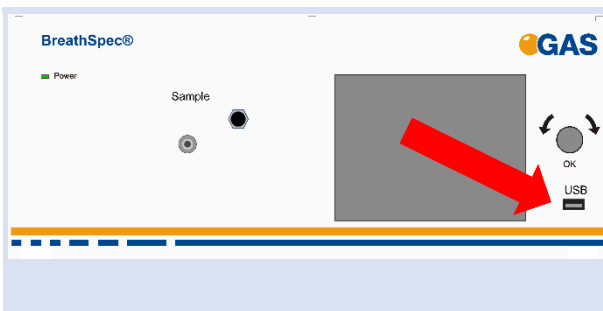

Connect the **USB device** (**FAT32-formatted**) with the upgrade file - provided by G.A.S. to the **USB socket** at the front side of the housing.

2

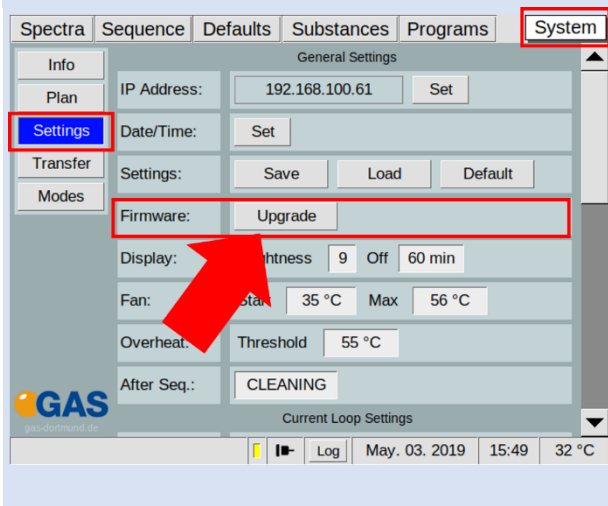

Open page:  
**System** > **Settings**.

Press:  
**Firmware** > **Upgrade**.

3

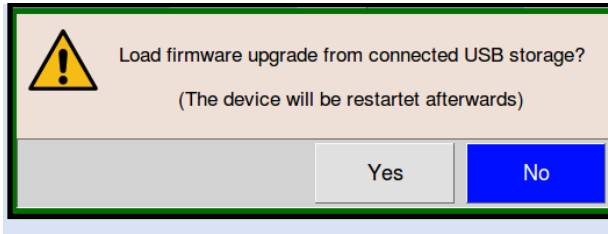

A confirmation dialog opens.

Press **Yes** to start the process.



**INFORMATION!**

Do not turn off the device during the upgrade process!  
Do not remove the USB device!

The upgrade process will take one minute or more depending on the tasks that are performed during the process.

4



Wait until the process is completed and a system restart dialog opens.

5

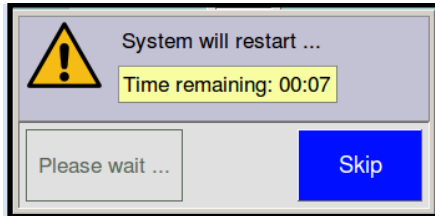

Wait for the device to restart or press **Skip** to restart the device immediately.

6

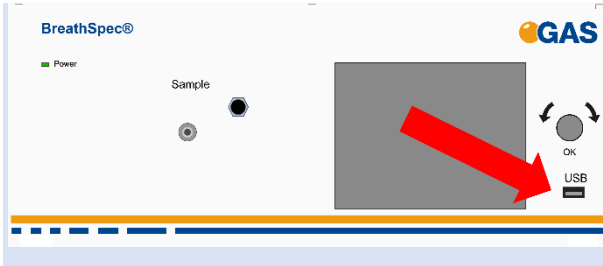

**Now:**  
Remove the connected USB device from the **USB** socket at the front side of the housing.

7



Wait until the device has started and the user interface is visible on the screen.

8

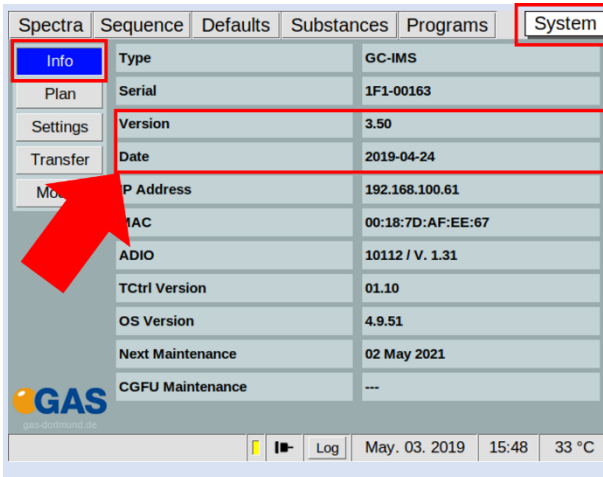

Open page: **System** > **Info**.  
Verify that the new firmware version has been installed.



**The device firmware has been upgraded.**

9.27 Creating diagnostic information for support



**INFORMATION!**  
The following steps are necessary to compile the required diagnostic information. Please stick on consecution as listed below.

**1**



Take a picture of the instrument label on the rear side.

**2**



Switch on the device. Power LED front and switch (rear) have to be illuminated.

3

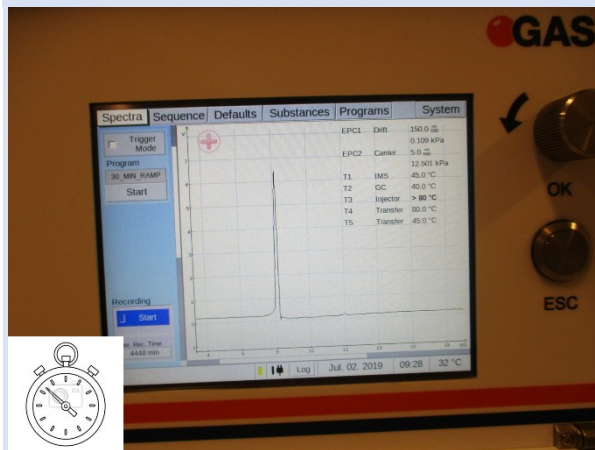

Record how long it takes to boot up and to display of GUI in seconds. In case of error take a photo of the display.

4



Insert a **FAT32 formatted USB-stick** into the **USB slot** at the front of the device.

5

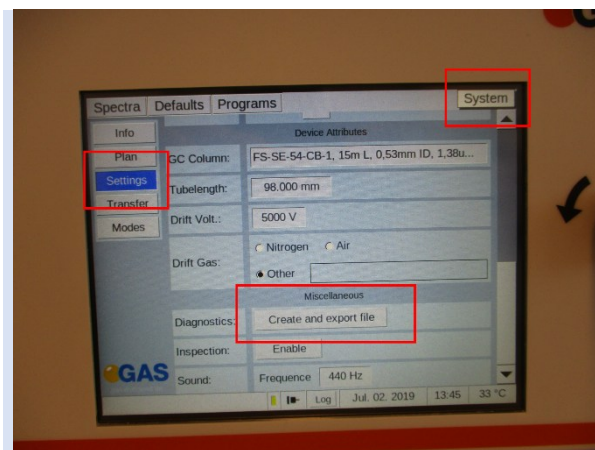

In **System Window** > **Transfer** select Settings and start the diagnostic file compilation by selecting the **Create and Import file Button**.

6

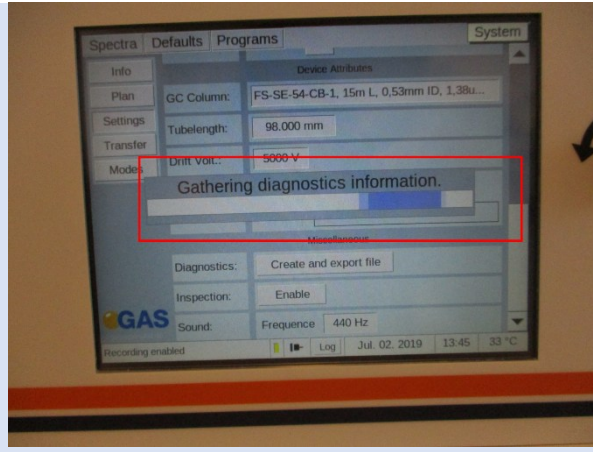

The diagnostic file is created.

7

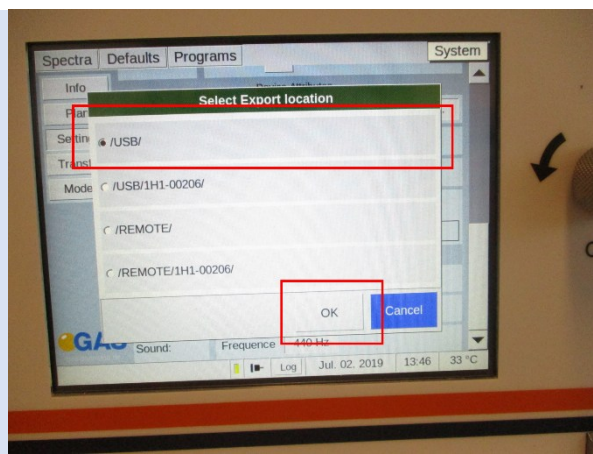

Select Export Location /USB/ and press **OK**.

8

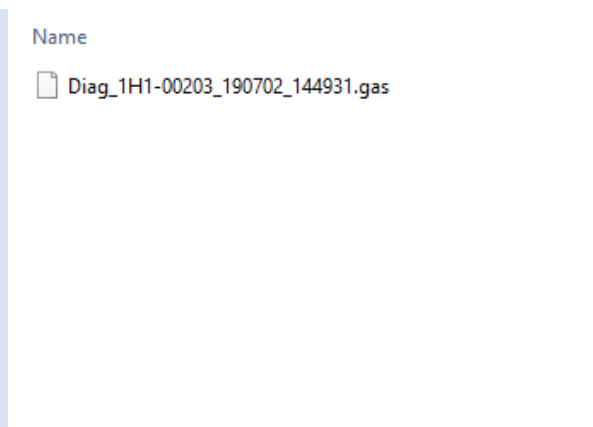

Send the **diagnostic file** and the **photos** taken by user by data transfer to [support@gas-dortmund.de](mailto:support@gas-dortmund.de)

## 9.28 Packing for return transport

Before packing make sure that the device fulfils the decontamination requirements



### INFORMATION!

It is recommended to **use the original transport box** for a safe return transport.



### INFORMATION!

It is recommended to **to send the transport box on pallet** for a safe return transport.

1

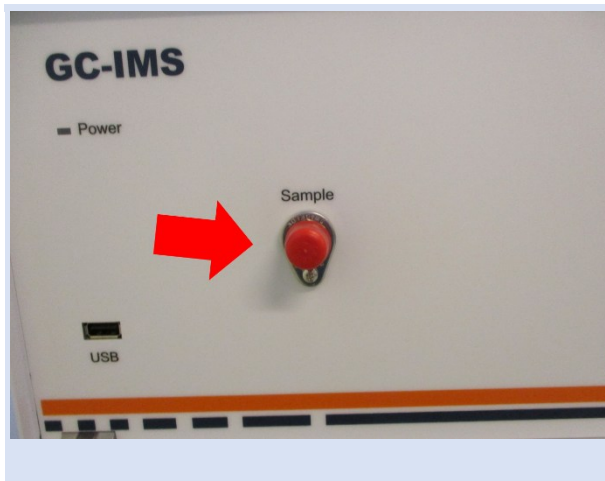

Close all gas connections with the red caps on the front side of the device.

2

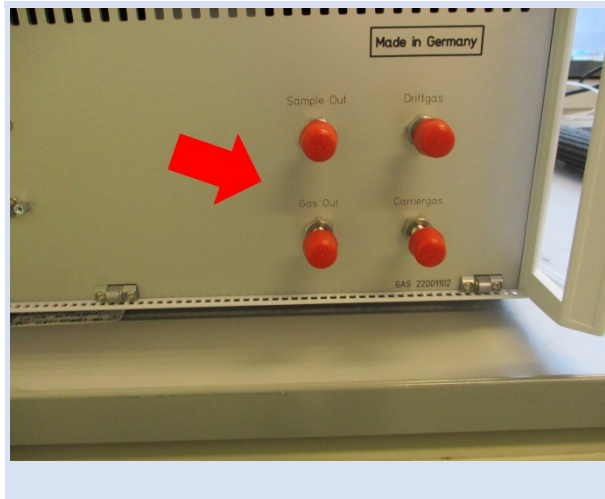

Close all gas connections with the red caps on the rear side of the device.

3

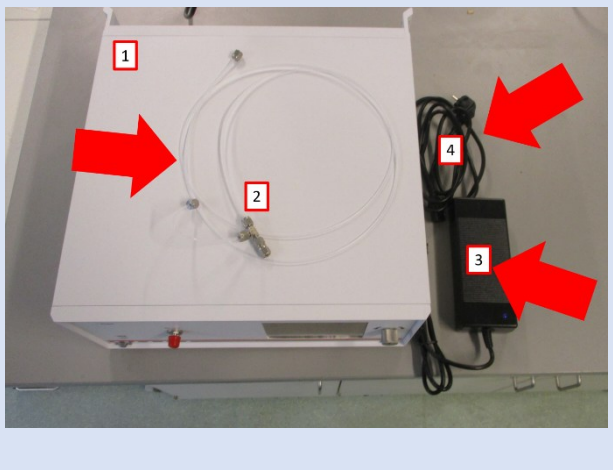

Minimum scope of delivery for the return transport:  
Device 1, Hoses 2, power supply 3 and plug 4

4



It is recommended to return the system in the original box and on palett.  
Further accessories can be supplied optionally.

## 9.29 Manual modification of the sample description attribute.

The attribute sample description can be changed manually in the measurement file. For this purpose a text editor is required, e.g. the free editor **Notepad++** [<https://notepad-plus-plus.org/>].



### INFORMATION!

Only authorized, trained and technically instructed people are allowed to do these work steps. Please contact us in any case before you start working.

Only use the recommended text editor notepad++ [<https://notepad-plus-plus.org/>].

Wrong input can corrupt the measurement file.

Only work with a copy of the measurement file.

# 1

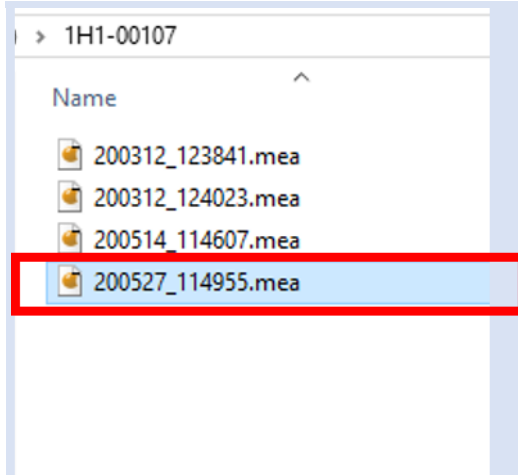

In windows explorer **select a copy** of the measurement file.

2

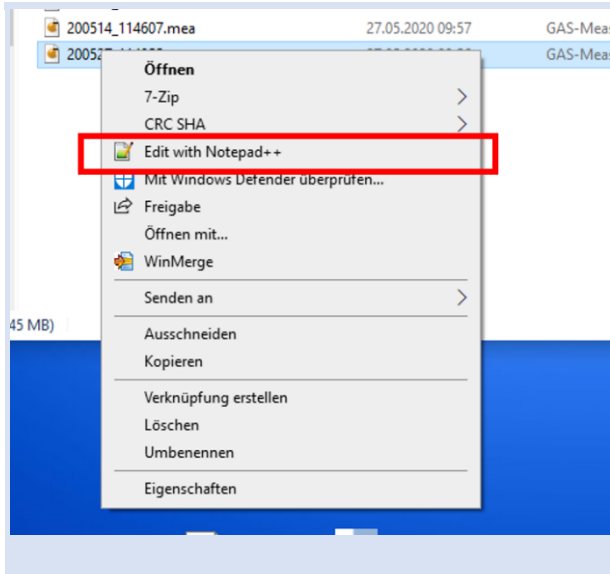

With **right click** on measurement file select **Edit with Notepad++**.

3

```
17 EPC1 pressure = 0.000 [kPa]
18 EPC2 end-pressure = 97.160 [kPa]
19 EPC2 pressure = 87.794 [kPa]
20 Filter = "SG8"
21 Firmware date = "2020-01-28"
22 Firmware version = "3.59"
23 Flow Epc 1 = "1500 1500 1497 1500 1500"
24 Flow Epc 2 = "443 500 500 500 500 500 500"
25 Flow record interval = 18000 [ms]
26 Flow1 setpoint = 150.0 [ml/min]
27 Flow2 setpoint = 50.0 [ml/min]
28 GC Column = "MXT-5, 15m L, 0,53mm ID, ..."
29 Machine name = "GAScontrol"
30 Machine serial = "1H1-00226"
31 Machine type = "FlavourSpec®"
32 nom Drift Potential Difference = 5000 [V]
33 nom Drift Tube Length = 98000 [µm]
34 Pressure Ambient = "99943 99942 99942 99942 9"
35 Pressure Epc 1 = "805 812 809 809 810 809 8"
36 Pressure Epc 2 = "87794 97152 96983 97156 9"
37 Pressure record interval = 18000 [ms]
38 Program = "Name= `30_min (Avges=6)Pas"
39 Sample = "mea 2"
40 Sensor block = 100 [dgt]
41 Sensor data = "00050109, 01/2020, 10347"
42 Sensor drift = 240 [dgt]
43 Sensor inject = 2500 [dgt]
```

In the opened measurement file find the attribute **Sample**.

4

```
Pressure record interval = 18000 [ms]
Program = "Name= `30_min (Avges=6)Pas"
Sample = "mea 2"
Sensor block = 100 [dgt]
Sensor data = "00050109, 01/2020, 10347"
Sensor drift = 240 [dgt]
```

Change sample description **(Entry between the quotation marks)**.

**Save the measurement file.**

### 9.30 Sample line rinsing (optional)



#### INFORMATION!

To avoid contamination from the ambient air, it is recommended to flush the sample line continuously. This will also allow to record a true system measurement.

Therefore the device working-gas exhaust is connected to the sample inlet via bypass. Do not apply when the device is heavily contaminated

Connect the stopcock only during the system idle phase. For measurement disconnect the stopcock and reconnect after sampling.

**1**

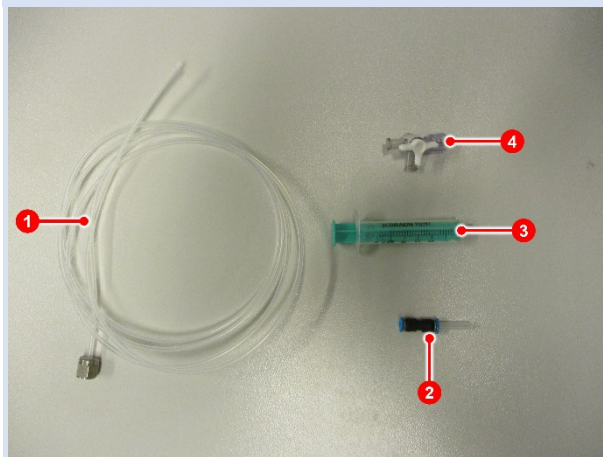

#### Required accessories

- 1** Gas out tube
- 2** Festo-Adapter 3 to 4 mm with 4 mm tube
- 3** disposable syringe
- 4** 3-Way-Stopcock with Luer-Lock-Adapter

**2**



Connect the syringe body and a 4 mm tube with Festo adapter to the 3-way stopcock.

3

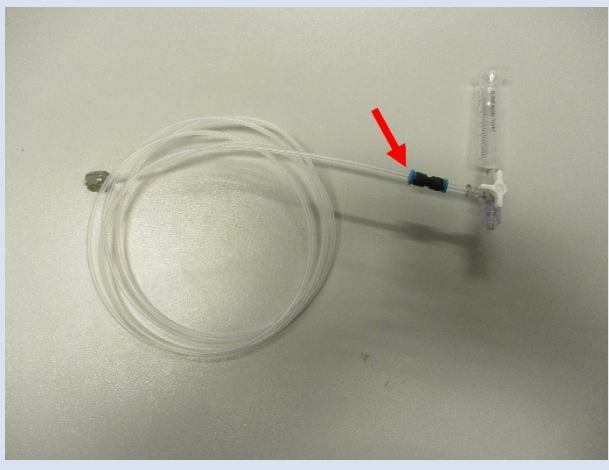

Connect the 3 mm tube to the 3-way stopcock.

4



Connect the Luer-lock-adaptor of the 3-way stopcock with the Sample-in-connector.

5

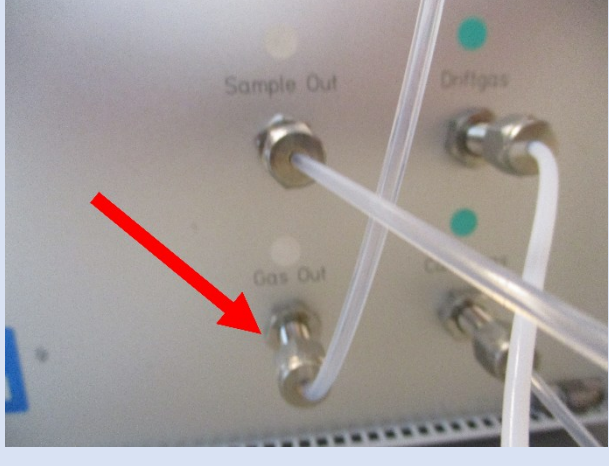

Connect Swagelock connector of the 3 mm tube with the Gas-out-connector.

6

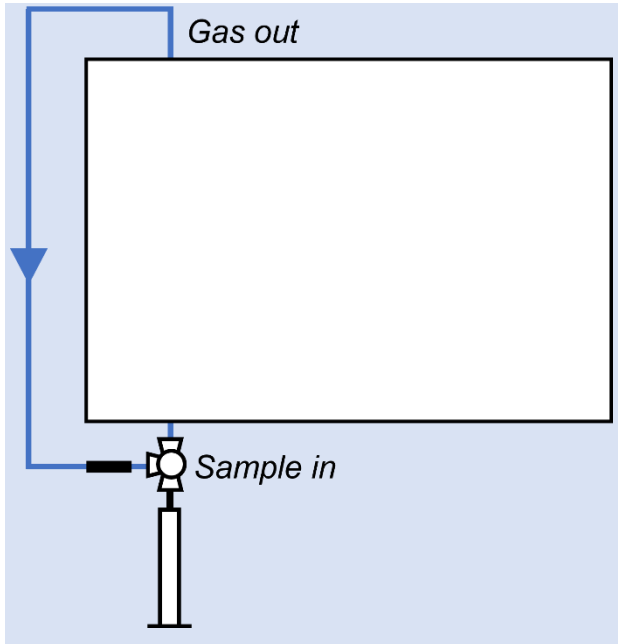

Schematic illustration of the connection

7

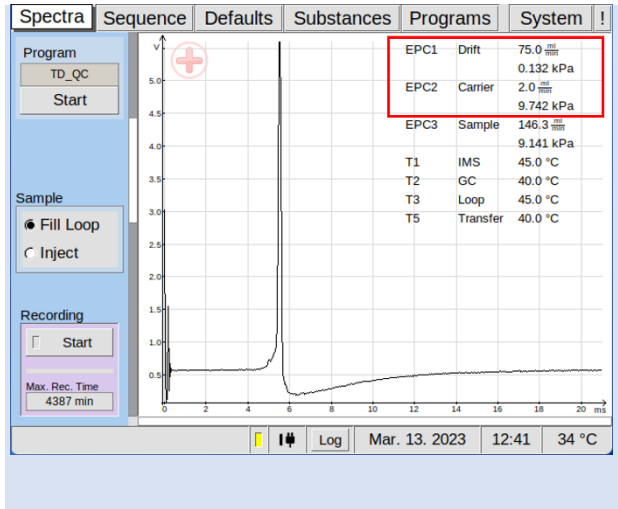

Read the current flow settings of EPC\_IMS and EPC\_GC and calculate the sum of both values.  
  
The set pump power at the sample-in input must be less than 75% of the sum of the set sum of EPC\_IMS and EPC2 flow.

8

A photograph of a document with a table. The table is highlighted with a red box.

Setting of the pump [%]	Gas flow "Sample In" [mL/min]
10	~35
30	~165
50	~284
100	~500

Get the 10% Sample-In flow setting from the Analytical Approval.

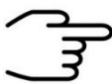

**INFORMATION!**

It is recommended to set the pump capacity to 10%, which corresponds to a flow of approx. 40 ml/min (the exact value can be found in the Analytical Approval).

## 10 Appendix

### 10.1 Technical data: BreathSpec®

<b>Dimensions</b>	<ul style="list-style-type: none"><li>• Housing: 19"-compatible</li><li>• Height: 184.5 mm</li><li>• Width: 449 mm</li><li>• Depth 435 mm</li><li>• Weight: ca. 15 kg</li></ul>
<b>Operational conditions</b>	<ul style="list-style-type: none"><li>• Temperature range: +5°C ... +40°C</li><li>• Humidity: 0-90% RH, non-condensing</li></ul>
<b>Electrical Connectors</b>	<ul style="list-style-type: none"><li>• 2 x RS232 DE9 plug</li><li>• 1 x I/O DA15 socket</li><li>• 1 x Ethernet RJ45 IEEE 802.3 100BASE-T</li><li>• 1 x USB 2.0 Host (USB A Connector)</li><li>• 1 x XLR 3-pole male, for power supply</li></ul>
<b>Power Supply</b>	<ul style="list-style-type: none"><li>• Input line voltage: Grounded AC, 85 to 264V</li><li>• Input line frequency: 47-63 Hz</li><li>• Input current: &lt;2.8 A</li><li>• Output voltage: 24 VDC</li><li>• Output current: 9.2 A internal</li><li>• Power consumption: &lt;221 Watt</li></ul>
<b>Cooling</b>	<ul style="list-style-type: none"><li>• Axial ventilator, temperature-controlled, max. 5.5 m<sup>3</sup>/h</li></ul>
<b>Gas connectors</b>	<ul style="list-style-type: none"><li>• 3 mm stainless steel Swagelok-connector.</li></ul>
<b>Internal hoses</b>	<ul style="list-style-type: none"><li>• PFA</li></ul>

<b>IMS-parameters</b>	<ul style="list-style-type: none"> <li>• Drifttube length: 53 mm</li> <li>• Electrical field strength: 500 V/cm</li> <li>• Resolution: ~ 45</li> <li>• Operating temperature: 35–80°C</li> </ul>
<b>Ionisation source</b>	<ul style="list-style-type: none"> <li>• Radioactive - Tritium H<sup>3</sup> (β<sup>-</sup> Radiation)</li> </ul>
<b>Data acquisition</b>	<ul style="list-style-type: none"> <li>• Sample-Rate: 150 kHz</li> <li>• Resolution: 14 bits</li> <li>• Trigger-duration: 100 μs</li> <li>• Trigger-repetition rate: 21 ms</li> </ul>
<b>Drift voltage</b>	<ul style="list-style-type: none"> <li>• 2,7 kV Positive/negative Driftvoltage switchable</li> </ul>
<b>Sampling system</b>	<ul style="list-style-type: none"> <li>• 6-port-valve</li> <li>• Sample loop: 1 mL (other volumes available on request)</li> <li>• Operation temperature: 35 – 80°C (default 45°C)</li> <li>• Temperature display accuracy: ± 1°C</li> <li>• Temperature control accuracy: ± 0,1 K</li> </ul>
<b>Data storage</b>	<ul style="list-style-type: none"> <li>• Internal storage volume</li> <li>• Data transfer via LAN-connection via SMB, SFTP or TFTP (G.A.S. variant of TFTP)</li> </ul>
<b>Operation</b>	<ul style="list-style-type: none"> <li>• 6.4" TFT Touchscreen</li> <li>• Pushable rotary knob</li> </ul>
<b>Standard Gaschromatic Capillary Column (Other Column types only on request)</b>	<ul style="list-style-type: none"> <li>• <b>Standard Stationary Phase:</b> <ul style="list-style-type: none"> <li>• (Polyethylene glycol)</li> </ul> </li> <li>• <b>Capillary column</b> <ul style="list-style-type: none"> <li>• Identification: MXT-WAX</li> <li>• Film thickness: 0,5 μm</li> <li>• Column length: 30 m</li> <li>• ID: 0.53 mm</li> <li>• OD: 0.68 mm</li> </ul> </li> </ul>

<b>Column oven</b>	<ul style="list-style-type: none"><li>• Operation temperature: 35 – 80°C</li><li>• Temperature-display accuracy: <math>\pm 1^\circ\text{C}</math></li><li>• Temperature-control accuracy: <math>\pm 0.1^\circ\text{C}</math></li></ul>
<b>Flow Control EPC_IMSEPC_IMS Driftgas</b>	<ul style="list-style-type: none"><li>• Type: Differential pressure control</li><li>• Input Pressure: 3.0 bar (300 kPa) – 6.0 bar (600 kPa)</li><li>• Output Pressure Stability: 0.01%</li><li>• Output Pressure Linearity: 0.05%</li><li>• Operation flow rates: 0 – 500 ml/min</li></ul>
<b>Flowcontrol EPC_GC Carriergas</b>	<ul style="list-style-type: none"><li>• Type: Differential pressure control</li><li>• Input Pressure: 3.0 bar (300 kPa) – 6.0 bar (600 kPa)</li><li>• Output Pressure Stability: 0.01%</li><li>• Output Pressure Linearity: 0.05%</li><li>• Operation flow rates: 0 – 150 ml/min (depending on the GC-Column dimensions)</li></ul>
<b>Consumables</b>	<ul style="list-style-type: none"><li>• Gas nitrogen 5.0 quality or Synthetic air 5.0 quality</li></ul>
<b>Cleaning mode</b>	<ul style="list-style-type: none"><li>• IMS, column and sampling system are heated up to <math>&gt;80^\circ\text{C}</math> (<math>\sim 100^\circ\text{C}</math>).</li></ul>

## 10.2 Technical data: I/O Interface

Device Connector Specification		
<b>Analog output</b>	Output type  Non-loaded voltage Maximum output signal Maximum output load (burden resistance) Accuracy Linearity error  Temperature coefficient Output Ripple (RMS)	Isolated active current output 0-22 mA <20 V <25 mA 500 Ohm  better than 0.5% <10 µA (guaranteed monotonic) <1µA/K (t.b.d. <10 µA)
<b>Digital input</b>	Input type Off-state voltage On-state voltage Input current	Isolated opto-coupler input <1 V 5 .. 30 V <20 mA depending on input voltage
<b>Digital output</b>	Output type  Maximum open circuit voltage Maximum on-state saturation voltage Maximum on-state current	Isolated passive transistor output  30 V 2 V  20 mA
<b>Relais output</b>	Contact material Rated current Switching power Max. Switching voltage Min. Recommended contact load	AgPd alloy 0.1 A 12 VA, 3 W 24 V DC, 120 V AC 1 mA at 1 V DC

<b>Isolation</b>	Isolation type <sup>1</sup>  Surge voltage category Pollution degree Rated insulation voltage  <hr/> <sup>1</sup> All in-/outputs are isolated from instrument	basic insulation according to EN 61010  II 2  100 V DC or 100 Vrms AC
------------------	--	--

**Device Connector Pinout**

<b>Connector type</b>	D-Sub DA-15 female	
<b>Analog output</b>	Return <sup>2</sup> Internal shunt Current output  <hr/> <sup>2</sup> PIN 1 is common return for both analog outputs and for digital transistor output	Pin 1 Pin 2 Pin 9
<b>Digital input</b>	Negative Positive	Pin 4 Pin 5
<b>Digital output</b>	Negative <sup>3</sup> Positive  <hr/> <sup>3</sup> Pin 1 is common return for both analog outputs and for the digital transistor output	Pin 1 Pin 6
<b>Relais output</b>	Common NC NO	Pin 11 Pin 3 Pin 13



**INFORMATION!**

- Relais is energized if no fault was detected.
- Relais will de-energized not later than 40 seconds after MCU failure
- Availability of I/O is device dependent.
- Do not connect any other pins.

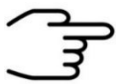

**INFORMATION!**

- If an external trigger is inserted into the run of a triggered running measurement is applied, it is completely ignored.

A MessageBox with Time(s) of occurrence is displayed and must be confirmed.

- None Error output via current loop or digital output. Only via Modbus, a bit is set for "external error" (error codes) at current measurement.
- On the BreathSpec the current measurement remains unaffected by this.

### 10.3 Ionisation Source Specification



**INFORMATION!**

The permission and exemption limits are regulated by the Radiation Protection Ordinance and the European Union Council Directive 96/26/EURATOM in accordance with the regulations of the International Atomic Energy Authority (IAEA).

**Source Type**

**Tritium H<sup>3</sup>, Solid-state bonded**

<b>Activity</b>	Below the exemption limit of 1 GBq for tritium acc. to Table B (column 2) of Article 26, of the Directive 2013/59 EURATOM of December 5 <sup>th</sup> , 2013
<b>Radiation Type</b>	<b>β<sup>-</sup>-Radiation</b>
<b>Radiation Energy</b>	<b>Average energy: 5.68 keV</b> Maximum energy: 18.7 keV
<b>Full Duration Half Maximum (FDHM)</b>	<b>12.3 years</b>
<b>Bracking radiation</b>	<b><math>2 \times 10^{-7}</math> (mSv / h x GBq)</b> $H_{\text{Brake}} = A \times h_{\text{Br}} \times (1\text{m} / r)^2$ $h_{\text{Br}} = 0.257 \times 10^{-4} \times (E_{\beta\text{max}} / \text{MeV}) \times 2$
<b>Attenuation of Radiation</b>	<b>Air: 4 mm</b> Water: <100 μm Tissue: <100 μm  Below the exemption limit of a dose rate of 1 μSv/h at a distance of 0.1 m from any accessible surface of the apparatus acc. to Article 26, of the Directive 2013/59 EURATOM of December 5 <sup>th</sup> , 2013
<b>Mounting Location and Type</b>	<b>Fixed inside the device and not accessible from the outside. The source cannot be touched directly.</b>

### 10.4 Technical drawing: Internal Gasflow

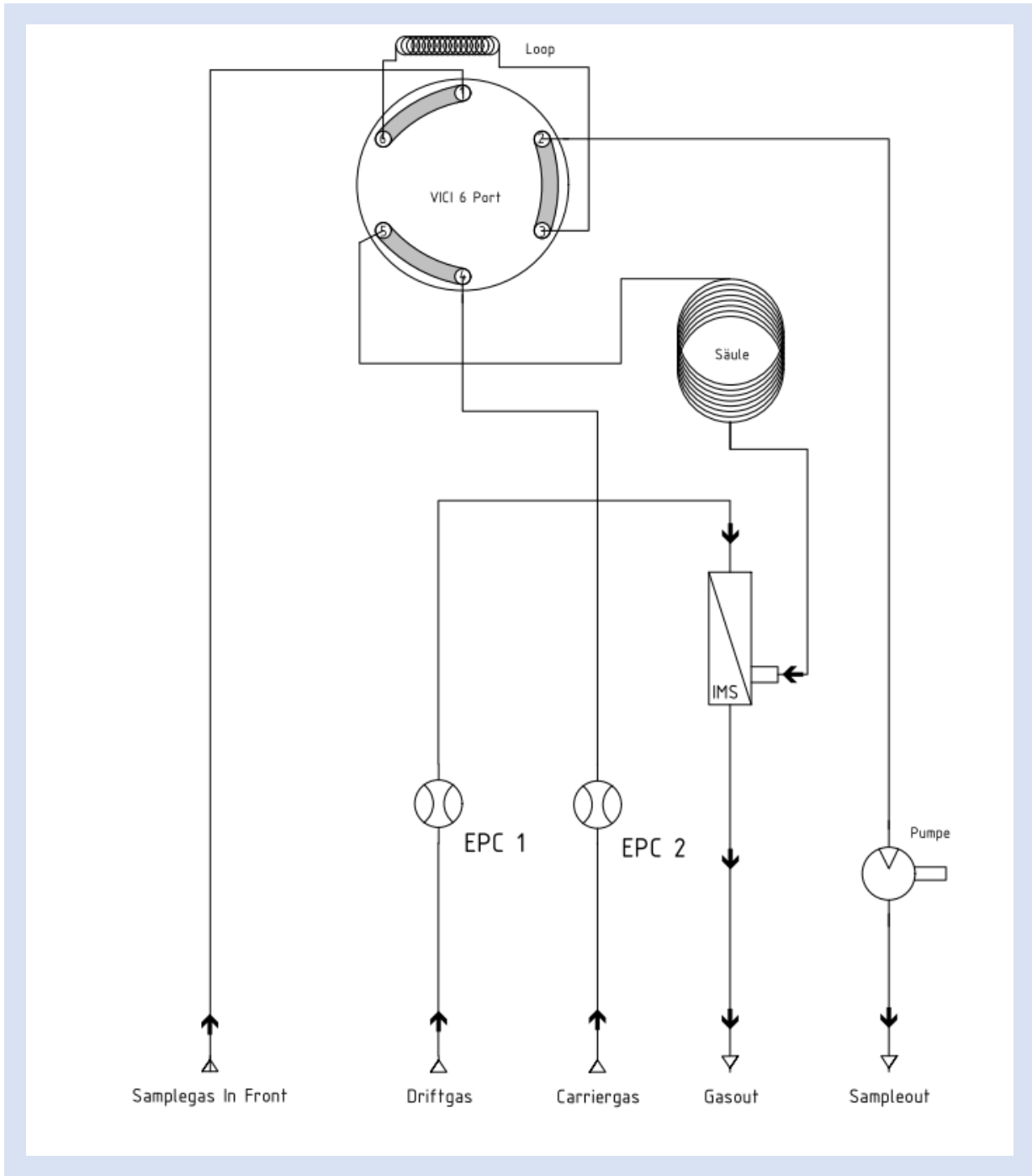
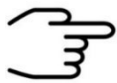

Figure 86: The gas flow diagram

## 10.5 Current Loop Interface (optional)

<b>Output Type</b>	Isolated active current output 0-20 mA
<b>Non-loaded Voltage</b>	<20 V
<b>Maximum Output Signal</b>	<22 mA
<b>Maximum Output Load (burden resistance):</b>	500 Ohm
<b>Accuracy</b>	Better than 1%
<b>Connector Type</b>	D-Sub DA-15 female
<b>Used Pins</b>	Current output 1: Pin 9 Current output 2: Pin 2 Return: Pin 1



### INFORMATION!

- Do not connect any other pins.

### Current Loop Settings Values (Min, Max, Default and Example Values)

<b>Result Value-Range</b>	Min 0 mA, Max 20 mA (Default: 4,0 mA – 20 mA)
<b>DAC-Range</b>	Depending on Current Loop generation
<b>Error Value</b>	Min 0 mA – Max 1024 mA (Example: 22 mA – 981 mA)

**Idle Value**

Min 0 mA – Max 65535 mA (Example: 20 mA – 54559 mA)

**10.6 Modbus TCP Specification****Register Layout**

Offset	Register	Content
1-6	40001-40006	<b><u>Header Information</u></b> for the <b><u>latest results</u></b> .
7-125	40007-40125	The <b><u>latest results</u></b> are mapped to these registers.
126-132	40126-40132	<b><u>Header information</u></b> for the <b><u>previous results</u></b>
133-250	40133-40250	The <b><u>previous results</u></b> are mapped these registers.

**Registers in Header**

Register	Datatype	Information
1	16 bit unsigned Integer	The amount of <b>results</b> that are available.
2	16 bit unsigned Integer	A 16 bit encoded <b>error code</b> . For the possible errors <b>see <a href="#">Error Codes page 216</a></b> . In case of multiple errors, the error codes are added together.

3	32 bit unsigned Integer	<b>Time</b> in seconds since 01.01.1970 00:00 encoded into a 32 bit Integer split up into this and the following register. Contains the two least significant bits.
4		Second part of the encoded <b>time</b> from register 3. Contains the two most significant bits.
5	Unused	
6	Unused	

**Substance at Register *n***

Register	Datatype	Information
n	32 bit unsigned Integer	The <b>concentration</b> (multiplied by 1000 for a possible three decimal point <b>precision</b> ) encoded into a 32 bit Integer split up into this and the following register. The unit for this concentration is specified in the corresponding calibration and can be seen in Substance window of your device. The precision of this calculated value can be looked up in the corresponding calibration protocol for this substance. Contains the two least significant bits.

n+1		Second part of the encoded <b>concentration</b> (multiplied by 1000 for a possible three decimal point precision) from register n. Contains the two most significant bits.
n+2	16 bit unsigned Integer	Shows you whether the substance has been <b>enabled (=1)</b> or <b>disabled (=2)</b> for evaluation.
n+3	16 bit unsigned integer	A 16bit encoded status of the substance result. <b>See Status codes pages 216</b> for further information.
n+4	-	Unused
n+5	-	Unused

## Error codes

Bit	Value	Information
	0	<b>No Error</b>
0	1	<b>Unknown Error.</b> Source of Error unknown.
1	2	Error concerning <b>current</b> . Only used in special applications.
2	4	The <b>temperature</b> of a component has not reached the designated value

## BreathSpec® – User Manual

3	8	The <b>flow</b> of one or more pressure controllers has not reached the designated value
4	16	<b>Storage</b> problems. E.g. cannot write to the device
15	32768	Multiple Trigger

### Status codes

Bit	Value	Information
0	1	Concentration <b>within range</b>
1	2	Concentration is <b>below</b> the calibrated range
2	4	Concentration is <b>above</b> the calibrated range
3	8	<b>Invalid</b>
3-15	16-32768	<b>Unused</b>

## 10.7 Troubleshooting

### 10.7.1 Error message list

<b>Error message</b>	<b>Drift voltage supply.</b>
<i>Description</i>	<i>Drift voltage error</i>
Action	Fatal Error! Contact the G.A.S. service hotline.
<b>Error message</b>	<b>Can't save measurement.</b>
<i>Description</i>	<i>The measurement file could not be saved to the internal memory.</i>
Action	Export and save all Measurement of the internal storage and clear the storage. Repeat the procedure. If that still does not help contact the G.A.S. service hotline.
<b>Error message</b>	<b>smb connection failed:</b>
<i>Description</i>	<i>Samba (Service Message Block SMB) connection failed.</i>
Action	Check network cable, network shares and IP-address. Repeat the procedure. If that still does not help contact the G.A.S. service hotline.
<b>Error message</b>	<b>sftp connection failed:</b>
<i>Description</i>	<i>Secure File Transfer Protocol (SFTP) connection failed.</i>
Action	Check network cable, network shares and IP-address. Repeat the procedure. If that still does not help contact the G.A.S. service hotline.
<b>Error message</b>	<b>No USB-Storage found.</b>
<i>Description</i>	<i>Mounting of the USB-Stick failed.</i>
Action	Ensure that a USB-Stick is insert. Ensure that the USB-Stick is FAT32 formatted. Reformat the USB-Stick. Replace the USB-Stick with a new one. If that still does not help contact the G.A.S. service hotline.

<b>Error message</b>	<b>Unable to unmount USB-Storage.</b>
<i>Description</i>	<i>Unmounting of the USB-Stick failed.</i>
Action	Remove the USB-Stick and restart the device. Check the USB-Stick, optionally reformat it. Insert the USB-Stick and repeat the procedure. If that still does not help contact the G.A.S. service hotline.
<b>Error message</b>	<b>No program selected.</b>
<i>Description</i>	<i>At program start no program was detected</i>
Action	Create and select a program. Repeat the procedure. If that still does not help contact the G.A.S. service hotline.
<b>Error message</b>	<b>Drift gas flow too low. Aborting...</b>
<i>Description</i>	<i>At program start the drift gas flow is too low. Programstart will be refused.</i>
Action	Increase the back pressure. Repeat the procedure. If that still does not help contact the G.A.S. service hotline.
<b>Error message</b>	<b>Stop recording first.</b>
<i>Description</i>	<i>If recording is activ a programstart is refused.</i>
Action	Deactivate recording and repeat the procedure. If that still does not help contact the G.A.S. service hotline.
<b>Error message</b>	<b>Can't initialize drift supply. Program can not be started.</b>
<i>Description</i>	<i>Drift voltage error</i>
Action	Fatal Error! Contact the G.A.S. service hotline.
<b>Error message</b>	<b>Invalid program.</b>
<i>Description</i>	<i>The selected program has no instructions.</i>
Action	Complete the program and repeat the procedure. If that still does not help contact the G.A.S. service hotline.







<b>Error message</b>	<b>Not enough storage space left. Please delete or copy measurement or choose a shorter program.</b>
<i>Description</i>	<i>The internal storage has not enough storage space left.</i>
Action	Export and save all Measurement of the internal storage and clear the storage. Repeat the procedure. If that still does not help contact the G.A.S. service hotline.
<b>Error message</b>	<b>Hardware access failure</b>
<i>Description</i>	<i>Error when switching the drift voltage polarity.</i>
Action	Fatal Error! Contact the G.A.S. service hotline.
<b>Error message</b>	<b>Valve set to Inject. Loop not filled! Proceed? OK or Cancel</b>
<i>Description</i>	<i>Valve start position is set to Inject instead of Fill loop.</i>
Action	Set valve start position manually to Fill loop. Repeat the procedure. If that still does not help contact the G.A.S. service hotline.
<b>Error message</b>	<b>Can't import calibration.gsd</b>
<i>Description</i>	<i>The file „calibration.gsd“ was not found.</i>
Action	Create the file „calibration.gsd“ and import it with an USB-Stick. Repeat the procedure. If that still does not help contact the G.A.S. service hotline.
<b>Error message</b>	<b>No measurements stored.</b>
<i>Description</i>	<i>No measurements stored on the internal storage.</i>
Action	Do a measurement. Repeat the procedure. If that still does not help contact the G.A.S. service hotline.
<b>Error message</b>	<b>Folder cannot be created :</b>
<i>Description</i>	<i>When exporting the device subfolder could not be created.</i>

Action	Check the external storage. Check network cable, network shares and IP-address. Check write protection of the USB-Stick. Ensure that the USB-Stick is FAT32 formatted. Reformat the USB-Stick. Replace the USB-Stick with a new one. Repeat the procedure. If that still does not help contact the G.A.S. service hotline.
<b>Error message</b>	<b>No measurement files transferred</b>
<i>Description</i>	<i>No measurement are transferred to an external storage.</i>
Action	Check the external storage. Check network cable, network shares and IP-address. Check write protection of the USB-Stick. Ensure that the USB-Stick is FAT32 formatted. Reformat the USB-Stick. Replace the USB-Stick with a new one. Repeat the procedure. If that still does not help contact the G.A.S. service hotline.
<b>Error message</b>	<b>No measurements stored.</b>
<i>Description</i>	<i>No measurements were deleted, because no measurements are available.</i>
Action	Do a measurement. Repeat the procedure. If that still does not help contact the G.A.S. service hotline.
<b>Error message</b>	<b>RTC read error.</b>
<i>Description</i>	<i>Date and time setting failed.</i>
Action	Restart the system and repeat the procedure. If that still does not help contact the G.A.S. service hotline.
<b>Error message</b>	<b>Save settings failed.</b>
<i>Description</i>	<i>Setting data could not be save on a USB-stick.</i>
Action	Check write protection of the USB-Stick. Ensure that the USB-Stick is FAT32 formatted. Reformat the USB-Stick. Replace the USB-Stick with a new one. Repeat the

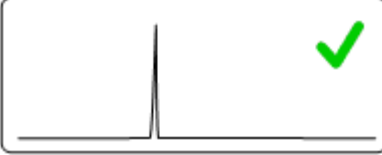
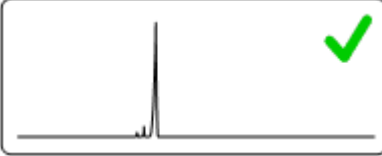
	procedure. If that still does not help contact the G.A.S. service hotline.
<b>Error message</b>	<b>Load settings failed.</b>
<i>Description</i>	<i>Setting data could not be load from a USB-stick</i>
Action	Repeat the procedure. Restart the system and repeat the procedure. Check write protection of the USB-Stick. Ensure that the USB-Stick is FAT32 formatted. Reformat the USB-Stick. Replace the USB-Stick with a new one. Repeat the procedure. If that still does not help contact the G.A.S. service hotline.
<b>Error message</b>	<b>Do you really want to relabel loop volume? It will be stored in all following measurements.</b>
<i>Description</i>	<i>Sample loop setting is change manually.</i>
Action	Confirm or abort the dialog.
<b>Error message</b>	<b>Can't set static ip!</b>
<i>Description</i>	<i>Setup of the static IP-address failed.</i>
Action	Check the network settings. Contact your administrator. Repeat the procedure. If that still does not help contact the G.A.S. service hotline.
<b>Error message</b>	<b>Can't request DHCP:</b>
<i>Description</i>	<i>Setup of the dynmaic IP-address failed.</i>
Action	Check the network settings. Check DHCP-server. Contact your administrator. Repeat the procedure. If that still does not help contact the G.A.S. service hotline.
<b>Error message</b>	<b>Valve set to Inject. Loop not filled</b>
<i>Description</i>	<i>Valve setting is set to position "Inject" and not to "Fill loop". Sample loop could not be filled.</i>
Action	Abort program and set valve to position „Fill loop“ manually.

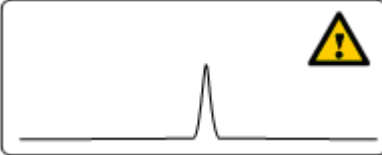
<b>Error message</b>	<b>Trigger recieved while running program.</b>
<i>Description</i>	<i>During the program run a new trigger signal will be received. The program run is aborted.</i>
Action	The device get a wrong trigger signal. Check the external trigger programming. Repeat the procedure. If that still does not help contact the G.A.S. service hotline.
<b>Error message</b>	<b>Stop recording first.</b>
<i>Description</i>	<i>When starting the trigger mode recording is activated.</i>
Action	Deactivate recording and repeat the procedure. If that still does not help contact the G.A.S. service hotline.
<b>Error message</b>	<b>Select program first.</b>
<i>Description</i>	<i>When starting the trigger mode no program is activated.</i>
Action	Select a program and repeat the procedure. If that still does not help contact the G.A.S. service hotline.
<b>Error message</b>	<b>Can't read calibration.gsd</b>
<i>Description</i>	<i>The import of the calibration.gsd. file failed. The file was not found.</i>
Action	Ensure that the file calibration.gsd exist and is placed in the measurement subfolder of the device. Check network cable, network shares and IP-address. Repeat the procedure. If that still does not help contact the G.A.S. service hotline.

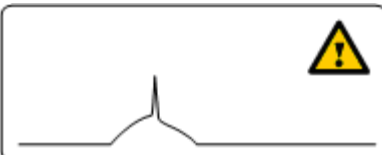
10.7.2 IMS-Spectrum Examples

Schematic of IMS spectrum	Spectrum description	reasons / suggestions
	Clean spectrum	Perfect
	Clean spectrum, up to two extra signals left hand side of the RIP	Perfect
	RIP shifted to lower drift times	<ul style="list-style-type: none"> <li>- elevated temperature</li> <li>- reduced pressure</li> </ul>
	RIP shifted to higher drift times	<ul style="list-style-type: none"> <li>- low temperatures</li> <li>- elevated pressure</li> </ul>
	RIP deformed	<ul style="list-style-type: none"> <li>- gas quality out of specifications</li> <li>- device needs to be flushed for some time</li> <li>- flows not in range</li> </ul>
	RIP base deformed yet visible	<ul style="list-style-type: none"> <li>- gas quality out of specifications</li> <li>- device needs to be flushed for some time</li> <li>- flows not in range</li> </ul>
	RIP deformed towards tailing	<ul style="list-style-type: none"> <li>- gas quality out of specifications</li> <li>- device needs to be flushed for some time</li> <li>- flows not in range</li> </ul>

BreathSpec® – User Manual

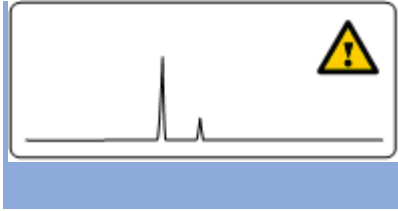

Minor impurities

- gas quality out of specifications
- device is polluted > run system cleaning

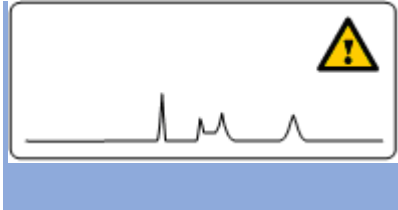

Major impurities

- gas quality out of specifications
- device is polluted > run system cleaning

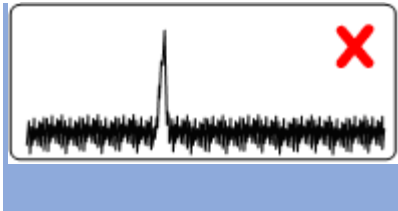

Elevated noise

Contact G.A.S. support



No signal

Contact G.A.S. support

## 10.7.3 Troubleshooting / How to...

**INFORMATION!**

This chapter is a collection of possible practical problems and serves as a guide for making an initial assessment. It makes no claim to completeness.

<b>Symptom</b>	<b>Device does not start</b>
<i>Possible Cause</i>	<i>Problem with the electrical power supply</i>
Action	Check the current power supply and restart the system. If that still does not help contact the G.A.S. service hotline.
<b>Symptom</b>	<b>Device freezes during start procedure.</b>
<i>Possible Cause</i>	<i>Problem with the Firmware</i>
Action	Restart the system. If that still does not help contact the G.A.S. service hotline.
<b>Symptom</b>	<b>Start procedure paused</b>
<i>Possible Cause</i>	<i>Hardware check during the start procedure</i>
Action	Wait up to 5 min. Normally the start procedure continues. Restart the system. If that still does not help contact the G.A.S. service hotline.
<b>Symptom</b>	<b>Temperature and/or gas flow values will not be displayed</b>
<i>Possible Cause</i>	<i>Problem with hardware/firmware communication</i>
Action	Restart the system. If that still does not help contact the G.A.S. service hotline.
<b>Symptom</b>	<b>Screen is black while device is on.</b>
<i>Possible Cause</i>	<i>Screensaver is active</i>

## BreathSpec® – User Manual

Action	Using the pushable rotary knob to active the screen. If the screen can't be reactivated then restart the system. If that still does not help contact the G.A.S. service hotline.
<b>Symtom</b>	<b>Gasflow set-values cannot be achieved.</b>
<i>Possible Cause</i>	<i>Backpressure to low</i>
Action	Set up the back pressure at least to 3 bar. If that still does not help contact the G.A.S. service hotline.
<i>Possible Cause</i>	<i>Hardware failure</i>
Action	Contact the G.A.S. service hotline.
<b>Symtom</b>	<b>Temperature set-values cannot be achieved.</b>
<i>Possible Cause</i>	<i>Hardware failure</i>
Action	Contact the G.A.S. service hotline.
<b>Symtom</b>	<b>No display of measurement values during monitoring</b>
<i>Possible Cause</i>	<i>Hardware failure</i>
Action	Contact the G.A.S. service hotline.
<b>Symtom</b>	<b>No Reaction Ion Peak (RIP) will be displayed.</b>
<i>Possible Cause</i>	<i>Device is in negative mode</i>
Action	Switch the drift voltage into positive mode. If that still does not help contact the G.A.S. service hotline.
<i>Possible Cause</i>	<i>Hardware failure</i>
Action	Contact the G.A.S. service hotline.
<b>Symtom</b>	<b>No or small Reaction Ion Peak (RIP) will be displayed.</b>
<i>Possible Cause</i>	<i>Insufficient gas quality</i>
Action	Check quality of operating gas (5.0 or better) and use moisture trap.
Action	When using the CGFU-unit, replace the CGFU-filters.

<i>Possible Cause</i>	<i>System contamination</i>
Action	Start cleaning mode.
<b>Symptom</b>	<b>Find signals from the prior measurement run in the chromatogram</b>
<i>Possible Cause</i>	<i>The measurement runtime is too short.</i>
Action	Increase the measurement run time
<b>Symptom</b>	<b>The actual size of the measurement file is too large</b>
<i>Possible Cause</i>	<i>Average setting too low.</i>
Action	Increase the Average setting or shorten the runtime (recommended averaging: 6).
<b>Symptom</b>	<b>The measurement signals cannot be mapped well.</b>
<i>Possible Cause</i>	<i>Average setting is too high.</i>
Action	Decrease the Average setting (recommended averaging: 6).
<b>Symptom</b>	<b>EPC_GC Maximum flow of 150 ml/min is not reached.</b>
<i>Possible Cause</i>	<i>The reachable maximum flow depends on the dimensions of the installed column.</i>
Action	Get the specified maximum flow from Analytical approval. If that still does not help contact the G.A.S. service hotline.
<i>Possible Cause</i>	When using a CGFU unit the total flow (EPC_IMSEPC_IMS and EPC_GC) is limited to 400 ml/min.
Action	No Action
<b>Symptom</b>	<b>Six-Port-valve doesn't switch</b>
<i>Possible Cause</i>	<i>Lost connection</i>
Action	Restart the system. If that still does not help contact the G.A.S. service hotline.
<b>Symptom</b>	<b>Six-Port-valve switching noise sounds strange</b>
<i>Possible Cause</i>	<i>Initialization lost</i>

## BreathSpec® – User Manual

Action	Reinitializes the Six-Port-Valve
<b>Symptom</b>	<b>No sample signals are displayed during a measurement.</b>
<i>Possible Cause</i>	<i>Sample-Pump has failed</i>
Action	Set pump capacity to 100%. The pump device must be audible loud. Turn the pumping power back to the working flow. In addition, the flow can be measured using a flowmeter at the sample inlet and outlet. If that still does not help change sample pump.
<b>Symptom</b>	<b>Drift time fluctuates</b>
<i>Possible Cause</i>	<i>System is untight</i>
Action	Check all gas supply connections of operating gas.
Action	Check all gas supply connections of GC-column.
<b>Symptom</b>	<b>Retention time fluctuates</b>
<i>Possible Cause</i>	<i>System is untight</i>
Action	Check all gas supply connections of operating gas.
Action	Check all gas supply connections of GC-column.
<b>Symptom</b>	<b>CGFU does not start</b>
<i>Possible Cause</i>	<i>The pressure in the system has not yet been reduced. The pump cannot start if the back pressure is too high.</i>
Action	If the BreathSpec is turned off, wait a minimum of 10 minutes before restarting as otherwise the CGFU pump will not start due to overpressure within the system.

## 10.8 Consumables / Spare Parts



**Part number: 100001817**

Power supply with Power plug



**Part number: 100002092**

Gas tube Kit: (BreathSpec 5G1)

- Driftgas/Carriergas Adapter with 0,15 m PFA-Tubes with 3 mm Swagelok Connectors (1piece)
- 0,65 m 3 mm PFA Tubes with 3 mm Swagelok-Connector (2 Pieces)
- 2 m 3 mm PFA Tubes with 3 mm Swagelok-Connector (2 Pieces)



**Part number: 100002093**

Gas tube Kit: (BreathSpec 5G2)

- Driftgas/Carriergas Adapter with 0,15 m PFA-Tubes with 3mm Swagelok Connectors (1piece)
- 0,65 m 3 mm PFA Tubes with 3 mm Swagelok-Connector (2 Pieces)
- 2 m 3 mm PFA Tubes with 3 mm Swagelok-Connector (6 Pieces)

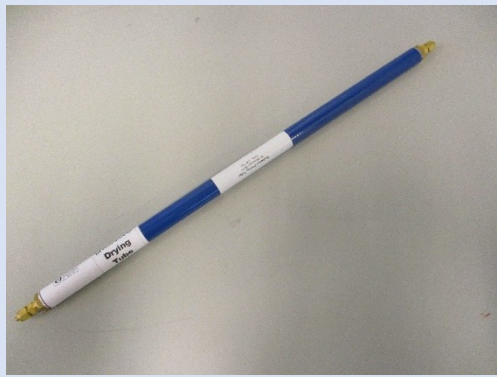

**Part number: 100001094**

Molecular sieve 200 ml with 1/8" connections

**(Labuse)**



**Part number: 100001998**

Molecular sieve 120 ml with 1/8" connections

**(Attachable to device)**



**Part number: 100001902**

Standard-capillary column MXT-WAX  
Lenght 30 m, ID 0,53 mm, Film thickness 0,5  
 $\mu\text{m}$ , Winding ID 80 mm  
(1 piece)

**(Other column types only on request)**



**Part number: 100001170**

Peek Ferrules for capillary column with ID  
0,53 mm  
Connection 1/16", Hole 0,8 mm,



**Part number: 100002090**

LAN Cable



**Part number: 100000934**

Blind plug Set (5 pieces)



**Part number: 100002003**

Custom Ketones Standard



**Part number: 100001216**

Torx Tool Kit

- Torx Screwdriver 8 mm
- Torx Screwdriver 10 mm

## BreathSpec® – User Manual



**Part number: 100001211**

Torx Screwdriver 30 mm (1 piece)



**Part number: 100001547**

CGFU Connection cable (1 piece)



**Part number: 100001874**

GC-IMS Transport box Length = 75 cm,  
Height = 30 cm, Width = 59 cm

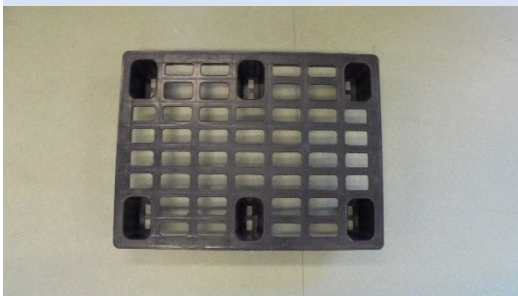

**Part number: 100001882**

GC-IMS Transport palette (60 x 80 cm)

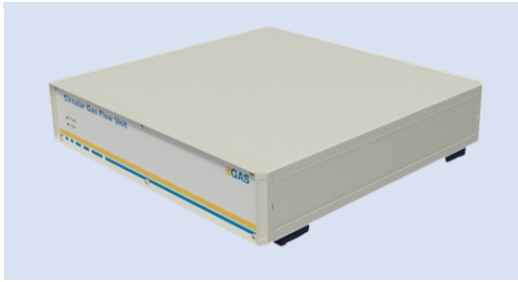

**Part number: 100002110**

Circular Gas Flow Unit with accessories



**Part number: 100001999**

Circular Gas Flow Unit exchange filter set.



**Part number: 100001815**

Circular Gas Flow Unit pump.



**Part number: 100001957**

Nitrogen Generator with accessories  
(example picture)

## BreathSpec® – User Manual



**Part number: 100001714**

μTD with accessories



**Part number: 100002131**

Laptop Computer (different design) including software for control and evaluation



**Part number: 100001992**

Sampling Syringe 5 ml syringe for Luer Adapter) (100 pieces)



**Part number: 100002478**

- Reservoir tube (100 pieces)



**Part number: 100001981**

- Mouthpieces (100 pieces) different colour possible



**Part number: 100001993**

Inner Syringe Body (2 ml syringe) (50 pieces)



**Part number: 100001816**

Sample pump

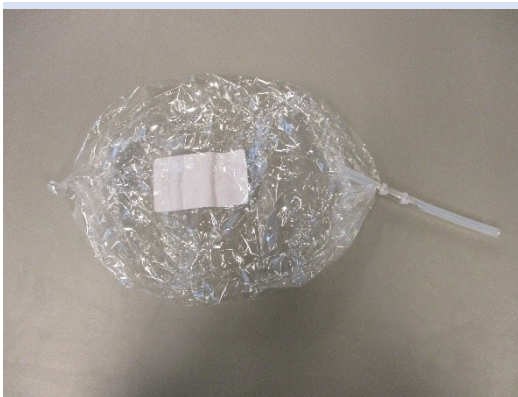

**Part number: 100002004**

Sampling Bag 1 liter (10 pieces)

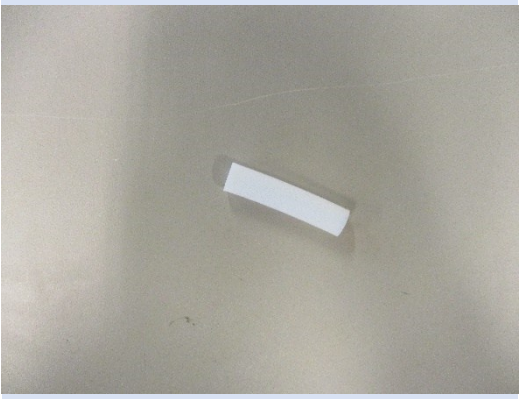

**Part number:**  
Sampling Bag Adapter (10 pieces)

## 10.9 Corresponding G.A.S. Documents and Tutorials



### INFORMATION!

- BreathSpec Quickstart Manual
- CGFU User Manual (optional)
- Airsense uTD Handbook (optional)
- $\mu$ TD GC-IMS Additional Information Quickstart (optional)
- Sequence Designer Manual
- IMS Control TFTP-Server Manual
- Tutorials Sequence Designer
- Tutorials VOCal
- Manuals VOCal

## 10.10 Table of Figures

Figure 1: Ion Mobility Spectrometer - Basic Relations .....	27
Figure 2: Ion Mobility Spectrometer -Working Principle .....	28
Figure 3: IMS Predominant Ionization (positive polarization) .....	29
Figure 4: Protone Affinities of VOC's .....	29
Figure 5: GC-IMS measurement 3D .....	30
Figure 6: Schematic of the sample- and drift gas flow paths .....	31
Figure 7: Chromatograms of 2-ketones (C 4-9) for varying drift gas flows .....	32
Figure 8: BreathSpec® device plan (exemplary) .....	35
Figure 9: Six-Port Valve - Position Fill Loop and Inject .....	36
Figure 10: BreathSpec® (Version 5G1) - Housing of device - Front.....	38
Figure 11: BreathSpec® (Version 5G1) - Housing of device - Rear .....	40
Figure 12: BreathSpec® with Airsense µTD (Version 5G2) - Housing of device - Top .....	42
Figure 13: BreathSpec® (Version 5G2) with Airsense µTD - Housing of device - Front .....	43
Figure 14: BreathSpec® (Version 5G2) with Airsense µTD - Housing of device - Rear .....	45
Figure 15: Device Type / Serial Number Plate.....	47
Figure 16: Operating Interface - Overview.....	49
Figure 17: Operating Interface - Windows Selection Bar .....	50
Figure 18: Operating Interface - Status Bar .....	51
Figure 19: Operating Interface – View Control Bar .....	52
Figure 20: Operating Interface - Low Pressure Alarm Box .....	53
Figure 21: Operating Interface - High Pressure Alarm Box .....	54
Figure 22: Operating Interface - Spectra Window.....	55
Figure 23: Start Program .....	56
Figure 24: Recording Check Box.....	57
Figure 25: Recording Check Box.....	57
Figure 26: Operating Interface - Sequence Window .....	58
Figure 27: Operating Interface - Sequence Window - Processing .....	59
Figure 28: Operating Interface - Defaults Window .....	61
Figure 29: Drift Voltage Windows - positive and negative Mode.....	64
Figure 30: Flow Control (Example) .....	64
Figure 31: Temperatures Control (Example) .....	64
Figure 32: Operating Interface - Substances Window .....	65
Figure 33: Substance List Control panel.....	66
Figure 34: Substance List Control panel.....	67
Figure 35: Substance selection 1 .....	67
Figure 36: Substance selection 2 .....	68
Figure 37: Substance selection 3 .....	68
Figure 38: Substances Window .....	69
Figure 39:Information about the last Modbus TCP Connection .....	69
Figure 40:32 bit split up into 16 bit registers .....	70
Figure 41: First 25 registers of an example Modbus result. ....	71
Figure 42: Substance Calibration Information Area .....	71
Figure 43: Recognized Substances Window .....	73
Figure 44: Operating Interface - Programs Window .....	74

Figure 45: Program Control Panel .....	76
Figure 46: Selected Program Window .....	78
Figure 47: Selected Program area Control Panel .....	79
Figure 48: Program Action Editor .....	80
Figure 49: Program Action View .....	82
Figure 50: Flow Ramps .....	83
Figure 51: Operating Interface - System Window .....	85
Figure 52: Operating Interface - System Info Window .....	86
Figure 53: Operating Interface - System Plan Window .....	87
Figure 54: Operating Interface - System Settings Windows 1 .....	88
Figure 55: Operating Interface - System Settings Windows 2 .....	89
Figure 56: Operating Interface - System Settings Windows 3 .....	91
Figure 57: Operating Interface - System Settings Windows 4 .....	92
Figure 58: Operating Interface – Snapshot Window .....	94
Figure 59: Operating Interface – Snapshot Window in detail (example EPC_GC pressure) .....	95
Figure 60: Operating Interface – Column Data Editor Window .....	97
Figure 61: Column Selection Window .....	98
Figure 62: EPC Settings Window .....	99
Figure 63: Operating Interface - Simplified View Window .....	100
Figure 64: Operating Interface - System Transfer Window1 .....	101
Figure 65: Operating Interface - System Transfer Window2 .....	103
Figure 66: Example Stored Measurement file and CSV Report file .....	104
Figure 67: Operating Interface – Export Location Window .....	105
Figure 68: CSV Report file .....	106
Figure 69: Operating Interface - System Modes Window .....	107
Figure 70: Operating Interface - Trigger Mode Window .....	108
Figure 71: Operating Interface - Remote Mode Window .....	109
Figure 72: Operating Interface - Simplified View Window .....	110
Figure 73: Operating Interface - Cleaning Mode Window .....	111
Figure 74: Operating Interface - Standby Mode Window .....	112
Figure 75: Error Information Window .....	113
Figure 76: Log Messages Window .....	114
Figure 77: IP Adress Input Dialog Windows .....	115
Figure 78: Date and Time Input Dialog Window .....	116
Figure 79: Text Input Dialog Window .....	117
Figure 80: Number Input Dialog Window (Example) .....	118
Figure 81: Warm-up Cancelling Window .....	131
Figure 82: Spectra Window during the Warm-up Phase .....	131
Figure 83: Warm-up Cancelling Window .....	146
Figure 84: Spectra Window during the Warm-up phase .....	146
Figure 85: Schematics Current Loop .....	195
Figure 86: The gas flow diagram .....	243